

Prepared By:



Annual Monitoring Report (2023)

Chesley Waste Disposal Site
Municipality of Arran-Elderslie

MECP Certificate of Approval No. A272402

GMBP File: 219126

March 2024

TABLE OF CONTENTS

1. INTRODUCTION	1
2. GENERAL SITE OPERATIONS	2
2.1 Leachate Management.....	2
2.2 Surface Water Management	2
3. SUMMARY OF SITE SETTING	3
3.1 Site Setting	3
3.2 Landfill Property	3
3.3 Geologic Conditions	3
3.4 Hydrogeologic Conditions	4
3.4.1 Surface Water	4
3.4.2 Groundwater	4
4. RECYCLING/WASTE REDUCTION	5
5. WATER QUALITY MONITORING	5
5.1 Groundwater Monitoring Program.....	5
5.2 Surface Water Monitoring Program.....	6
5.3 Leachate Monitoring Program	6
5.4 Sampling Procedures	6
6. DETERMINATION OF REASONABLE USE CRITERIA FOR THE SITE.....	7
6.1 Determination of Action Levels.....	7
6.2 Background Groundwater Quality	7
6.3 Calculation of Objective Levels	8
6.4 Provincial Water Quality Objectives (Surface Water)	8
7. MONITORING RESULTS AND DISCUSSION	9
7.1 Leachate Monitoring	9
7.2 Groundwater Quality	10
7.2.1 Shallow Overburden	10
7.2.2 Deep Overburden	11
7.3 Surface Water	12
7.4 Water Quality Summary	13
8. 10-YEAR POST-CLOSURE MONITORING REVIEW	14
9. CONCLUSIONS	15
10. RECOMMENDATIONS	17

FIGURES

- Figure 1** Site Location Map and Landfill Property Boundary
- Figure 2** Site Plan Showing Monitoring Locations
- Figure 3** Spring Groundwater Flow Direction and Chloride Concentrations (April 2023)
- Figure 4** Fall Groundwater Flow Direction and Chloride Concentrations (November 2024)

TABLES

- Table 1** Site Specific Background Concentrations and Guideline B-7-1 RUC Determination
- Table 2** Summary of Groundwater Quality Data and Comparison to the RUC
- Table 3** Summary of Surface Water Quality Data
- Table 4** Summary of Leachate Collection System Quality Data

APPENDICES

APPENDIX A: CERTIFICATE OF APPROVAL NO. A272402

APPENDIX B: AVAILABLE TESTHOLE INFORMATION, WELL CONSTRUCTION DETAILS & CROSS-SECTIONS (WSP, MARCH 2019)

APPENDIX C: HISTORIC GROUNDWATER ELEVATION DATA 1992 TO PRESENT

APPENDIX D: GUIDELINE C-7 BURNING AT LANDFILL SITES (APRIL 1994)

APPENDIX E: SUMMARY OF GROUNDWATER ANALYTICAL RESULTS (TABLES & GRAPHS)

APPENDIX F: SUMMARY OF SURFACEWATER ANALYTICAL RESULTS (TABLES & GRAPHS)

APPENDIX G: SUMMARY OF MONTHLY LEACHATE ANALYTICAL RESULTS

APPENDIX H: LABORATORY CERTIFICATES OF ANALYSIS

**CHESLEY WASTE DISPOSAL SITE
ANNUAL MONITORING REPORT (2023)**

MARCH 2024

GMBP FILE: 219126

1. INTRODUCTION

The Chesley Landfill Site is described as Part of Lot 5, Registered Plan 236, Part of Lot 28, Concession 2 Parts of King and Spring Streets and Part of Lot 28, Concession 1, Municipality of Arran-Elderslie (former Town of Chesley, as shown on Figure 1. The site has the civic address of 230-4th Street Southwest, in the geographic village of Chesley, Ontario. The closed Chesley Landfill Site comprises an area of 6.4 hectares (15.8 acres), of which 2.4 hectares (5.9 acres) was approved for landfilling. The landfill site is currently maintained by the Corporation of the Municipality of Arran-Elderslie. The Municipality owns additional land to the west and north of the approved landfill site, which is occupied by a waste water treatment plant (sewage lagoons and associated operations building).

The Chesley Landfill site was in operation for approximately 40 years. Reportedly, the Landfill began accepting waste at the Site in the early 1970's and the landfill was closed to the public in 2013. A Provisional Certificate of Approval (CofA) for the waste disposal facility (CofA No. A272402) was issued to the Town of Chesley by the Ministry of the Environment, Conservation and Parks (MECP) on March 7, 1985, and was revised on June 7, 1991, January 30, 1998, May 21, 1998, April 11, 2000, March 15, 2005, and September 9, 2011. This Report has been prepared to satisfy Condition 50 of the C of A. A copy of the existing CofA and its amendment is provided in Appendix A.

A Plan of Development and Operations (PDO) entitled "Operation and Management, Chesley Landfill Site" and a hydrogeologic study entitled "Hydrogeologic Investigation, Chesley Landfill Site" were prepared by Conestoga-Rovers & Associates Limited (CRA) in 1984. The PDO outlined the operations for the filling and closure of the Phase I which included the western portion of the approved landfill site. The PDO proposed Phase II, a 1.0 ha expansion to the east of Phase I and a hydrogeologic investigation was completed by CRA to support this. The site closed in 2013 under the Closure Plan completed by Genivar on October 25th, 2010. The site continues to be used as a waste transfer and waste diversion site. The landfill site received final cover application and seeding in July of 2013 and a final contour survey was completed November 28, 2013, by WSP, as shown on Figure 2.

2. GENERAL SITE OPERATIONS

As of 2013, the Chesley landfill site has been closed and has not received any additional waste. Reportedly, the entire landfill area was capped in 2013 with final topsoil and seeding being completed in July 2013 in compliance with the Closure Plan (Genivar, 2010). Capping the landfill ensures the waste is unexposed, thus reducing infiltration and the subsequent generation of leachate. The site was approved to receive domestic, commercial and 5 percent other waste limited to scrap metal, brush, wood, construction debris and demolition debris. The site is currently controlled by fencing and is used as a waste transfer and waste diversion depot. Site hours are every 2nd and 4th Saturday of each month from 8am to 12pm. No residential waste is currently accepted by the public at the waste transfer station.

It is noted that before the land use can be changed to something other than waste disposal, the Township will need to submit a land use proposal for approval by the MECP under Section 46 of the *Environmental Protection Act*.

The site is inspected by the Municipality on a regular basis. It is recommended that Site inspections be completed annually in conjunction with the required annual groundwater monitoring program. The Site inspections are to include an inspection of the following:

- (i) potential settlement areas.
- (ii) the final cover and vegetation.
- (iii) site aesthetics.
- (iv) site security (i.e., fencing).
- (v) drainage; and
- (vi) rodent control.

Settlement areas causing surface ponding should be filled and covered with topsoil and vegetation to promote drainage. During the most recent annual monitoring event, no leachate seeps were observed and the ground cover system, site drainage and fencing continued to appear adequate.

2.1 Leachate Management

A leachate collection system intercepts potential leachate seepage along the landfill perimeter and discharges into the Municipal sewage lagoons located on the western adjacent property. Two samples (MH-7 and MH-8) are collected as part of the monitoring program and the Municipality collects monthly samples prior to discharge to the sewage lagoons (refer to section 7 for further discussion).

2.2 Surface Water Management

Ditching along the approved fill area control surface water originating from the landfill site as shown on Figure 2. The ditching directs surface water northerly, discharging into the North Saugeen River. Agricultural fields to the south (upgradient) of the approved fill area are drained via a 600 mm storm sewer that runs east-west discharging into the ditching in the vicinity of the sewage lagoons. Surface water quality is monitored as part of the Monitoring Program and is discussed further in Section 6.

3. SUMMARY OF SITE SETTING

3.1 Site Setting

The Site is surrounded by mixed use properties, including residential, agricultural, and commercial. The topography near the site is undulating and generally slopes towards the west and northwest. The Town of Chesley is supplied Municipal water from two bedrock groundwater wells. The wells are located over a kilometer to the east of the landfill site and the capture zones for the wells extend in an easterly direction away from the landfill.

3.2 Landfill Property

In 2019, based on MECP comment, clarification was requested regarding 2005 Certificate of Prohibition for the Chesley Landfill Site. The limit of the official landfill property was confirmed through review of the Certificate of Prohibition, which described lands included in a 6.4 ha parcel as well as a larger 16.22 ha parcel. Based on a review of the associated reference plans, the lands as described in the Certificate of Prohibition, are consistent with the current ECA, which include an area of 6.4 ha (as shown on Figure 1).

It is of note, that the inferred direction of groundwater flow within the confined overburden is to the west. At this time, the lands located directly to the west are occupied by the Chesley municipal lagoons (i.e., also owned by the Municipality). The municipality has currently initiated the process to include the neighbouring Chesley Lagoon property to included as official Contaminant Attenuation Zone lands. The information has been registered on title and submitted to the MECP director for final processing and approval. As such, it is inferred that the potential for off-site impacts beyond the Landfill and CAZ lands is considered to be negligible.

3.3 Geologic Conditions

The site is situated in the physiographic region known as the Saugeen Clay Plains (Chapman and Putnam, 1984). This region is characterised by fine-textured glaciolacustrine deposits of silt and clay and till moraines with an area of more coarse-textured glaciolacustrine deposits of sand in the southern portion of the region. According to Map 2224 from Chapman & Putnam, the local native soils in the general location of the site consist of fine-textured glaciolacustrine deposits. This is consistent with Report No. 16 of the Bruce County Soil Survey, which defines the native soils on the site as clay loam of the Saugeen series, which is described as a lacustrine with good drainage.

The overburden in the area is approximately 25 to 30 m thick and overlies interbedded grey-brown limestone of the Salina formation (Grey and Bruce Counties, Groundwater Study, 2003). The overburden is reported to be generally consistent as sandy silt and clay with a minor occurrence of coarse-grained sand and gravel unit overlying the bedrock surface.

Review of the available well records, borehole logs and geological cross-sections previously prepared, indicate that the Site is generally underlain by silt and clay till with sand/gravel deposits. Available borehole information and well construction details for the Site and copies of the cross-sections in conjunction with the Hydrogeologic Investigation are provided in Appendix B.

3.4 Hydrogeologic Conditions

3.4.1 Surface Water

The Chesley Landfill is situated in the North Saugeen River watershed. The North Saugeen River is situated northwest of the landfill, adjacent to the Municipally owned westerly property. Surface water is directed to the northwest via drainage ditches that ultimately outlet to the North Saugeen River. Surface water is monitored at seven locations as shown on Figure 2.

3.4.2 Groundwater

The groundwater monitoring program began in 1984 and includes wells installed in 1981, 1982 and 1983 under the direction of CRA. Based on the available information provided, shallow wells TH1-82, TH6-81, TH7-81, and TH8-81 were installed in dug pits using PVC standpipes and native backfill. The wells are reportedly installed to depths ranging from 2.3 meters below ground surface (mbgs) to 3.5 mbgs and were terminated in relatively low permeability clay silt till. Monitoring wells TH2-81 and TH-4-81 were replaced in 2002 and were reportedly installed in the same proximal location but were advanced 1.5 m deeper than the original wells. TH1-82 and TH2-02 were replaced prior to the fall sampling event in 2019 with wells OW5-18 and OW6-19. The wells were installed in the same proximal location but were advanced deeper to a depth of 6.09 mbgs and 4.57 mbgs, respectively. All available Borehole logs are provided within Appendix B.

Based on the information available, the majority of the wells are screened in the shallow overburden clay silt till soils with some sand lenses being present. The screened intervals for the shallow overburden wells located in the vicinity of the licensed landfill area, including TH1-82/OW5-19, TH6-81, TH7-81, TH8-81, TH2-02/OW6-19 and TH4-02. The Hydrogeologic Investigation indicates that the clay till acts as a barrier and that a deeper confined overburden aquifer exists. In previous reports this has been monitored by wells OW1-83, OW2-83, OW3-83, and OW4-83. Based on the groundwater elevations and groundwater chemistry observed, the system has limited vertical flow and connection.

An upward vertical gradient was observed by comparing groundwater elevations from the wells OW1-83, OW2-83, and TH1-83/OW5-19 which are all situated in close proximity to each other along the northern property boundary of the approved landfill site. Horizontal gradients are typically 0.001 to 0.008 m/m on the site.

Water levels are measured in all available wells during each sampling event. The measured water levels are then used to determine the direction of groundwater flow at the landfill site. The historic water level elevations, including the most recent data, are provided in Appendix C and a groundwater contour plan is provided as Figures 3 and 4. Based on historical results, groundwater flow within the shallow overburden is generally to the northwest toward the North Saugeen River.

Based on the hydrogeologic conditions and site setting in close proximity to the North Saugeen River, the shallow overburden is the most likely receiver of leachate impacts with horizontal flow towards the river. Downward migration of leachate influenced groundwater is not expected due to the local upward gradients, proximity to the river where groundwater is inferred to discharge, and the relatively low permeability soils.

4. RECYCLING/WASTE REDUCTION

The Municipality of Arran-Elderslie conducts a recycling and waste diversion program at the Arran landfill site. It is noted that the Municipality provides an additional drop-off location for tires and scrap metal at the closed Chesley Landfill Site. However, based on the Chesley Landfill being closed and capped to date, no additional recycling or waste diversion is currently completed at the landfill site.

Continued attention should be given to the management of the tire piles located at the Arran and Chesley landfill facilities. The size of the tire pile should be monitored on a regular basis to ensure that there are fewer than 5,000 tire units onsite at any given time as per the requirements of the Environmental Protection Act (EPA). Furthermore, it is important that the Municipality continue to remove stockpiles of used tires and accumulations of other salvageable materials on a regular basis to prevent clutter and to maintain an aesthetically acceptable site.

Based on the existing CofA, burning of segregated, clean wood (i.e., untreated lumber) and brush is permitted and is to be conducted in accordance with “MECP Guideline C-7, Burning at Landfill Sites (April 1994)”. A copy of this Guideline is provided in Appendix D. Burning of waste is prohibited. Any brush, trees and clean wood material should be stockpiled separately, in a pile generally no larger than 6 by 6 m in area and 3 m in height. Supervised burning of wood waste is to occur on clear, dry, windless days when the Site is closed to the public. The Site attendant and/or operator is responsible for removing any non-wood wastes from the pile prior to burning and should regularly remove cold ashes from the burn area for disposal in the active landfill area.

5. WATER QUALITY MONITORING

5.1 Groundwater Monitoring Program

Groundwater monitoring at the Chesley landfill was implemented in 1984 to evaluate the impacts landfill leachate may have on the groundwater resources in the vicinity of the Site. Although the sampling requirements, including the locations and parameters, have been revised several times, according to the CofA the monitoring program was to be conducted twice annually in the spring and fall.

Groundwater at the Chesley Landfill Site is currently monitored by a system of 10 monitoring wells installed throughout the landfill site as shown on Figure 2. The established monitoring program within the CofA is outlined as follows:

Wells to be Sampled Twice Annually in the Spring and Fall	Parameters
OW1-83 TH4-02 OW2-83 TH6-81 OW3-83 TH7-81 OW4-83 TH8-81 OW5-19 OW6-19	Chloride, sulphate, pH, phenols, nitrite, nitrate, TKN, total phosphorous, hardness, conductivity, ammonia, alkalinity, and metals (Ca, Mg, Na, K, As, and Fe)

The sampling events in 2023 were conducted on April 11th and November 2nd. Based on MECP correspondence, during the fall sampling event, TH6-81, TH7-81 and TH4-04 were removed from the sampling program. Summaries of the historical groundwater analytical results and long-term trend analysis graphs are provided in Appendix E.

5.2 Surface Water Monitoring Program

Ditching along the approved fill area control non-contact surface water (i.e., stormwater) originating from the landfill site as shown on Figure 2. The ditching directs surface water northerly, discharging into the North Saugeen River. Agricultural fields to the south (upgradient) of the approved fill area are drained via a 600 mm storm sewer that runs east-west discharging into the ditching in the vicinity of the sewage lagoons.

Surface water quality is monitored as part of the Monitoring Program at seven locations. Over 30 years of surface water monitoring results completed between 1981 to the present did not indicate any landfill related impacts to the North Saugeen River. In order to satisfy the requirements of the CofA for the Site, surface water samples are collected from the following locations, where shown on Figure 2:

Surface Water to be Sampled Twice Annually in the Spring and Fall	Parameters
SP2-85 SP2A-85 SP3-85 SP4-85 SP5-88 SS1-99 SP1-83	pH, conductivity, hardness, alkalinity, phenols, TKN, total phosphorous, dissolved organic carbon (DOC), chloride, sulphate, nitrite, nitrate, ammonia, and metals (i.e., Ca, Mg, K, As, Fe and Na).

5.3 Leachate Monitoring Program

The Landfill is equipped with a leachate collection system established in 1986. The system is equipped with a series of manholes that are located along the perimeter of the landfill footprint. Samples are collected from two manholes (MH-7A and MH-8). The sample locations are to the south of the landfill footprint, as historically no water has been observed within the manholes to the north. In 2011, at the request of the MECP, a leachate characterization well (LW1-11) was installed to a depth in which it intercepts native soils and is within the landfill footprint. The leachate monitoring program is as outlined:

Leachate Collection to be Sampled Twice Annually in the Spring and Fall	Parameters
LW1-11 MH-7A MH-8	pH, conductivity, hardness, chloride, phenols, ammonia, alkalinity, nitrite, nitrate, TKN, total phosphorous, BOD, DOC, COD, and metals (i.e., Ca, Mg, K, As, Fe and Na).

5.4 Sampling Procedures

For the groundwater and leachate manhole sampling, the static groundwater level and well depth are measured in each monitoring well prior to purging three casing volumes of stagnant water from each monitoring well. GMBP personnel also check to ensure that all monitoring wells are properly secured and in compliance with O.Reg. 903. After purging, monitoring wells are allowed to recharge with fresh groundwater before sampling occurs. Groundwater purging and sampling is conducted using dedicated Waterra™ tubing and inertial-type pumps. Samples are collected in laboratory supplied containers and are kept chilled following completion of the sampling program and sent within 24 hours of the sampling event to Caduceon Environmental Laboratories in Barrie, Ontario for analysis. Samples collected for metals are placed in laboratory supplied containers without preservative and are filtered and preserved by Caduceon prior to analysis. The laboratory analytical report for the current monitoring year is included in Appendix E.

Surface water samples are collected by submerging the appropriate sample container into the water body and removing the container when a sufficient volume of sample has been collected. During collection, contact with the bottom sediment is avoided to prevent stirring-up sediment. When collecting surface water samples, direct dipping of the sample bottle is acceptable unless the bottle contains preservative.

For those samples requiring preservative, a clean unpreserved bottle is used to obtain the sample, which is then transferred into the appropriate preserved bottle. Surface water samples collected for total metals are placed in laboratory supplied containers with preservative and are not filtered prior to analysis. The surface water temperature is measured and recorded at the time of sampling.

6. DETERMINATION OF REASONABLE USE CRITERIA FOR THE SITE

6.1 Determination of Action Levels

MOE Guideline B-7 establishes the basis for determining what constitutes the reasonable use of groundwater on properties adjacent to landfill sites. By applying the Reasonable Use Concept, the potential use of groundwater for domestic consumption will almost always provide the lowest allowable concentration limits. MOE Procedure B-7-1 provides technical details for the application of the reasonable use approach. A change in the quality of groundwater on an adjacent property, where the reasonable use is determined to be for drinking water, will be acceptable only where:

- i) Quality is not degraded by more than 50% of the difference between background concentrations and the Ontario Drinking Water Standards (ODWS) for non-health related parameters, and
- ii) Quality is not degraded by more than 25% of the difference between background concentrations and the ODWS for health-related parameters.

Background concentrations are considered to be the quality of the groundwater prior to any contamination from landfill activities.

6.2 Background Groundwater Quality

Background concentrations are considered to be the quality of the groundwater prior to any impact from landfill activities. Historically, monitoring well TH1-81 was used as the background monitoring well location to represent the shallow groundwater conditions and OW4-83 was used to represent the deeper groundwater system. Both wells were located northeast of the landfill footprint. TH1-81 was only sampled for two sampling events before it was damaged and decommissioned in 1982. Based on the review completed for this report, we are no longer using TH1-81 to represent background conditions based on the limited data points and since there is evidence of temporal changes to shallow groundwater due to anthropogenic sources (i.e., the background shallow water quality appears to have been influenced by road salting over the last 40 years).

Based on the temporal changes in groundwater quality, the background water quality has been updated in this report. OW4-83 has been selected to be the background monitoring location based on the direction of shallow groundwater flow at the Site and its location relative to the fill area, which results in the least potential for impacts from the landfill. It is located to the northeast of the approved fill area. In particular, shallow groundwater is starting to exhibit influence from road salting and agricultural activities upgradient of the landfill.

Historical and current quality results support the use of OW4-83 as a background well as the results indicate that this monitoring location typically has the lowest concentrations of indicator parameters. Historical results from OW4-83 from 1983 to present, provided in Appendix D, were used to calculate average values of indicator parameters for the subsequent calculation of the RUC values. The background concentration ranges, averages, and resulting RUC values for several indicator parameters are summarized on Table 1.

The background water quality is typical of a carbonate system and is generally highly mineralized with an average background hardness of 305 mg/L. In general, the background chloride concentrations are typically less than 20 mg/L, and the background specific conductance (i.e., conductivity at 25° Celsius) is, on average, approximately 602 uS/cm.

It is noted that the hardness typically exceeds the RUC at all monitored locations. Therefore, the elevated hardness concentrations alone do not appear to be related to impacts from landfill leachate and can be attributed to the natural background conditions.

6.3 Calculation of Objective Levels

The objective levels for several groundwater quality indicator parameters were calculated to evaluate the acceptable level of contaminant concentrations at the Site boundary. Background concentrations (Cb) are the site-specific values (discussed in the previous section). The Provincial maximum concentrations (Cr) are identified in the Ontario Drinking Water Standards. Acceptable concentrations at the site boundary (Cm) are calculated from MOECC Procedure B-7-1 using the following formula:

$$C_m = C_b + x(C_r - C_b)$$

Where:

Cm = Maximum concentration acceptable in groundwater beneath an adjacent property.

Cb = Background concentration.

Cr = Maximum concentration that should be present in groundwater for domestic consumption according to the ODWS.

x = 0.5 for non-health related parameters (AO and OG) and 0.25 for health-related parameters (MAC and IMAC).

AO = Aesthetic Objective

OG = Operational Guideline

MAC = Maximum Acceptable Concentration, Parameters Related to Health

IMAC = Interim Maximum Acceptable Concentration, Parameters Related to Health

It should be noted that if background concentrations exceed the ODWS, the objective level is set at the background concentration. A summary of the average background concentrations and resulting RUC values are provided in Table 1 and a summary of the current monitoring period analytical results compared to the RUC and ODWS is provided in Table 2.

To determine if leachate is impacting groundwater, individual indicator parameters were evaluated in conjunction with other indicator parameters and concentration trends. Monitoring wells with elevated and stable concentrations of the identified naturally elevated constituents, which show no increases in other leachate indicator parameters, are deemed un-impacted by landfill leachate. Additionally, comparison of known leachate impacted groundwater is compared to the groundwater chemistry at locations with naturally elevated concentrations to determine if leachate contributes to the elevated concentrations measured.

6.4 Provincial Water Quality Objectives (Surface Water)

The purpose of surface water quality management at the Site is to achieve the requirements established in the Provincial Water Quality Objectives (PWQO) set out by the MECP. The PWQO for the required list of analytical parameters is provided in Table 6. The PWQO were established to ensure that surface waters are of a quality, which is satisfactory for aquatic life and recreation. Areas that have water quality surpassing the PWQO requirements are to be maintained at or above the applicable objectives. Areas that have water quality that does not presently meet the PWQO are not to be degraded any further and are to be upgraded if practical.

7. MONITORING RESULTS AND DISCUSSION

Leachate is produced when surface water percolates down through refuse resulting in impacted water that has the potential to migrate along the surface or in the ground. Landfill derived leachate that enters into the surface water and/or groundwater is often attenuated by natural mechanisms along the water migration pathway. The attenuation of leachate can occur by dilution, biologic activity, and geochemical mechanisms. To determine the presence of (or potential impacts from) leachate, several indicator parameters are monitored, and a trend analysis is conducted to determine changes in water quality over time.

At the Chesley Waste Disposal Site, it is anticipated that leachate production will be reduced in comparison to the leachate produced prior to site closure in 2013. The cover material acts to limit the volume of surface water percolating down through the refuse, thereby limiting leachate production through surface water percolation.

Additionally, review of the available cross-sections and borehole logs suggests that the waste was likely placed above the water table. Therefore, the production of leachate by the migration of groundwater through the bottom of the refuse pile is unlikely. A leachate characterization well LW1/11 was installed by Genivar (now WSP). Based on the borehole log provided with Appendix B, the leachate well was screened across the waste and native soil. The historical groundwater elevations indicate that the groundwater is typically below the waste, indicating a limited interaction between waste and groundwater.

The following sections discuss the potential impacts to groundwater and surface water on-site and leaving the property boundaries in reference to compliance with the RUC. The groundwater quality results for the current monitoring year are summarized in Tables 2 and 3. Historical groundwater sampling results and graphical trends of indicator parameters are included in Appendices E and F.

It should be noted that consistent with groundwater flowing through carbonate-rich soils, hardness concentrations consistently exceed the ODWS operational guidelines. Therefore, references to hardness exceedances are only made where the concentrations are significantly higher than those measured in the background well.

7.1 Leachate Monitoring

The Landfill is equipped with a leachate collection system established in 1986. The system is equipped with a series of manholes that are located along the perimeter of the landfill footprint. Samples are collected from two manholes (MH-7A and MH-8). The sample locations are to the south of the landfill footprint, as historically no water has been observed within the manholes to the north. The Municipality also collects monthly samples from the outlet of the leachate collection system prior to it discharging into the sewage lagoon (refer to Appendix G).

During the spring and fall monitoring events, samples were collected from the leachate collection system at manhole MH-8 and MH-7 and the analytical results are summarized on Table 4. The analytical results report minor elevation in concentrations of nitrate, conductivity and hardness when compared to background concentrations. It should be noted that samples collected from the manholes are unlikely to represent the actual leachate strength within the closed landfill as the system is subject to dilution through an upgradient spring. Historically (prior to 2001), elevated concentrations of leachate indicator parameters including chloride, conductivity, BOD, COD, and phenols were reported.

In 2011, at the request of the MECF, a leachate characterization well (LW1-11) was installed to a depth in which it intercepts native soils and is within the landfill footprint. The water level is typically less than 0.5 m above the waste, indicating a limited interaction between the waste and groundwater. This is also observed in the lack of groundwater present within the leachate collection system. During the 2023 monitoring period LW1/11 was

sampled during the spring and fall. The leachate impacts below the landfill footprint appear to be limited, and most leachate indicator parameters are reported to be within background concentrations. The analytical results indicate elevated concentrations of conductivity, DOC, and hardness, but are within historical concentrations and only exceed the ODWS and the RUC for hardness and DOC.

7.2 Groundwater Quality

7.2.1 Shallow Overburden

Groundwater quality in the vicinity of the approved fill area is measured in the shallow overburden aquifer at wells TH1-82/OW5-19, TH2-02/OW6-19, TH4-02, TH6-81, TH7-81, and TH8-81 were shown on Figure 2. These wells are screened within the silt and clay till unit approximately three to six meters below ground surface (mbgs). The current monitoring period groundwater quality is summarized on Table 2 and the historical data including trends are presented within Appendix E.

Upgradient/Cross gradient of Landfill Footprint

Test well TH2-02 was decommissioned and replaced on July 23rd, 2019, with OW6-19 as per previous consultation with the MECP. OW6-19 is located to the southeast of the landfill footprint and monitors the groundwater quality upgradient of the fill area. Similar to historical groundwater quality, the reported concentrations for hardness and alkalinity exceeded the ODWS and the RUC but were within the range of background concentrations. The chloride concentrations (35 mg/L and 27 mg/L in the spring and fall, respectively), while below the ODWS and the RUC, was elevated when compared to background concentrations, but is consistent with historical chloride concentrations at this location. TH2-02/OW6-19 is in close proximity of an access road for the on-site waste diversion area. The chloride concentration may be elevated due to road salting activities. Concentrations of other indicator parameters not typically influenced by road salting activities have consistently been similar to background conditions. OW6-19 was installed to a depth of 6.09 m bgs, approximately two and a half meters deeper than TH2-02.

TH4-02 is located to the southwest of the landfill footprint and monitors the cross gradient groundwater quality. TH4-02 was reported to have elevated hardness concentrations during the spring sampling period but was noted to be within the historical concentration range at this location. Concentrations of indicator parameters have historically shown a stable trend. Based on MECP correspondence dated September 28, 2023, and an additional meeting completed on October 26, 2023, TH4-02 was removed from the monitoring program due to the improper installation techniques.

Downgradient of Landfill Footprint

Monitoring well TH1-82 was decommissioned and replaced by OW5-19 on July 23rd, 2019. TH1-82/OW5-19 is in proximity to the north property boundary of the licenced landfill property and north of the landfill footprint. It should be noted that the Municipality owns additional lands to the north and west of the landfill property (as shown on Figure 2). The additional lands are used as a water treatment plant and consist of sewage lagoons and the associated building and have similar stringent land use restrictions as the landfill site.

OW5-19 was installed to an approximate depth of 4.57 m, approximately 1 m lower than TH1-82. The spring and fall monitoring program reported elevated concentrations of hardness, however the elevated concentrations were within background concentrations and are not inferred to be indicative of leachate impacts. Based on the current and historic reported concentrations of indicator parameters, there is no evidence of leachate impacted groundwater at this location.

TH6-81 is located to the northwest, approximately 10 m of the landfill footprint and approximately 35 m south of the north property boundary of the approved landfill site. During the spring monitoring event, elevated concentrations of alkalinity, conductivity, and hardness were reported at TH6-81. The reported elevated concentrations are within the historical ranges observed at this location and indicator parameters have generally been stable at TH6-81 for the past ten years. TH7-81 is located to the northeast, approximately 10 m of the landfill footprint and approximately 35 m south of the north property boundary of the approved landfill site. During the spring monitoring event, elevated

concentrations of hardness were reported but noted to be within the background concentrations. TH7-81 was installed within an excavation at an approximate depth of 3.5 m bgs. Thus, highly variable groundwater concentrations can be expected as the shallow groundwater is likely to be influenced by surface water events such as freshets (snowmelts) and heavy rainfalls. Based on MECP correspondence and the un-reliability of data collected at the former test hole monitoring locations, TH6-81 and TH7-81 was removed from the monitoring program and were not sampled during the fall sampling period. It is noted that the shallow groundwater is tested further north (downgradient) at TH8-81.

TH8-81 is located north of the landfill property approximately 20 m south of the northern boundary of the municipally owned property. The groundwater at TH8-81 is inferred to be representative of the groundwater leaving the site downgradient of the landfill footprint. Elevated concentrations of hardness were reported during the monitoring year. The elevated concentrations were within observed background concentrations, and other indicator parameters such as chloride concentrations remain similar to background conditions. The historical concentrations at TH8-81 show a stable trend. Based on the current and historic reported concentrations of indicator parameters, there is no evidence of leachate impacted groundwater at this location. It is noted that elevated nutrient concentrations (nitrite and ammonia) have been noted at this location and are inferred to be associated with the agricultural land use directly north of TH8-81. Additional monitoring is recommended to discern if an elevated trend becomes apparent.

7.2.2 Deep Overburden

Groundwater quality in the deeper overburden aquifer is monitored at wells OW1-83, OW2-83, OW3-83, and OW4-83. Well, OW1-83 and OW2-83 are located directly downgradient of the fill area in the vicinity of the shallow monitoring well OW5-19. Well, OW3-83 is located to the south, upgradient of the landfill footprint and OW4-83 is located to the northeast of the landfill site. OW4-83 was installed to replace TH1-81 which was used as the background well. OW4-83 is in close proximity to the access road. Groundwater elevations reported for these deeper overburden monitoring locations compared to nearby shallow overburden wells indicate that an upward gradient exists in the vicinity of the landfill.

Upgradient/Cross gradient of Landfill Footprint

OW4-83 is located to the northeast of the landfill footprint and is inferred to be cross gradient of the landfill footprint. Elevated concentrations of chloride, conductivity, and hardness were reported for both the spring and fall sampling events. Hardness concentrations are within measured historical and background concentrations.

Chloride and conductivity concentrations have generally been showing an increasing trend, however, have begun to decrease in the most recent sampling events (i.e., since fall 2020). OW4-83 is in close proximity of an access road for the on-site waste diversion area. The chloride and conductivity concentrations may be elevated due to road salting activities. Concentrations of other indicator parameters that are not typically influenced by road salting activities have consistently been similar to background conditions. Based on correspondence with the Municipality, snow removed from the municipal roadways in town is stored directly east of OW4-83, along the landfill access road. It is recommended that OW4-83 continue to be analysed for sodium to further assess the road salting activities.

OW3-83 is located to the south of the landfill footprint and is inferred to be hydraulically cross gradient. Elevated concentrations of hardness were reported during the spring and fall monitoring event. The elevated concentrations were all within measured historical and background concentrations.

Downgradient of the Landfill Footprint

OW1-83 and OW2-83 are located north of the landfill, in proximity to OW5-19. Based on the borehole information provided (Appendix B), both wells are screened within silty sand. OW2-83 is reported to be terminated at a depth of 6.25 m bgs and OW1-83 is reported to be terminated at a of 12.34 m bgs. It should be noted that the Municipality owns additional lands to the north and west of the landfill property (as shown on Figure 1). The additional lands are used as a water treatment plant and consist of sewage lagoons and the associated building.

During the current spring and fall monitoring events, the reported leachate indicator parameters at monitoring well

OW2-83 were reported to be within the measured historical and background concentrations. The historical concentrations at OW2-83 show a stable trend. Based on the current and historic reported concentrations of indicator parameters, there is no evidence of leachate impacted groundwater at this location.

OW1-83 has historically shown minor leachate influence. During the current spring monitoring period the concentrations of indicator parameters were reported to be within the measured historical and background concentrations. In the spring and fall, elevated chloride concentrations were noted when compared to background concentrations. However, it should be noted that the chloride concentrations are lower than both the ODWS and the RUC at this location. Other indicator parameters such as alkalinity, conductivity, hardness, and sulphate were reported to be similar to background concentrations and generally show a stable to decreasing trend over time.

The indicator parameter concentrations at OW1-83 have historically shown minor impact from landfill leachate, especially in the fall, due to the close proximity to the landfill footprint. Based on correspondence with the Municipality, snow removed from the municipal roadways in town is stored directly east of OW1-83, along the landfill access road. Based on the groundwater flow direction, and the adjacent drainage channels, it is inferred that the elevated chloride trends are related to the snow storage onsite. Typical with influence from road salt application, the ratio of chloride to sodium observed at OW1-83 is typically in the range of 2:1 or greater. In contrast, wells showing influence from leachate typically have a ratio of chloride to sodium in the range of closer to 1:1. The chloride concentrations combined with the elevated sodium levels indicate influence that is most likely from road salt rather than leachate influence.

It should be noted that the Municipality owns additional lands to the north and west which are used as a water treatment plant with sewage lagoons. Additionally, the shallow groundwater is tested further north (downgradient) at TH8-81, where reported concentrations are similar to background levels. Furthermore, based on MECP recommendation, it is noted that the Municipality is currently in the process of converting the additional lands to the north and west to be formally recognized as Contaminant Attenuation Zone (CAZ) on the ECA.

7.3 Surface Water

Ditching along the approved fill area control surface water originating from the landfill site as shown on Figure 2. The ditching directs surface water northerly, discharging into the North Saugeen River. Agricultural fields to the south (upgradient) of the approved fill area are drained via a 600 mm storm sewer that runs east-west discharging into the ditching in the vicinity of the sewage lagoons.

Surface water quality is monitored as part of the Monitoring Program at seven locations and is summarized within Table 3. SP1-83, SP2-85, SP2A-85, SP5-88, and SS1-99 are collected from various locations within the north drainage channel. SP3-85 is collected from upstream of the North Saugeen River and SP4-85 is collected from downstream of the North Saugeen River. A summary of the surface water quality reported during the current monitoring year is presented in Table 3. Historical water quality including indicator parameter trends can be found in Appendix F.

SP1-83 is located along the northern property boundary at a shallow groundwater discharge point. A clay tile was reportedly installed during the construction of the sewage lagoons to relieve groundwater pressure and divert flow away from the lagoon excavation area. Historically minor leachate influence was observed at this location. Since the landfill closed in 2013, the concentrations of indicator parameters have shown a decreasing trend. A sample was collected during the spring monitoring event in 2023, and no RUC exceedances were reported.

SP2-83 is located to the north of the landfill within the drainage channel that collects water from the eastern portion of the site. Based on the 2023 spring and fall monitoring periods, no exceedances of the RUC were reported, and indicator parameter trends at this location are observed to be stable.

SP2A-85 is located upstream of the access road of the drainage channel, north of the landfill near the eastern property boundary. It is upstream of SP2-85. Water quality from SP2A-85 is considered to represent background surface water quality for the site.

SP5-88 is located north of the landfill property at a point where the drainage channels from the landfill converge. Historically, water quality at this location has shown minor landfill impacts. Indicator parameter trends at this location appear to be relatively stable, with exception to chloride which has historically shown an increasing trend. It is noted that SP5-88 is located directly adjacent to the access road drainage channel, where snow storage is located throughout the winter months. It is inferred that the elevated chloride trend may be attributed to the location of the snow storage.

SS1-99 is located to the west of the landfill within a separate drainage channel. Historically no leachate impacts were reported at this location and the trends are stable. In 2023, indicator parameters remain similar to background conditions. Due to the agricultural nature of adjacent lands which also utilize the ditch, it is not unreasonable to expect elevated nutrients from the agricultural fields within the surface water at this location.

SP3-85 and SP4-85 are located within the North Saugeen River, upstream and downstream, respectively, of the surface water drainage outlet north of the landfill site. Impacts to the North Saugeen River are evaluated by comparing surface water samples from upstream (i.e., SP3-85) to the sample from downstream (i.e., SP4-85).

Historically, indicator parameters have remained low and the trends of indicator parameters within the North Saugeen River are stable. In 2023, no exceedances of the PWQO were reported at either upstream or downstream sampling locations. Based on the reported analytical data, the water quality is similar between the upstream and downstream locations and no leachate impacts to the water quality are evident in the North Saugeen River.

7.4 Water Quality Summary

Leachate is monitored via samples collected from manholes located to the south of the landfill site as well as a leachate characterization well LW1/11. During the current monitoring period, the analytical results report minor elevation in concentrations of chloride, conductivity and hardness when compared to background concentrations. Historically (prior to 2001), elevated concentrations of leachate indicator parameters including chloride, conductivity, BOD, COD, and phenols were reported.

Consistent with historical results, groundwater flow within the shallow overburden is generally to the northwest toward the North Saugeen River. The groundwater is monitored along the northwest by wells TH1-82/OW5-19, OW1-83, OW2-83, and TH8-81. Although landfill leachate-impacted groundwater has historically been noted at the Site, recent groundwater monitoring results indicate that impacts related to landfill leachate are minor and are only observed near the approved landfill footprint. Groundwater monitored further downgradient at TH8-81, reported concentrations similar to background levels. Based on the analytical results, there does not appear to be groundwater exceedances of the RUC across the northern boundary and the groundwater quality is generally similar to background conditions.

Elevated chloride concentrations were observed in sampling locations in close proximity to the access road, where snow storage is located during the winter months. It is recommended that sodium and alkalinity continue to be monitored to further assess the road salting activities.

Upwards hydraulic gradients have been observed in the vicinity of the fill area. Groundwater quality in the deeper overburden is monitored at wells OW1-83 and OW2-83, which is immediately downgradient of the landfill, and at OW3-83 and OW4-83, located directly upgradient and cross gradient of the landfill. Historically, some elevated leachate indicator parameters have been noted at the downgradient locations as part of previous annual reports. Based on this review, it appears the slightly elevated parameters are likely associated with natural differences in groundwater quality between the shallow and deep systems.

Based on the well depth at OW1-83 (12.3 mbgs), the overburden thickness of 30 m, the relatively minor leachate influence, and the additional lands owned by the Municipality, the migration of leachate-influenced groundwater into the underlying bedrock unit and/or to the beyond the Municipally owned property is not anticipated.

Based on the limited size of the landfill and since the landfill was closed in 2013, it is reasonable to expect that groundwater and surface water quality will improve over time. Based on the relatively limited potential for continued impacts to groundwater quality directly beneath the landfill, the potential for future off-site impacts is considered to be very low, particularly since the groundwater quality at the “boundary” monitoring wells continues to show no impacts related to the landfill.

8. 10-YEAR POST-CLOSURE MONITORING REVIEW

In light of the closure of the landfill since 2013 and the groundwater and surface water monitoring data, a review was previously to assess the efficacy of the current program and to optimize it based on the decades of results and known conditions associated with the site.

Based on the assessment provided in Section 7 of the report, the following risk-based considerations are provided:

- The landfill has been closed for 11 years and no changes to the landfill mound have been completed and no additional waste has been placed,
- The monitoring network includes a leachate monitoring well and monitoring wells close to the landfill footprint that show stable to decreasing trends,
- The extended monitoring network shows stable to decreasing trends of leachate indicator parameters with no impacts above the RUC,
- No significant concentrations or concerns with VOCs have been detected at key monitoring locations,
- There is no reason to expect an increase in groundwater concentrations or parameters (i.e., after 10 years, it is reasonable to expect that the groundwater plume has reached a stasis and that no “undetected” impacts will form a new issue). This is exhibited by the leachate well and wells close to the landfill footprint.
- There is no significant seasonable variability in concentration or groundwater direction between spring and fall sampling,
- The lands “downgradient” of the site are owned by the municipality. Additionally, the Municipality is in the works of converting the downgradient lands to CAZ lands.

Following the most recent MECP correspondence and discussions, some uncertainties remain regarding the compliance along the northerly property boundary. In particular, uncertainty regarding the potential for influence was raised based on the elevated sodium and chloride parameters being observed. The addition of monitoring parameters was recommended as a potential solution to confirming the relation of sodium and chloride to the landfill leachate.

A more detailed review of site conditions was completed with the following relevant observations:

- snow removed from the municipal roadways in town is stored directly east of OW1-83, along the landfill access road (unknown at the time of the MECP review).
- Based on the groundwater flow direction, and the adjacent drainage channels, it is inferred that the groundwater and surface water would flow from the snow storage area towards OW1-83.
- The timing of the rise in salt related parameters relatively close to the landfill is long after closure and more consistent with the more recent timing of the snow storage activities.
- The ratio of chloride to sodium observed at OW1-83 is typically in the range of 2:1 or greater, which in our experience is consistent with road salting operations as opposed to landfill leachate.
- There is an absence of other leachate indicator parameters at any appreciable concentration and these indicator parameters are not showing a concurrent (or retarded) increasing trend in correlation with the sodium and chloride. i.e., there only appears to be an increasing trend of the salt related parameters.

Based on our experience with over 30 rural landfills, it is not probable to have leachate from a landfill only be influenced by sodium and chloride over time (recognizing the conservative nature of chloride and the potential for the leading edge of a plume).

Regardless of the discussion above and to address MECP comments regarding OW1-83, GMBP has recommended the below enhanced parameter list. Recognizing that the primary reason for the monitoring program is to assess compliance with RUC and detect the potential for impacts to human health or the environment we recommended the following new monitoring program:

Locations to be Sampled Once Annually in the Spring	Parameters
Monitoring Wells	
OW1-83 TH4-02 OW2-83 TH6-81 OW3-83 TH7-81 OW4-83 TH8-81 OW5-19 OW6-19	Chloride, sulphate, pH, phenols, nitrite, nitrate, TKN, total phosphorous, hardness, conductivity, ammonia, alkalinity, DOC, BOD, COD, and Al, Sb, As, Ba, B, Be, Ca, Cd, Co, Cr, Cu, Fe, Pb, Mg, Mn, Mo, Ni, K, Se, Ag, Si, Na, Sr, Ti, Tl, U, V, Zn.
Surface Water	Parameters
SP2-85 SP2A-85 SS1-99 SP3-85 SP4-85 SP5-88	pH, conductivity, hardness, alkalinity, phenols, TKN, total phosphorous, dissolved organic carbon (DOC), chloride, sulphate, nitrite, nitrate, ammonia, and metals (i.e., Ca, Mg, K, As, Fe and Na).
Leachate Collection and Monitoring Well	Parameters
LW1-11 MH-7A MH-8	pH, conductivity, hardness, chloride, phenols, ammonia, alkalinity, nitrite, nitrate, TKN, total phosphorous, BOD, DOC, COD, and metals (i.e., Ca, Mg, K, As, Fe and Na).

Based on MECP consultation, the extra monitoring framework is recommended for a period of one year, at which time it is anticipated that there would be more certainty regarding the influence of leachate at OW1-83, and that the monitoring program can be reviewed with the context of long-term closure of the landfill and optimization of the monitoring program. It is recognized that the continuing monitoring program must continue until approval of the changes by the MECP. Based on Condition 49. c) of the ECA, the monitoring program may be amended by the District Manager.

Efforts will also be made during spring sampling to determine if an additional downgradient compliance monitoring well may be feasible within the north-westerly portion of the property.

9. CONCLUSIONS

1. The Chesley Landfill Site is described as Part of Lot 5, Registered Plan 236, Part of Lot 28, Concession 2 Parts of King and Spring Streets and Part of Lot 28, Concession 1, Municipality of Arran-Elderslie (former Town of Chesley). The landfill is operated in compliance with CofA No. A272402, as amended. As of 2013, the Chesley landfill site, which was approved to receive domestic, commercial and 5 percent other waste limited to scrap metal, brush, wood, construction debris and demolition debris has been closed and has not received any additional refuse.
2. At this time, the lands located directly to the west are occupied by the Chesley municipal lagoons (i.e., also owned by the Municipality). In 2023, the municipality initiated the process to include the neighbouring Chesley Lagoon property to included as official Contaminant Attenuation Zone lands. The information has

been registered on title and submitted to the MECP director for final processing and approval. As such, it is inferred that the potential for off-site impacts beyond the Landfill and CAZ lands is considered to be negligible.

3. In 2023, no leachate seeps were observed and the ground cover system, site drainage and fencing continued to appear adequate.
4. The groundwater flow within the shallow overburden is generally to the north, northwest. An upward gradient into the underlying silty clay unit likely exists in the vicinity of the existing fill area.
5. A leachate collection system intercepts potential leachate seepage along the landfill perimeter and discharges into the Municipal sewage lagoons located on the western adjacent property. Two samples (MH-7 and MH-8) are collected as part of the monitoring program and the Municipality collects monthly samples prior to discharge to the sewage lagoon.
6. The analytical results of the leachate report minor elevation in concentrations of chloride, conductivity and hardness when compared to background concentrations. Historically (prior to 2001), elevated concentrations of leachate indicator parameters including chloride, conductivity, BOD, COD, and phenols were reported.
7. Ditching along the approved fill area control surface water originating from the landfill site. The ditching directs surface water northerly, discharging into the North Saugeen River. Agricultural fields to the south (upgradient) of the approved fill area are drained via a 600 mm storm sewer that runs east-west discharging into the ditching in the vicinity of the sewage lagoons. Surface water quality is monitored as part of the Monitoring Program at seven locations.
8. The surface water quality within the drainage channel for the 2023 monitoring period reported no exceedances of the RUC. Surface water quality in the North Saugeen River in the vicinity of the outlet for the drainage channel remain similar between the upstream and downstream locations and no leachate impacts to the water quality are evident in the North Saugeen River.
9. Although landfill leachate-impacted groundwater has historically been noted at the Site, recent groundwater monitoring results indicate that impacts related to landfill leachate are minor and are only observed near the approved landfill footprint (TH6-81 and TH7-81). Groundwater is monitored further downgradient at TH8-81. Based on the analytical results, the site is in compliance with the MOE Guideline B-7 criteria and there does not appear to be groundwater exceedances of the RUC across the northern boundary and the groundwater quality is generally similar to background conditions. The additional CAZ lands to the northwest provide certainty regarding compliance with the RUC.
10. Based on the limited size and filling rate of the landfill, the site closure in 2013, it is reasonable to expect that the water quality will remain stable or will improve over time. Based on the relatively limited potential impacts to groundwater quality directly beneath the landfill, the potential for future off-site impacts is considered to be low. The proposed supplemental program is expected to confirm water quality conditions across the site and the differentiate the potential influence from salt versus leachate.

10. RECOMMENDATIONS

1. It is recommended that annual visual inspections of the premises and monitoring wells continue to be conducted annually in conjunction with the groundwater monitoring program.
2. Following the most recent MECP correspondence and discussions, some uncertainties remain regarding the compliance along the northerly property boundary. Recognizing that the primary reason for the monitoring program is to assess compliance with RUC and detect the potential for impacts to human health or the environment we recommend the following new enhanced monitoring program:

Wells to be Sampled Twice Annually in the Spring and Fall	Parameters
OW1-83 TH4-02 OW2-83 TH6-81 OW3-83 TH7-81 OW4-83 TH8-81 OW5-19 OW6-19	Chloride, sulphate, pH, phenols, nitrite, nitrate, TKN, total phosphorous, hardness, conductivity, ammonia, alkalinity, DOC, BOD, COD, and Al, Sb, As, Ba, B, Be, Ca, Cd, Co, Cr, Cu, Fe, Pb, Mg, Mn, Mo, Ni, K, Se, Ag, Si, Na, Sr, Ti, Tl, U, V, Zn.
Surface Water to be Sampled Twice Annually in the Spring and Fall	Parameters
SP2-85 SP2A-85 SP3-85 SP4-85 SP5-88 SS1-99	pH, conductivity, hardness, alkalinity, phenols, TKN, total phosphorous, dissolved organic carbon (DOC), chloride, sulphate, nitrite, nitrate, ammonia, and metals (i.e., Ca, Mg, As, Fe and Na).
SP1-83	pH, conductivity, hardness, alkalinity, chloride, sulphate, phenols, nitrate, nitrite, ammonia, TKN, total phosphorous and metals (i.e., Ca, Mg, As, Na, K and Fe).
Leachate Collection to be Sampled Twice Annually in the Spring and Fall	Parameters
LW1-11 MH-7A MH-8	Alkalinity, pH, conductivity, hardness, chloride, phenols, ammonia, nitrite, nitrate, TKN, total phosphorous, BOD, DOC, COD, and metals (i.e., Ca, K and Na).

All of which is respectfully submitted,

GM BLUEPLAN ENGINEERING LIMITED

Per:

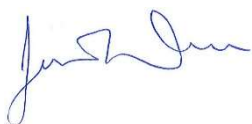

J. K. Weller, C.E.T.

Per:



M. D. Nelson, M.Sc., P.Eng.

TABLES:

**TABLE 1
SITE SPECIFIC BACKGROUND CONCENTRATIONS AND
GUIDELINE B-7-1 RUC DETERMINATION
CHESLEY LANDFILL SITE**

GROUNDWATER INDICATOR PARAMETERS CHESLEY LANDFILL SITE					
Parameter (mg/L)	Maximum Concentration (Cr)	ODWS Classification	Background Concentration Range [n]	Background Concentration (Cb)	Objective Level (Cm)
Alkalinity	500	OG	175 - 340 [7]	274	387
Ammonia	NV	NV	0.01 - 2.13 [64]	0.23	NV
Calcium	NV	NV	13.2 - 141 [74]	52.1	NV
Chloride	250	AO	4.4 - 174 [74]	16.8	133
Conductivity (uS/cm)	NV	NV	374 - 1210 [74]	602	NV
DOC	5	AO	0.3 - 13 [41]	2.6	3.8
Hardness	80 to 200	OG	189 - 462 [75]	305	336
Iron	0.3	AO	0.014 - 4.25[14]	1.44	0.87
Magnesium	NV	NV	14.8 - 57.5 [74]	42.1	NV
Nitrate	10	MAC	<0.1 - 0.5 [33]	0.22	2.67
Nitrite	1	MAC	0.01 [33]	0.01	0.26
pH (no units)	6.5 to 8.5	OG	7.05 - 8.38 [75]	7.78	6.5 to 8.5
Phenols	NV	NV	1 - 23 [64]	1.9	NV
Sodium	200	AO	3.5 - 16.2 [10]	9.1	105
Sulphate	500	AO	2 - 44 [15]	20.1	260
Total Kjeldahl Nitrogen	NV	NV	0.06 - 4.24 [34]	0.69	NV

Notes:

1. [n] = number of data points used to determine the average background concentration.
2. Available data from OW4-83 collected from 1983 to 2019 was used to calculate background concentrations.
3. mg/L = milligrams per litre; uS/cm = microsiemens per centimetre; NV = No Value.
4. AO = Aesthetic Objective; OG = Operational Guideline
MAC = Maximum Acceptable Concentration, Parameters Related to Health
IMAC = Interim Maximum Acceptable Concentration, Parameters Related to Health

MOE Procedure B-7-1

$$C_m = C_b + x(C_r - C_b)$$

Where:

- C_m = Maximum concentration acceptable in groundwater beneath an adjacent property.
- C_b = Background concentration.
- C_r = Maximum concentration that should be present in groundwater for domestic consumption according to the Ontario Drinking Water Standards (ODWS).
- x = 0.5 for non-health related parameters and 0.25 for health related parameters.

5. Where the C_b > C_r, the average background value is used as the RUC.

Table 2: Summary of Groundwater Quality Data Compared to the RUC

Spring Sampling Event

Well ID Sample Date Well Depth (m bgs) Parameter	Background for RUC Calc.	ODWS	RUC	Background	Upgradient				Downgradient					
				Northeast	Southeast	Southwest	Southeast	Northwest	Northwest	North	North	North	North	
				OW4-83	OW6-19	TH4-02	OW3-83	TH6-81	TH8-81	OW5-19	OW1-83	OW2-83	TH7-81	
				11-Apr-23										
				13.3	3.4	3.1	6.5	3.0	3.4	3.2	12.3	6.3	3.5	
pH (no units)	7.78	6.5 to 8.5	OG	6.5 to 8.5	7.9	7.5	7.8	8.2	7.5	8.0	7.8	8.2	8.4	8.0
Conductivity (uS/cm)	602	NV	NV	NV	761	1330	971	454	1770	535	728	558	461	440
Alkalinity	274	500	OG	387	304	564	406	217	544	218	363	153	200	202
Hardness	305	80 to 200	OG	336	325	704	491	244	1170	282	425	194	253	235
Chloride	16.8	250	AO	133	61	35	63	14	3.2	1.6	1.4	87	10	5.6
Nitrate	0.22	10	MAC	2.67	< 0.05	< 0.05	< 0.05	< 0.05	< 0.05	0.07	< 0.05	< 0.05	< 0.05	< 0.05
Nitrite	0.01	1	MAC	0.26	0.11	0.15	0.20	0.09	0.24	0.23	0.22	0.05	0.28	0.27
Sulphate	20.1	500	AO	260	2.0	136	19	4.0	535	64	29	< 1	35	21
Ammonia	0.23	NV	NV	NV	0.75	0.12	0.13	0.09	0.08	0.24	0.11	0.07	0.03	0.02
Total Kjeldahl Nitrogen (TKN)	0.69	NV	NV	NV	0.90	0.40	1.1	0.20	0.50	3.8	0.5	0.2	0.1	0.1
Phenols	1.9	NV	NV	NV	< 0.001	< 0.001	< 0.001	< 0.001	< 0.001	< 0.001	< 0.001	< 0.001	< 0.001	< 0.001
Calcium	52.1	NV	NV	NV	90	166	106	26	289	50	117	12	13	52
Magnesium	42.1	NV	NV	NV	24	70	55	44	109	38	32	40	54	26
Sodium	9.1	200	AO	105	42	50	35.0	9.0	8.0	15	9.5	39	8.5	13

Fall Sampling Event

Well ID Sample Date Well Depth (m bgs) Parameter	Background for RUC Calc.	ODWS	RUC	Background	Upgradient				Downgradient					
				Northeast	Southeast	Southwest	Southeast	Northwest	Northwest	North	North	North	North	
				OW4-83	OW6-19	TH4-02	OW3-83	TH6-81	TH8-81	OW5-19	OW1-83	OW2-83	TH7-81	
				2-Nov-23										
				13.3	6.0	3.1	6.5	3.0	3.4	6.3	12.3	6.3	3.5	
pH (no units)	7.78	6.5 to 8.5	OG	6.5 to 8.5	7.9	7.9		8.2		8.0	7.8	8.2	8.3	
Conductivity (uS/cm)	602	NV	NV	NV	731	851		440		698	744	532	433	
Alkalinity	274	500	OG	387	293	394		215		321	374	137	200	
Hardness	305	80 to 200	OG	336	288	416		219		445	386	176	222	
Chloride	16.8	250	AO	133	72	27		18		0.70	1.0	102	15	
Nitrate	0.22	10	MAC	2.67	<0.05	0.29		0.12		0.58	0.11	<0.05	0.13	
Nitrite	0.01	1	MAC	0.26	<0.05	<0.05		<0.05		<0.05	<0.05	<0.05	<0.05	
Sulphate	20.1	500	AO	260	<1.0	58		9.0		68	44	<1.0	23	
Ammonia	0.23	NV	NV	NV	1.0	0.31		0.14		0.06	0.09	0.21	0.09	
Total Kjeldahl Nitrogen (TKN)	0.69	NV	NV	NV	1.2	0.60		0.80		0.40	0.20	3.9	0.50	
Phenols	1.9	NV	NV	NV	<0.001	<0.001		<0.001		<0.001	<0.001	<0.001	<0.001	
Calcium	52.1	NV	NV	NV	74	88		20		86	101	14	10	
Magnesium	42.1	NV	NV	NV	25	48		41		56	32	35	48	
Sodium	9.1	200	AO	105	43	23		8.1		13	7.0	36	9.0	

Notes:

1. ODWS = Ontario Drinking Water Standards (June 2003, Revised June 2006)
2. AO: Aesthetic Objective; OG = Operational Guideline; MAC = Maximum Acceptable Concentration; IMAC = Interim Maximum Acceptable Concentration.
3. Background values used to calculate the Reasonable Use Criteria are from OW4-8 from 1983 to 2020.
3. NV = no value specified
4. Shaded values represent results greater than the Reasonable Use Criteria
5. Bolded values represent results greater than the ODWS
6. Samples Analyzed at Caduceon Environmental Laboratories
7. Results presented in mg/L (milligrams per litre) unless otherwise specified. µS/cm = microsiemens per centimeter.
8. TH2-02 was replaced by OW6-19 and TH1-82 was replaced by OW5-19 in the Fall of 2019.

Table 3: Summary of Surface Water Quality in 2023

Sample Location Sample Date	PWQO	CCME	Spring 2023							Fall 2023						
			Upstream N. Saugeen River	Downstream N. Saugeen River	South Drainage Channel	Upstream North Drainage Channel	Midstream North Drainage Channel	Midstream North Drainage Channel	Downstream North Drainage Channel	Upstream N. Saugeen River	Downstream N. Saugeen River	South Drainage Channel	Upstream North Drainage Channel	Midstream North Drainage Channel	Midstream North Drainage Channel	Downstream North Drainage Channel
			SP3-85	SP4-85	SS1-99	SP2A-85	SP2-85	SP1-83	SP5-88	SP3-85	SP4-85	SS1-99	SP2A-85	SP2-83	SP1-83	SP5-88
Parameter	(mg/L)	(mg/L)	11-Apr-23							2-Nov-23						
Field Temperature (°C)	NV	NV	7.0	7.0	5.0	5.0	7.0	7.0	5.0	7.0	7.0	8.0	7.0	6.0		
Calcium	NV	NV	46	48	78	97	95	112	90	57	56	112	117	114		
Magnesium	NV	NV	19	20	26	23	23	37	33	28	27	36	29	27		
Sodium	NV	NV	3.3	3.4	3.6	17	19	14	9.8	4.1	4.1	5.9	17	30		
Chloride	NV	120	6.1	6.1	10	32	37	23	18	8.5	8.3	15	35	54		
Total Phosphorous	0.03 ug/L (General Guideline)	NV	0.03	0.03	0.05	0.08	0.03	0.16	0.02	<0.01	0.01	0.06	0.03	0.07		
Phenols	0.0001	0.004	< 0.001	< 0.001	< 0.001	< 0.001	< 0.001	< 0.001	< 0.001	< 0.001	< 0.001	< 0.001	< 0.001	< 0.001		
Nitrate	13 (2.9 as N) ²	13	0.63	0.63	10	1.2	1.6	1.7	2.0	0.67	0.67	26	2.6	1.7		
Sulphate	nv	NV	4.0	4.0	13	7.0	7.0	23	33	6.0	6.0	18	7.0	6.0		
pH (Units)	6.5 to 8.5	7.0 to 8.7	8.2	8.3	8.3	8.2	8.2	8.1	8.2	8.2	8.2	8.1	8.1	8.0		
Alkalinity	***	NV	189	189	254	305	295	373	323	243	247	338	391	409		
Total Ammonia	NV	NV	0.01	0.01	0.02	0.02	0.02	1.07	< 0.01	< 0.05	< 0.05	< 0.05	< 0.05	0.65		
Ammonia (un-ionized) ³	0.02	0.019	0.001	0.001	0.001	0.001	0.001	0.001	0.001	0.001	0.001	0.001	0.001	0.001		
Calculated Hardness	NV	NV	196	203	299	336	329	442	361	256	251	428	410	397		
Specific Conductance	NV	NV	387	390	601	678	684	811	722	468	466	826	789	879		
Iron	0.3	NV	0.07	0.07	0.06	0.37	0.28	< 0.005	0.06	0.04	0.04	0.38	0.14	2.3		
Arsenic	0.005	0.005	0.0002	0.0002	0.0002	0.0005	0.0006	0.01	0.0002	0.0002	0.0002	0.0003	0.0004	0.0008		

Notes:

1. Analytical results are reported in mg/L unless otherwise noted
2. IPWQO: Interim Provincial Water Quality Objective
3. Corrected using temperature and pH (as described in the PWQO)
4. *** Alkalinity should not be decreased by more than 25% of the natural concentration
5. Values shaded and in **BOLD** indicate exceedance of PWQO
6. The site-specific chloride limit, used to access surface water quality, was set at 250 mg/L by the MECP (correspondence dated June 22, 2006)
7. The site-specific nitrate (nitrate[as N]) limit, used to access surface water quality, was set at 13 mg/L NO3 (or 2.9 mg/L NO3 as N) by MECP (correspondence dated June 22, 2006)
9. NV = No value specified.

**Table 4
Summary of Leachate Collection System Quality Data**

Parameter	Well ID Sample Date	Background	ODWS	RUC	Leachate collection System		Leachate Well	Leachate collection System		Leachate Well	
					MH-7A	MH-8	LW1/11	MH-7A	MH-8	LW1/11	
					11-Apr-23			2-Nov-23			
pH (no units)		7.78	6.5 to 8.5	OG	6.5 to 8.5	7.9	8.0	7.5	7.9	7.8	7.4
Conductivity (uS/cm)		602	NV	NV	NV	747	745	926	711	716	955
Hardness		305	80 to 200	OG	336	345	393	505	368	367	495
Chloride		16.8	250	AO	133	18	18	26	17	17	31
Nitrate		0.22	10	MAC	2.67	2.6	2.6	0.12	4.2	3.6	<0.05
Nitrite		0.01	1	MAC	0.25	<0.05	0.1	<0.05	<0.05	<0.05	<0.05
DOC		2.6	5	AO	3.80	1.7	2.9	6.6	4.4	3.3	7.2
Ammonia		0.23	NV	NV	NV	1.1	1.8	2.5	<0.05	<0.05	<0.05
Total Kjeldahl Nitrogen (TKN)		0.69	NV	NV	NV	1.5	1.9	2.7	2.1	1.5	6.2
Phenols		1.9	NV	NV	NV	<0.001	0.001	0.006	<0.001	<0.001	0.001
Calcium		52.1	NV	NV	NV	85	96	127	89	89	133
Magnesium		42.1	NV	NV	NV	32	37	36	35	35	40
Sodium		9.1	200	AO	105	12	13	19	10	11	17

Notes:

1. ODWS = Ontario Drinking Water Standards (June 2003, Revised June 2006)
2. AO: Aesthetic Objective; OG = Operational Guideline; MAC = Maximum Acceptable Concentration; IMAC = Interim Maximum Acceptable Concentration.
3. NV = no value specified
4. Shaded values represent results greater than the Reasonable Use Criteria
5. Bolded values represent results greater than the ODWS
6. Samples Analyzed at Caduceon Environmental Laboratories
7. Results presented in mg/L (milligrams per litre) unless otherwise specified. $\mu\text{S/cm}$ = microsiemens per centimeter.

FIGURES:

219126
 Annual Monitoring Report
 Chesley Landfill
 Municipality of Arran-Elderslie



LEGEND:

- — — — — LANDFILL PROPERTY (6.4 Ha)
- • • • • APPROVED FILL AREA (2.4 Ha)
- — — — — ADDITIONAL CAZ LANDS OWNED BY THE MUNICIPALITY
- ⊕ SP3-85 SURFACE WATER SAMPLE LOCATION

Scale = 1:1,500
 JANUARY 2024

**SITE LOCATION MAP AND
 LANDFILL PROPERTY
 BOUNDARY**

Figure No. 1



219126
 Annual Monitoring Report
 Chesley Landfill
 Municipality of Arran-Elderslie



LEGEND:

- LANDFILL PROPERTY (6.4 Ha)
- APPROVED FILL AREA (2.4 Ha)
- OW5-19 MONITORING WELL LOCATION
- SP5-85 SURFACE WATER SAMPLE LOCATION
- APPROXIMATE LOCATION OF SNOW STORAGE

Scale = 1:1,500
 JANUARY 2024

**SITE PLAN SHOWING
 MONITORING LOCATIONS**

Figure No. 2

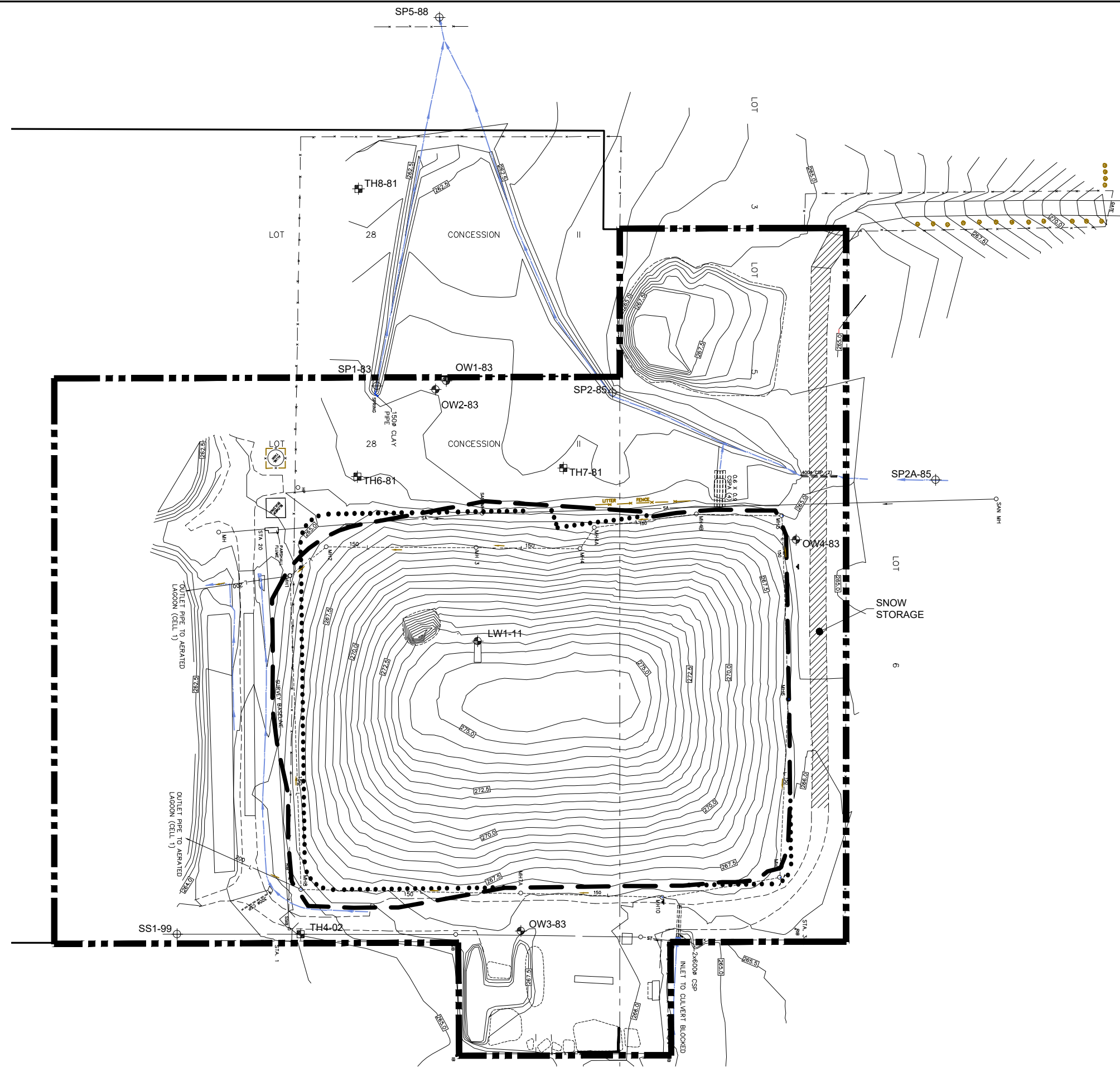





GMBP FILE: 219126 AMR_Figs.dwg LAYOUT: Fig. (2)
 LAST SAVED: 2/3/2024 7:53:24 AM PLOTTED: 2/3/2024 7:53:50 AM

219126
Annual Monitoring Report
Chesley Landfill
Municipality of Arran-Elderslie

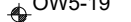

LEGEND:

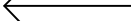
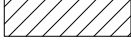
-  LANDFILL PROPERTY (6.4 Ha)
-  APPROVED FILL AREA (2.4 Ha)
-  OW5-19 MONITORING WELL LOCATION
-  GROUNDWATER CONTOUR
-  GROUNDWATER FLOW
-  APPROXIMATE LOCATION OF SNOW STORAGE

NOTE:
GROUND WATER LEVELS
(GWL) RECORDED IN 2023

Scale = 1:1,500
JANUARY 2024

SPRING GROUNDWATER
FLOW DIRECTION AND
CHLORIDE CONCENTRATIONS
(SPRING 2023)



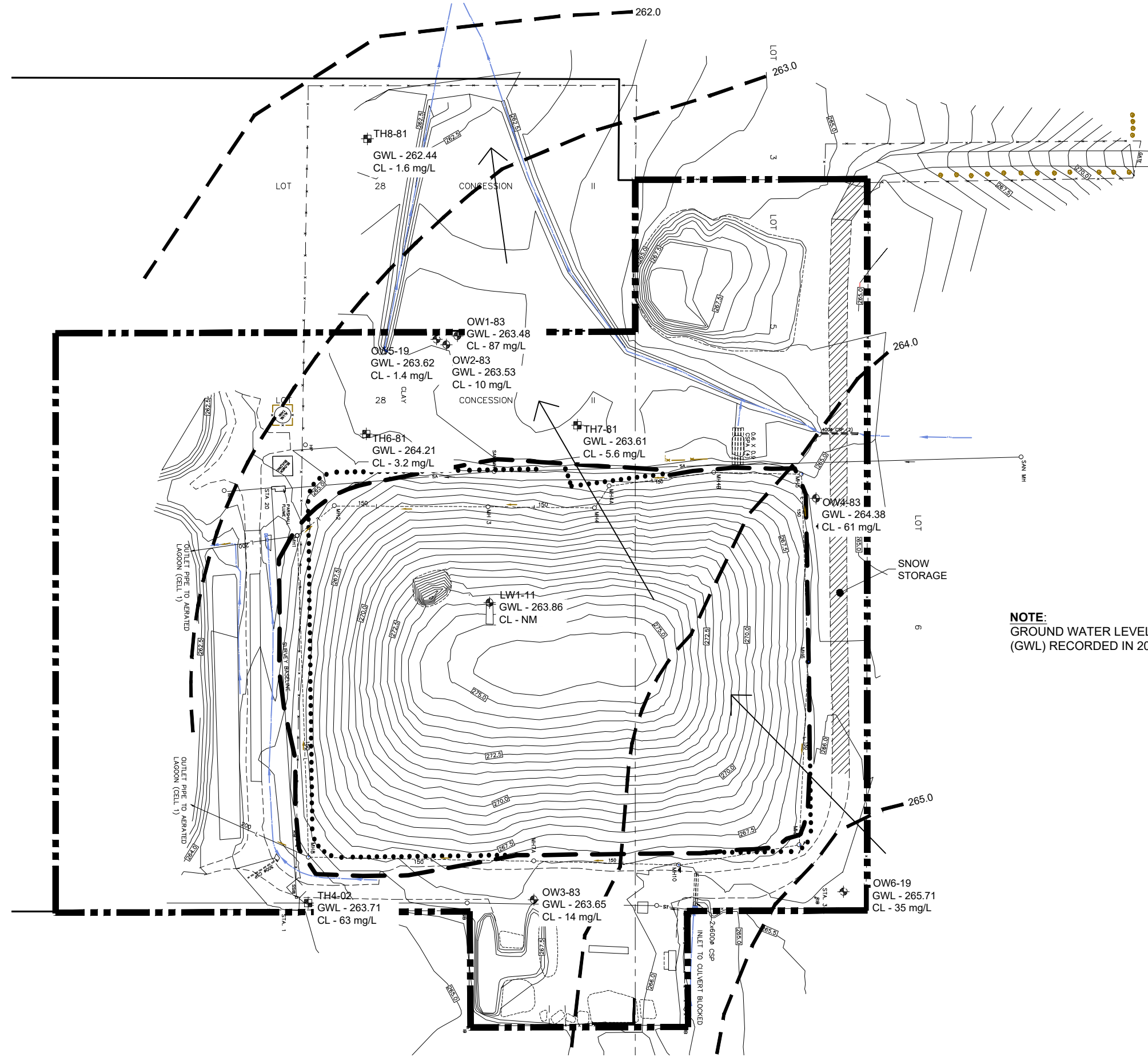
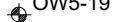

Figure No. 3



219126
Annual Monitoring Report
Chesley Landfill
Municipality of Arran-Elderslie

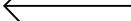
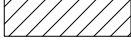

LEGEND:

-  LANDFILL PROPERTY (6.4 Ha)
-  APPROVED FILL AREA (2.4 Ha)
-  OW5-19 MONITORING WELL LOCATION
-  GROUNDWATER CONTOUR
-  GROUNDWATER FLOW
-  APPROXIMATE LOCATION OF SNOW STORAGE

Scale = 1:1,500
JANUARY 2024

FALL GROUNDWATER FLOW
DIRECTION AND CHLORIDE
CONCENTRATIONS
(FALL 2023)

Figure No. 4

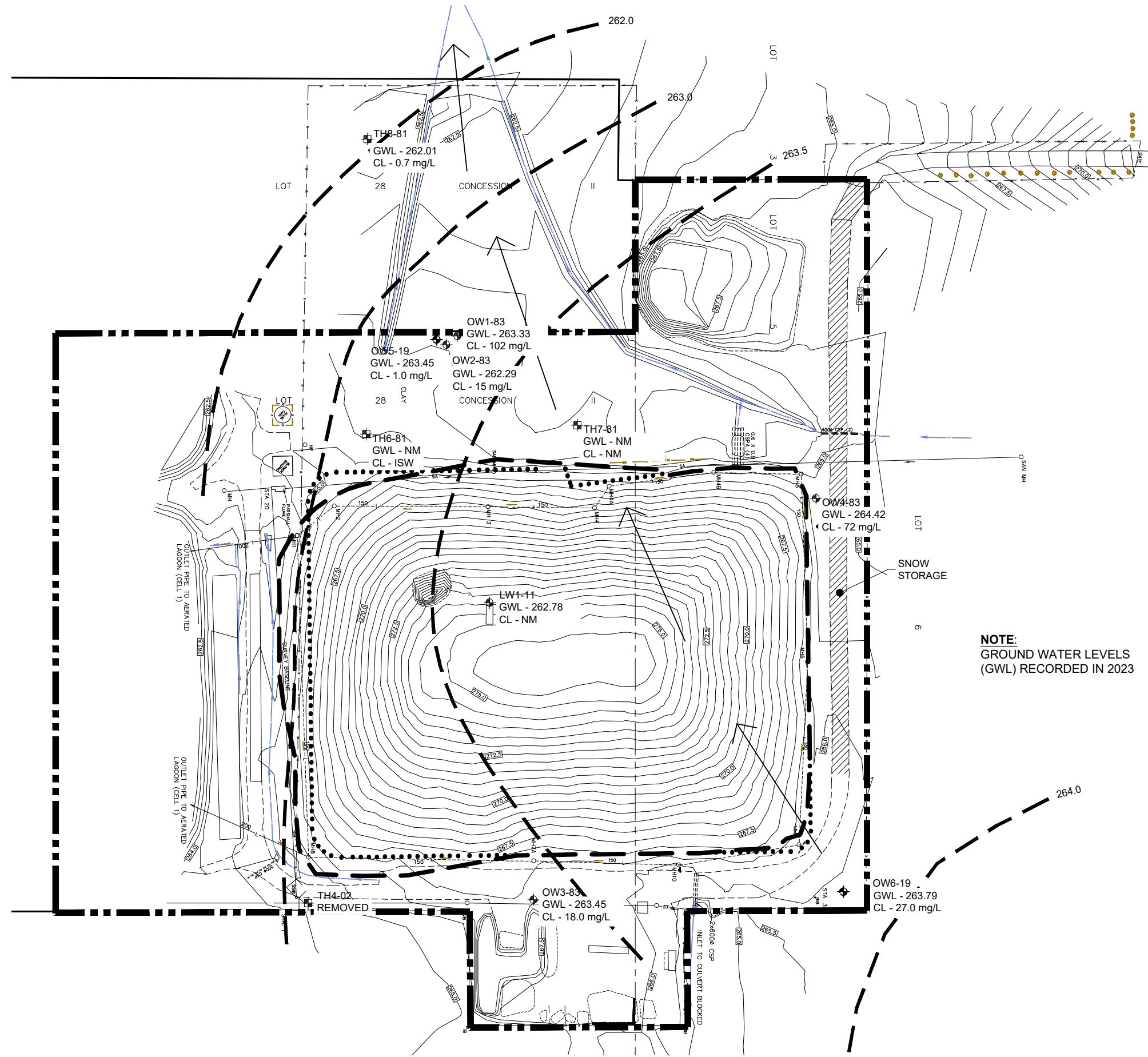

NOTE:
GROUND WATER LEVELS
(GWL) RECORDED IN 2023

GMBP FILE: 219126 AMR Figs.dwg LAYOUT: Fig. (4)
LAST SAVED: 2/3/2024 8:28:03 AM PLOTTED: 2/3/2024 8:28:32 AM

**APPENDIX A:
CERTIFICATE OF APPROVAL NO. A272402**



Ontario

Ministry of the Environment
Ministère de l'Environnement

AMENDED PROVISIONAL CERTIFICATE OF APPROVAL
WASTE DISPOSAL SITE
NUMBER A272402

The Corporation of the Municipality of Arran-Elderslie
P.O. Box 70, 1925 County Road 10
Chesley, Ontario
N0G 1L0

Site Location: Chesley Landfill Site
Part of Lots 5 and 28, Concession 2 and
Parts of King and Spring Streets and
Part of Lot 28, Concession 1
Municipality of Arran-Elderslie, County of Bruce

You have applied in accordance with Section 27 of the Environmental Protection Act for approval of:

for the use and operation of a 2.4 hectare landfilling and ancillary waste diversion activities, within a total site area of 6.4 hectares

or the purpose of this Certificate of Approval and the terms and conditions specified below, the following definitions apply:

- (a) "Act" means the *Environmental Protection Act, R.S.O. 1990, C.E-19*, as amended;
- (b) "Buffer" means those lands between the Limit of Fill and the boundaries of the property owned by the Owner and shall in no instance be less than 18 metres on the eastern boundary, 20 metres on the southern boundary and 30 metres on the western and northern boundaries;
- (c) "Certificate" means this Provisional Certificate of Approval;
- (d) "clean wood" means wood or a wood product, including tree trucks, tree branches, leaves and brush, that:
 - (i) is not contaminated with chromated copper arsenate, ammoniacal copper arsenate, pentachlorophenol or creosote; and
 - (ii) from which easily removable hardware, fittings and attachments, unless they are predominantly wood or cellulose, have been removed; and
 - (iii) is not an upholstered articles; and
 - (iv) does not have a rigid surface treatment affixed or adhered to it, unless the rigid surface treatment is predominantly wood or cellulose;

- (c) "Competent" means knowledgeable, through instruction and practice, in all of the following;
 - (i) relevant waste management legislation, regulations and guidelines;
 - (ii) major environmental concerns pertaining to the waste to be handled;
 - (iii) emergency response procedures for the waste to be handled;
 - (iv) use and operation of any equipment to be used;
 - (v) emergency response procedures and alerting;
 - (vi) Owner specific written procedures for the control of conditions that may cause an adverse effect; and
 - (vii) requirements of this Certificate;
- (f) "Director" means Director, Environmental Assessment and Approvals Branch, Ontario Ministry of the Environment;
- (g) "District Manager" means District Manager, Owen Sound Office, Ontario Ministry of the Environment;
- (h) "household hazardous waste" and "HHW" means waste classes 145, 148, 213, 242, 261 and 331 as defined in Ontario Regulation 347, generated by households located in the geographic boundaries of the Municipality of Arran-Elderslie;
- (i) "Interim closure" means an extended period of time during which the Site is not actively operating but is not recognized as permanently closed;
- (j) "Limit of Fill" means the area in which waste is approved for final disposal according to this Certificate;
- (k) "Ministry" and "MOE" means the Ontario Ministry of the Environment;
- (l) "municipal waste" means municipal waste as defined in Ontario Regulation 347;
- (m) "OWRA" means the *Ontario Water Resources Act*, R.S.O. 1990, c. O.40, as amended;
- (n) "Ontario Regulation 189" means Ontario Regulation 189/94, Refrigerants, or as amended, made under the Act;
- (o) "Ontario Regulation 347" means Ontario Regulation 347 - R.R.O. 1990, General - Waste Management, as amended from time to time, made under the Act;
- (p) "Ontario Regulation 362" means Ontario Regulation 362 - R.R.O. 1990, Waste Management - PCBs, or as amended, made under the Act;
- (q) "Owner" means the Municipality of Arran-Elderslie, including its officers, employees and agents and any person(s) contracted by the Municipality of Arran-Elderslie to manage operations on the Site on behalf of the Owner;

- (r) "PCB" means monochlorinated and polychlorinated biphenyls or any mixture of them or any mixture that contains one or more of them;
- (s) "PWQO" means the Provincial Water Quality Objectives included in the July 1994 publication entitled *Water Management Policies, Guidelines, Provincial Water Quality Objectives*, as amended from time to time;
- (t) "RUP" means the Reasonable Use Policy (Guideline B-7) of the Ministry of the Environment;
- (u) "Scavenging" means the uncontrolled removal of reusable material from waste at a waste disposal site;
- (v) "Sharps" mean medical implements and equipment intended to be sharp for the purpose of cutting or piercing and includes needles, blades and lancets;
- (w) "Site" means the property consisting of Part of Lots 5 and 28, Concession 2, Parts of King and Spring Streets and Part of Lot 28, Concession 1, former Town of Chesley, Municipality of Arran-Elderslie, County of Bruce; and
- (x) "white goods which contain refrigerants" means white goods which contain, or may contain refrigerants, and which include, but is not restricted to, refrigerators, freezers and air-conditioning systems.

u are hereby notified that this approval is issued to you subject to the terms and conditions outlined below:

TERMS AND CONDITIONS

General

1. This Provisional Certificate of Approval supersedes and replaces Provisional Certificate Number A272402 issued March 7, 1985 and amendments issued on June 7, 1991, January 30, 1998, May 21, 1998 and April 11, 2000.
2. Except as otherwise provided by these Conditions, the Site shall be designed, developed, used, maintained and operated, and all facilities, equipment and fixtures shall be built and or installed in accordance with the supporting documentation, and plans and specifications listed in Schedule "A".
3. The requirements specified in this Certificate are requirements under the Act. Issuance of this Certificate in no way abrogates the Owner's legal obligations to take all reasonable steps to avoid violating other applicable provisions of this legislation and other legislation and regulations.

4. The requirements of this Certificate are severable. If any requirements of this Certificate, or the application of any requirement of this Certificate to any circumstance, is held invalid, the application of such requirement to other circumstances and the remainder of this Certificate shall not be affected in any way.
5. The Owner must ensure compliance with all terms and conditions of this Certificate. Any non-compliance constitutes a violation of the Act and is grounds for enforcement.
6. (a) The Owner shall, forthwith upon request of the Director, District Manager, or Provincial Officer (as defined in the Act), furnish any information requested by such persons with respect to compliance with this Certificate, including but not limited to, any records required to be kept under this Certificate; and
(b) In the event the Owner provides the Ministry with information, records, documentation or notification in accordance with this Certificate (for the purposes of this condition referred to as "Information"),
 - (i) the receipt of Information by the Ministry;
 - (ii) the acceptance by the Ministry of the Information's completeness or accuracy; or
 - (iii) the failure of the Ministry to prosecute the Owner, or to require the Owner to take any action, under this Certificate or any statute or regulation in relation to the Information;shall not be construed as an approval, excuse or justification by the Ministry of any act or omission of the Owner relating to the Information, amounting to non-compliance with this Certificate or any statute or regulation.
7. The Owner shall allow Ministry personnel, or a Ministry authorized representative(s), upon presentation of credentials, to:
 - (a) carry out any and all inspections authorized by Section 156, 157 or 158 of the Act, Section 15, 16 or 17 of the OWRA, or Section 19 or 20 of the Pesticides Act, R.S.O. 1990, as amended from time to time, of any place to which this Certificate relates; and,
 - (b) without restricting the generality of the foregoing, to:
 - (i) enter upon the premises where records required by the conditions of this Certificate are kept;
 - (ii) have access to and copy, at reasonable times, any records required by the conditions of this Certificate;
 - (iii) inspect at reasonable times any facilities, equipment (including monitoring and control equipment), practices, or operations required by the conditions of this Certificate; and
 - (iv) sample and monitor at reasonable times for the purposes of assuring compliance with the conditions of this Certificate.

8. Where there is a conflict between a provision of any document referred to in Schedule "A", and the conditions of this Certificate, the conditions in this Certificate shall take precedence. Where there is a conflict between the documents listed in Schedule "A", the document bearing the most recent date shall prevail.
9. Any information relating to this Certificate and contained in Ministry files may be made available to the public in accordance with the provisions of the *Freedom of Information and Protection of Privacy Act*, R.S.O. 1990, C. F-31.
10. All records and monitoring data required by the conditions of this Certificate must be kept on the Owner's premises for a minimum period of five (5) years from the date of their creation.

Notification

11. The Owner shall ensure that all communications/correspondence made pursuant to this Provisional Certificate of Approval reference Certificate No. A272402.
12. The Owner shall notify the Director in writing of any of the following changes, within thirty (30) days of the change occurring:
 - (a) change in name and/or address of Owner;
 - (b) change of ownership of Site;
 - (c) change of partners where the Owner is or at any time becomes a partnership, and a copy of the most recent declaration filed under the *Business Names Act*, 1991 shall be included in the notification to the Director; and
 - (d) any change of name of the corporation where the Owner is or at any time becomes a corporation, and a copy of the most current "Initial Notice or Notice of Change" (form 1 or 2 of O. Regulation 182, Chapter C-39, R.R.O. 1990, as amended from time to time); filed under the *Corporations Information Act* shall be included in the notification to the Director.

Certificate of Prohibition

13. Pursuant to Section 197 of the Act, no person having an interest in the Site shall deal in any way with the Site without first giving a copy of this Certificate to each person acquiring an interest in the Site as a result of the dealing.
14. The Owner shall:
 - (a) Within sixty (60) calendar days of the date of this Certificate, submit to the Director for the Director's signature two (2) copies of a completed Certificate of Prohibition containing a registerable description of the Site, in accordance with Form 1 of O. Reg. 14/92 (Document General - Form 4 - *Land Registration Reform Act*); and
 - (b) Within ten (10) calendar days of receiving the Certificate of Prohibition signed by the Director, register the Certificate of Prohibition in the appropriate Land Registry Office on title to the Site and submit to the Director immediately following registration the duplicate registered copy.

Site Operations - General

15. The Site shall accept only municipal waste generated within the geographic area of the Municipality of Arran-Elderslie.
16. The Owner may set hours of operation of the Site to be any day of the week, during daylight hours. The hours of operation shall be posted at the entrance gate. The Owner may change the hours of operation provided that the change is preceded by notification of the public and the hours are correctly posted at the entrance gate.
17. No waste shall be received for disposal at the Site except during operating hours and while the Site is under the supervision of the Site attendant.
18. During non-operating hours, the Site entrance gate shall be locked and secured against access by unauthorized persons.
19. The Owner shall post a sign at the entrance gate of the Site with the following information:
 - (a) name of the Site and Owner
 - (b) Certificate of Approval Number for the Site
 - (c) days and hours of operation
 - (d) allowable and prohibited waste types in the landfill
 - (e) municipal contact telephone number(s) available 24 hours
 - (f) warning against unauthorized access and against dumping outside the Site
 - (g) tipping fee schedule
20. The Owner shall ensure that:
 - (a) access to the Site is restricted by fencing and/or natural features;
 - (b) no later than May 31, 2005, access from the Site to the waste stabilization ponds is restricted by fencing; and
 - (b) all fencing and lockable gates are kept in good repair.

Site Operations - Landfill

21.
 - (a) The Site shall be operated and developed in consecutive sequences as described in Item 2 of Schedule "A"; and
 - (b) The leachate collection system shall be constructed by the Owner in accordance with Item 2 of Schedule "A".
22.
 - (a) The operational life of the Site shall be limited to the time until final contours shown on Figure 6 of Item 2, Schedule "A" have been reached; and
 - (b) The volumetric capacity shall be reduced by $1,410 \text{ m}^3$ in accordance with Item 9 of Schedule "A", by raising the landfill bottom contours approximately 0.27 metres in the undeveloped part of the Site within an area of approximately $5,200 \text{ m}^2$.

23. No waste shall be landfilled on the additional property described in Schedule "A", Items 5 to 8.
24. The Owner shall deposit waste in a manner that minimizes the exposure of the working face of the landfilling area and shall be compacted before cover material is applied.
25. The Owner shall ensure that cover material is applied to all exposed waste material at the end of each working day. The average depth of this material when soil is used shall be 15 cm.
26. The Owner shall ensure that no burning of municipal waste takes place on the Site except for the burning of clean, untreated wood waste and brush as follows:
 - (a) burning shall be conducted only in the designated burn area that is screened by an earth berm;
 - (b) the burn pile shall be no more than five (5) m² in area and three (3) m in height;
 - (c) no burning is to occur without the supervision of the Owner;
 - (d) no burning is to occur during air quality advisory days; and
 - (e) access to the burning area by the public and other unauthorized personnel is prohibited when burning is being carried out.
27. Six (6) months prior to interim closure of the Site, the Owner shall submit to the District Manager for approval, a detailed interim Site closure plan which includes, but is not limited to, the following:
 - (a) schedule and plans for Site inspections, maintenance and monitoring;
 - (b) details regarding interim cover; and
 - (c) Site security.
28. Two (2) years prior to the time the Site reaches its approved capacity, the Owner shall submit to the Director for approval, a detailed Site closure plan which includes, but is not limited to, the following:
 - (a) post-closure inspection procedures and schedule;
 - (b) maintenance and monitoring plan; and
 - (c) proposed end use of the Site.

Site Operations - Waste Diversion

29. All waste destined for diversion shall be segregated either into bins or in designated areas as defined by barriers. All bins and designated waste storage areas shall be clearly labelled.

10. The Owner shall ensure that:
- (a) all white goods which contain refrigerants accepted at the Site, which have not been tagged by a licensed technician to verify that the equipment no longer contains refrigerants, are stored in an upright position and in such a manner to allow for the safe handling and removal from the Site for removal of refrigerants as required by Ontario Regulation 189;
 - (b) white goods which contain refrigerants received on-site shall either have the refrigerant removed prior to removal from the Site or shall be shipped off-site only to facilities where the refrigerants can be removed by a licensed technician in accordance with Ontario Regulation 189; and
 - (c) a detailed log of all white goods which contain refrigerants received is maintained which includes the following information:
 - (i) date of the record;
 - (ii) types, quantities and source of white goods which contain refrigerants received;
 - (iii) destination of the white goods; or
 - (iv) the details on removal of refrigerants, if conducted on Site, and the quantities and destination of the refrigerants transferred from the Site.
31. Propane cylinders shall be stored in a segregated area in a manner which prevents cylinders from being knocked over or cylinder valves from breaking.
32. Tires shall be placed in a segregated area cleared of vegetation and other waste, in a pile no greater than 3 m in height and 100 m² in area.
33. Leaf and yard waste destined for composting shall be stored on a concrete pad. Waste shall be removed to a composting facility on an annual basis or whenever the capacity of the concrete pad is reached, whichever occurs first. In the event that waste becomes odorous, the waste will be removed immediately.

Site Operations - HHW

34. The hazardous waste depot shall be developed, operated and maintained in accordance with these Conditions and the plans and specifications in Items 11 and 13 of Schedule "A".
35. Hazardous waste received at the Site shall be limited to waste classes 145, 148, 213, 242, 261 and 331 as defined in Ontario Regulation 347, generated in the geographic area of the Municipality of Arran-Elderslie.
36. The Owner shall ensure that:
- (a) hazardous wastes that are received and stored on Site shall be in amounts which can be safely handled on the Site;
 - (b) all HHW shall be stored indoors except for waste paint which may be stored outdoors in enclosed 205L drums;
 - (c) the indoor storage area is equipped with impermeable floor such that any material spilled is contained and can be readily cleaned-up;
 - (d) all liquid HHW is stored within secondary containment;

- (e) the indoor storage area is equipped with spill clean-up material; and
 - (f) the indoor storage area is equipped with a means of ventilation.
17. The Owner shall ensure that:
- (a) HHW shall only be received at the Site during those hours when a dedicated trained person can directly supervise the operation; and
 - (b) all incoming HHW shall be inspected by a trained person, prior to being accepted at the Site.
18. Storage containers shall be clearly labelled indicating the type and nature of the hazardous waste stored.
19. (a) The following wastes shall not be mixed (bulked) with any other waste unless tested and found to contain less than 50 ppm PCBs:
- (i) oil-based paints which have been manufactured prior to 1972 or whose manufacturing date cannot be determined;
 - (ii) unidentified oils; or
 - (iii) oils which are suspected of containing PCB's.
- (b) Waste which are lab-packed are not considered to be mixed under this Certificate.

Litter Control

40. The Owner shall implement a litter control program consisting of:
- (a) a main litter cleanup carried out in the spring after the snow cover melts;
 - (b) weekly litter cleanup along the perimeter of the Site and the access road during the spring, summer and fall seasons; and
 - (c) the use of mobile litter fencing adjacent to the landfill working face.

Record Keeping

41. The Owner shall keep records of the types, quantities and destination of diverted waste, including HHW, shipped from the Site.

Inspections

42. The Owner shall ensure that the following inspection schedule is adhered to:
- (a) on each operating day, an inspection of the working face and storage areas, daily compaction and cover of waste, signage, fencing and gate;
 - (b) on a monthly basis, an inspection of the areas under final cover, road condition, access road and adjacent property litter inspection; and
 - (c) on an annual basis, an inspection of the monitoring wells and a field survey of the limit of fill area.

13. The Owner shall:
- (a) develop and implement a preventative maintenance program for all on-site equipment associated with the processing and managing of waste materials. The preventative maintenance program shall be available on Site for inspection by a Provincial Officer upon request; and
 - (b) conduct regular inspections of equipment used in waste management activities to ensure they are in good working condition and operating in a manner that will not negatively impact the environment. Any deficiencies, that might negatively impact the environment detected during these regular inspections shall be promptly corrected.
14. The Owner shall keep a record of all inspections undertaken. The records shall be available on Site for inspection by a Provincial Officer, upon request.

Emergency Response Measures

15. Within ninety (90) days of issuing this Certificate, the Owner shall have in place an Emergency Response Plan for the operation of the Site. The Plan shall include, but is not limited to:
- (a) emergency response procedures to be undertaken in the event of a spill (including specific clean up methods), fire or medical emergency;
 - (b) a list of equipment and spill clean up materials;
 - (c) names and telephone numbers of resources available for emergency response; and
 - (d) a notification protocol with names and telephone numbers of persons to be contacted, including Owner's personnel, the Ministry Spills Action Centre and District Office and Fire Department.
16. A copy of the Emergency Response Plan shall be kept in a central location available to all staff and shall be made available for inspection by a Provincial Officer upon request.
17. The Owner shall ensure that:
- (a) the equipment and materials outlined in the Emergency Response Plan are in a good state of repair, fully operational and immediately available in each of the vehicles approved under this Certificate;
 - (b) all operating personnel are fully trained in the contingency equipment and materials' use and in the procedures to be employed in the event of an emergency; and
 - (c) the Emergency Response Plan is reviewed and updated on an annual basis as a minimum.

Training

18. (a) All attendants of the Site shall be trained, through instruction and practice, with respect to the following:
- (i) terms, conditions and operating requirements of this Certificate;

- (ii) operation and management of the Site, or area(s) within the Site including procedures for receiving or refusing waste, screening, handling and temporarily storing wastes;
 - (iii) shipping and manifesting procedures;
 - (iv) an outline of the responsibilities of Site personnel including roles and responsibilities during emergencies and spills;
 - (v) the Emergency Response Plan as required under Condition 45;
 - (vi) environmental, and occupational health and safety concerns pertaining to the wastes to be transferred;
 - (vii) emergency first-aid information;
 - (viii) relevant waste management legislation and regulations, including the Act and Ontario Regulation 347;
 - (ix) recording procedures as required under Conditions 30(c) and 41;
 - (x) equipment and site inspection procedures, as required under Conditions 42, 43 and 47;
 - (xi) nuisance control procedures, as required under Condition 40; and
 - (xii) procedures for recording and responding to public complaints.
- (b) The Owner shall maintain, and have available for inspection by a Provincial Officer upon request, a written record of the training provided including:
- (i) date of training;
 - (ii) name and signature of person who has been trained; and
 - (iii) description of the training provided.

Monitoring Program

49. (a) A groundwater, surface water and leachate monitoring program shall be carried out at the Site in accordance Schedule "B";
- (b) The monitoring program shall include surface water sampling of the North Saugeen River upstream and downstream of the Site; and
- (c) The Site monitoring program may be amended from time to time, as required, by the District Manager.

Annual Report

50. By March 31st of each year, the Owner shall submit an annual report on the operation, development and monitoring of the Site to the District Manager. The report shall cover the calendar year ending the preceding December 31 and shall include the following where applicable:
- (a) an updated site contour plan(s) showing areas that have been filled with waste, and areas to be filled with waste during the next reporting year;
 - (b) a summary of the number of truckloads and estimated quantities of waste received and landfilled, and the estimated quantity of cover materials used;
 - (c) an estimate of the remaining Site capacity and Site life;

- (d) an estimate of the amount of hazardous and non-hazardous waste diverted from landfill and the destination of diverted materials;
- (e) any operational or environmental problems encountered and any mitigative actions taken;
- (f) a plan of the Site outlining monitoring locations;
- (g) tables outlining monitoring locations, analytical parameters sampled, and sampling results;
- (h) an assessment of surface water quality in relation to the PWQO;
- (i) an assessment of groundwater quality in relation to the RUP;
- (j) conclusions of the monitoring data and a review of the adequacy of monitoring programs;
- (k) an assessment of the need for any remedial measures;
- (l) a summary of complaints made regarding Site operations, and their resolution;
- (m) the status of compliance with all Conditions of this Certificate;
- (n) recommendations for changes to the operation, development and monitoring of the Site;
- (o) any other information required under this Certificate or which the Director or District Manager may require from time to time.

SCHEDULE "A"

This Schedule "A" forms part of Certificate of Approval No. A272402.

1. Application for a Certificate of Approval for a Waste Disposal Site (Landfill), dated September 11, 1984.
2. Report prepared by Conestoga-Rovers & Assoc. Ltd. entitled "Operation and Management, Chesley Landfill Site", dated August 28, 1984.
3. Report prepared by Conestoga-Rovers & Assoc. Ltd. entitled "Hydrogeologic Investigation, Chesley Landfill Site", dated August 28, 1984.
4. "Plan of Survey of Lot 5 and Parts of King & Spring Streets, Registered Plan No. 236 and Part of Lot 28, Concession II, Town of Chesley, County of Bruce", registered as Plan 3-R-3609 on July 13, 1984.
5. Letter dated November 19, 1996, from P. Brodzikowski, P.Eng., Henderson, Paddon & Associates Limited, to A. Clark, MOEE Owen Sound, Re: Town of Chesley Landfill - Access Road Turnaround.
6. Letter dated August 14, 1997, from P. Brodzikowski, P. Eng., Henderson, Paddon & Associates, Limited, to P. Bye, MOEE Owen Sound, Re: Town of Chesley Landfill - Access Road Turnaround.
7. Plan of Survey of Part of Lot 28, Concession I, Geographic Township of Elderslie, Municipality of the Town of Chesley, County of Bruce, registered as Plan 3R-6697 on August 1, 1997.
8. Drawing No. 8673-96 entitled "Town of Chesley Landfill Site", March 1997, Existing Conditions", prepared by Henderson, Paddon & Associates Limited, dated April 27, 1997, which shows the "Municipally owned property for future road widening, turnaround and storage of recyclable material".
9. Letter dated February 23, 1998, from P. Brodzikowski, P.Eng., Henderson, Paddon & Associates Limited, to D. Hamilton, MOE Owen Sound Area Office, Re: Town of Chesley Landfill - Fill Beyond Approved Limit.
10. Letter from P. Brodzikowski, Henderson, Paddon Environmental Inc., to S. Ellis, MOE, dated March 6, 2000, providing additional information as requested.
11. Application for a Provisional Certificate of Approval for a Waste Disposal Site, signed by Ms. Joan Albright, CAO/Clerk, Municipality of Arran-Elderslie, dated April 22, 2004.
12. Drawing No. 8673-2003 entitled "Chesley Landfill Site, December 2003, Existing Conditions", prepared by Henderson Paddon & Associates Limited, dated February 2004.

13. Letter from P. Brodzikowski, Henderson, Paddon Environmental Inc., to EAAB, dated October 15, 2004, agreeing to changes in the design and operation of the HHW depot.

SCHEDULE "B"

This Schedule "B" forms part of Certificate of Approval No. A272402.

Groundwater Sampling

Location	Parameters	Frequency
OW1-83, OW2-83, OW3-83, OW4-83, TH1-81, TH2-81, TH4-81, TH8-81, TH2-02, TH4-02	calcium, magnesium, chloride, pH, phenols, nitrate, nitrite, TKN, total phosphorous, hardness, conductivity, ammonia, arsenic	Spring and fall
TH6-81	calcium, magnesium, chloride, pH, phenols, nitrate, nitrite, TKN, total phosphorous, hardness, conductivity, ammonia, arsenic sodium, potassium, alkalinity, sulphate, iron	Spring and fall

Surface Water Sampling

Location	Parameters	Frequency
SP2-85, SP2A-85, SP3-85, SP4-85, SP5-88, SS 1/99	calcium, magnesium, chloride, pH, hardness, conductivity, phenols, nitrate, nitrite, ammonia, TKN, total phosphorous, arsenic	Spring and fall
SP1-83	calcium, magnesium, chloride, pH, hardness, conductivity, phenols, nitrate, nitrite, ammonia, TKN, total phosphorous, arsenic, sodium, potassium, alkalinity, sulphate, iron	Spring and fall

Leachate Sampling

Location	Parameters	Frequency
MH7A, MH8	calcium, chloride, pH, hardness, conductivity, ammonia, TKN, total phosphorous, sodium, potassium, BOD, DOC, nitrate, nitrite, phenols, COD	Spring and fall

The reasons for the imposition of these terms and conditions are as follows:

The reason for Condition 1 is to clarify that the previously issued Certificate of Approval No. A272402 issued on March 7, 1985, as amended on June 7, 1991, January 30, 1998, May 25, 1998, and April 11, 2000, is no longer in effect and has been replaced and superseded by the Terms and Conditions stated in this Certificate.

The reason for Conditions 2, 21, 22, 23, 34, 44 and 50 is to ensure that this Site is developed and operated in accordance with the application submitted by the Owner, and not in a manner which the Director has not been asked to consider.

The reason for Conditions 3, 4, 5, 8, 9, 10, 11 and 12 is to clarify the legal responsibilities and obligations imposed by this Certificate.

The reason for Conditions 6 and 7 is to ensure that appropriate Ministry staff have ready access to the Site in order to confirm that the Site is being operated according to this Certificate. The condition is supplementary to the powers afforded a Provincial Officer pursuant to the Act, the OWRA, and the Pesticides Act, as amended.

The reason for Condition 13 is ensure that future owners of the Site are aware of the existence of, and the obligations placed by, this Certificate.

The reason for Condition 14 is that Section 46 of the Act prohibits any use being made of the lands after they cease to be used for waste disposal purposes within a period of twenty-five years from the year in which such land ceased to be used unless the approval of the Minister for the proposed use has been given. The purpose of this prohibition is to draw to the attention of future owners and occupants the potential for hazards which might occur as a result of waste being disposed of on the Site.

The reason for Conditions 15 and 35 is to ensure that only waste approved under this Certificate are received at the Site.

The reason for Conditions 16, 17, 19, 24, 25, 26, 40, 42 and 49 is to ensure that the Site is operated in a manner which does not result in a nuisance or a hazard to the health and safety of the environment or people.

The reason for Condition 18 and 37 is to ensure the Site is only operated in the presence of trained personnel and to ensure proper management of waste.

The reason for Condition 20 is to ensure that the Site is secure when unattended to prevent vandalism.

The reason for Conditions 27 and 28 is to ensure that the Site is closed in accordance with MOE standards and to protect the health and safety of the environment.

The reason for Conditions 30, 31, 32, 33, 36 and 38 is to ensure that waste storage is done in a manner and duration which does not result in a nuisance or a hazard to the health and safety of the environment or people.

The reason for Condition 43 is to ensure that all equipment and facilities are maintained in good working order.

The reason for Conditions 45, 46 and 47 is to ensure that the Owner is prepared and properly equipped to take action in the event of a spill, fire or other operational upset.

The reason for Condition 48 is to ensure that the Owner's staff are properly trained in the operation of the equipment used at the Site and emergency response procedures. This will minimize the possibility of spills occurring and will enable staff to deal promptly and effectively with any spills that do occur.

This Provisional Certificate of Approval revokes and replaces Certificate(s) of Approval No. A272402 issued on March 7, 1985 as amended by Notices issued June 7, 1991, January 30, 1998, May 25 1998, and April 11, 2000

In accordance with Section 139 of the Environmental Protection Act, R.S.O. 1990, Chapter E-19, as amended, you may by written notice served upon me and the Environmental Review Tribunal within 15 days after receipt of this Notice, require a hearing by the Tribunal. Section 142 of the Environmental Protection Act provides that the Notice requiring the hearing shall state:

**The portions of the approval or each term or condition in the approval in respect of which the hearing is required, and;
The grounds on which you intend to rely at the hearing in relation to each portion appealed.**

The Notice should also include:

**The name of the appellant;
The address of the appellant;
The Certificate of Approval number;
The date of the Certificate of Approval;
The name of the Director;
The municipality within which the waste disposal site is located;**

And the Notice should be signed and dated by the appellant.

This Notice must be served upon:

**Secretary*
Environmental Review Tribunal
1 Yonge St., 12th Floor
Box 2382
Toronto, Ontario
M4V 1L3**

AND

**The Director
Section 39, Environmental Protection Act
Ministry of Environment and Energy
2 St. Clair Avenue West, Floor 12A
Toronto, Ontario
M4V 1L3**

Further information on the Environmental Review Tribunal's requirements for an appeal can be obtained directly from

Telephone at: Tel: (416) 314-4600, Fax: (416) 314-4506 or www.ert.gov.on.ca

The above noted waste disposal site is approved under Section 39 of the Environmental Protection Act

DATED AT TORONTO this 3rd day of March, 2005

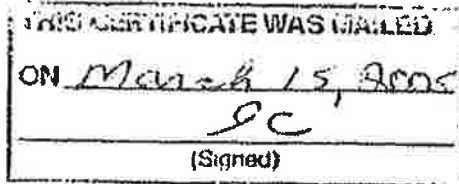

Ian Parrott, P.Eng.
Director
Section 39, *Environmental Protection Act*

VP/

xx District Manager, MOE Owen Sound
Peter Brodzikowski, P.Eng., Henderson Paddon & Associates Limited ✓

AMENDMENT TO PROVISIONAL CERTIFICATE OF
APPROVAL
WASTE DISPOSAL SITE
NUMBER A272402
Notice No. 1
Issue Date: September 8, 2011

RECEIVED
SEP 15 2011

The Corporation of the Municipality of Arran-Elderslie
1925 Bruce Road 10
Post Office Box, No. 70
Chesley, Ontario
N0G 1L0

Site Location: Chesley Landfill Site
Lot 28, Concession 1
Arran-Elderslie Municipality, County of Bruce

You are hereby notified that I have amended Provisional Certificate of Approval No. A272402 issued on March 3, 2005 for the use and operation of a 2.4 hectare landfilling and ancillary waste diversion activities, within a total site area of 6.4 hectares, as follows:

Condition 49 and Schedule "B" are hereby revoked.

The following conditions are added to the Certificate.

Monitoring Program

49. LANDFILL MONITORING

Landfill Gas

- (1) The *Owner* shall ensure that any buildings or structures at the *Site* contain adequate ventilation systems to relieve any possible landfill gas accumulation. Routine monitoring for explosive methane gas levels shall be conducted in all buildings or structures at the *Site*, especially enclosed structures which at times are occupied by people.

Compliance

- (2) The *Site* shall be operated in such a way as to ensure compliance with the following:

- (a) Reasonable Use Guideline B-7 for the protection of the groundwater at the *Site*; and
- (b) Provincial Water Quality Objectives included in the July 1994 publication entitled *Water Management Policies, Guidelines, Provincial Water Quality Objectives*, as amended from time to time or limits set by the *Regional Director*, for the protection of the surface water at and off the *Site*.

Surface Water and Ground Water

- (3) The *Owner* shall monitor surface water and ground water in accordance with the monitoring programs outlined in documents listed in the attached Schedule "A".
- (4) A certified Professional Geoscientist or Engineer possessing appropriate hydrogeologic training and experience shall execute or directly supervise the execution of the groundwater monitoring and reporting program.

Groundwater Wells and Monitors

- (5) The *Owner* shall ensure that all groundwater monitoring wells which form part of the monitoring program are properly capped, locked and protected from damage.
- (6) Where landfilling is to proceed around monitoring wells, suitable extensions shall be added to the wells and the wells shall be properly re-secured.
- (7) Any groundwater monitoring well included in the on-going monitoring program that are damaged shall be assessed, repaired, replaced or decommissioned by the *Owner*, as required.
 - (a) The *Owner* shall repair or replace any monitoring well which is destroyed or in any way made to be inoperable for sampling such that no more than one regular sampling event is missed.
 - (b) All monitoring wells which are no longer required as part of the groundwater monitoring program, and have been approved by the *Director* for abandonment, shall be decommissioned by the *Owner*, as required, in accordance with *O.Reg. 903*, that will prevent contamination through the abandoned well. A report on the decommissioning of the well shall be included in the Annual Report for the period during which the well was decommissioned.

Trigger Mechanisms and Contingency Plans

- (8) (a) Trigger mechanisms shall be in accordance with the documents in Schedule "A".
 - (b) Contingency plan in the event of a confirmed exceedence of a site-specific trigger

level relating to leachate mounding or groundwater or surface water impacts due to leachate shall be in accordance with documents in Schedule "A".

- (9) In the event of a confirmed exceedence of a site-specific trigger level relating to leachate mounding or groundwater or surface water impacts due to leachate, the *Owner* shall immediately notify the *District Manager*, and an investigation into the cause and the need for implementation of remedial or contingency actions shall be carried out by the *Owner* in accordance with the approved trigger mechanisms and associated contingency plans.
- (10) If monitoring results, investigative activities and/or trigger mechanisms indicate the need to implement contingency measures, the *Owner* shall ensure that the following steps are taken:
 - (a) The *Owner* shall notify the *District Manager*, in writing of the need to implement contingency measures, no later than 30 days after confirmation of the exceedences;
 - (b) Detailed plans, specifications and descriptions for the design, operation and maintenance of the contingency measures shall be prepared and submitted by the *Owner* to the *District Manager* for approval; and
 - (c) The contingency measures shall be implemented by the *Owner* upon approval by the *District Manager*.
- (11) The *Owner* shall ensure that any proposed changes to the site-specific trigger levels for leachate impacts to the surface water or groundwater, are approved in advance by the *Director* via an amendment to this *Certificate*.

Changes to the Monitoring Plan

- (12) The *Owner* may request to make changes to the monitoring program(s) to the *District Manager* in accordance with the recommendations of the annual report. The *Owner* shall make clear reference to the proposed changes in separate letter that shall accompany the annual report.
- (13) Within fourteen (14) days of receiving the written correspondence from the *District Manager* confirming that the *District Manager* is in agreement with the proposed changes to the environmental monitoring program, the *Owner* shall forward a letter identifying the proposed changes and a copy of the correspondences from the *District Manager* and all other correspondences and responses related to the changes to the monitoring program, to the *Director* requesting the *Certificate* be amended to approve the proposed changes to the environmental monitoring plan prior to implementation.
- (14) In the event any other changes to the environmental monitoring program are proposed outside of the recommendation of the annual report, the *Owner* shall follow current ministry procedures for seeking approval for amending the *Certificate*.

51. CLOSURE PLAN

- (1) The Closure Plan for the Landfill dated October 2010 is hereby approved. No waste shall be deposited after reaching the final waste contours approved by the *Director*.
- (2) The Landfill shall be closed in accordance with the Closure Plan approved by the *Director*.

The following documents are added to the Schedule "A":

14. The Report titled "Chesley Landfill, Project No. 081-12460-00, Final Closure Plan" dated October 2010 and prepared by GENIVAR Consultants L.P.
15. Electronic mail dated August 26, 2011 from Brad Benson, Genivar Consultants LP, to Ranjani Munasinghe, Ministry of the Environment.

The reasons for this amendment to the Certificate of Approval are as follows:

1. Condition 49 and Schedule "B" were revoked to update the content of these two items to current standards.
2. Reasons for Condition 49(1) are to ensure that off-site migration of landfill gas is monitored and all buildings at the *Site* are free of any landfill gas accumulation, which due to a methane gas component may be explosive and thus create a danger to any persons at the *Site*.
3. Condition 49(2) is included to provide the groundwater and surface water limits to prevent water pollution at the *Site*.
4. Conditions 49(3) and 49(4) are included to require the *Owner* to demonstrate that the *Site* is performing as designed and the impacts on the natural environment are acceptable. Regular monitoring allows for the analysis of trends over time and ensures that there is an early warning of potential problems so that any necessary remedial/contingency action can be taken.
5. Conditions 49(5), 49(6) and 49(7) are included to ensure the integrity of the groundwater monitoring network so that accurate monitoring results are achieved and the natural environment is protected.
6. Conditions 49(8) to 49(11) inclusive are added to ensure the *Owner* has a plan with an organized set of procedures for identifying and responding to potential issues relating to groundwater and surface water contamination at the *Site's* compliance point.
7. Conditions 49(12), 49(13) and 49(14) are included to streamline the approval of the changes to the monitoring plan.
8. The reasons for Condition 51 are to ensure that final closure of the *Site* is completed in an

aesthetically pleasing manner, in accordance with Ministry standards, and to ensure the long-term protection of the health and safety of the public and the environment.

This Notice shall constitute part of the approval issued under Provisional Certificate of Approval No. A272402 dated March 3, 2005 as amended.

In accordance with Section 139 of the Environmental Protection Act, R.S.O. 1990, Chapter E-19, as amended, you may by written notice served upon me and the Environmental Review Tribunal within 15 days after receipt of this Notice, require a hearing by the Tribunal. Section 142 of the Environmental Protection Act, provides that the Notice requiring the hearing shall state:

1. The portions of the approval or each term or condition in the approval in respect of which the hearing is required; and
2. The grounds on which you intend to rely at the hearing in relation to each portion appealed.

The Notice should also include:

3. The name of the appellant;
4. The address of the appellant;
5. The Certificate of Approval number;
6. The date of the Certificate of Approval;
7. The name of the Director;
8. The municipality within which the waste disposal site is located;

And the Notice should be signed and dated by the appellant.

This Notice must be served upon:

The Secretary*
Environmental Review Tribunal
655 Bay Street, 15th Floor
Toronto, Ontario
M5G 1E5

AND

The Director
Section 39, *Environmental Protection Act*
Ministry of the Environment
2 St. Clair Avenue West, Floor 12A
Toronto, Ontario
M4V 1L5

* Further information on the Environmental Review Tribunal's requirements for an appeal can be obtained directly from the Tribunal at: Tel: (416) 314-4600, Fax: (416) 314-4506 or www.ert.gov.on.ca

The above noted waste disposal site is approved under Section 39 of the Environmental Protection Act.

DATED AT TORONTO this 8th day of September, 2011

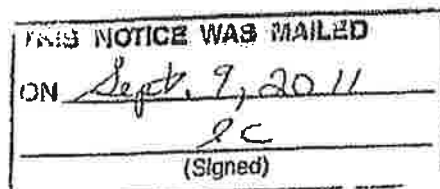



Tesfaye Gebrezghi, P.Eng.
Director
Section 39, *Environmental Protection Act*

RM/

c: District Manager, MOE Owen Sound
Peter Brodzikowski, P. Eng., GENIVAR ✓

CONTENT COPY OF ORIGINAL



Ontario

Ministry
of the
Environment

Ministère
de
l'Environnement

AMENDMENT TO PROVISIONAL CERTIFICATE OF APPROVAL
WASTE DISPOSAL SITE
NUMBER A272402
Notice No. 1

Municipality of Arran-Elderslie
P.O. Box 70, 1925 County Road #10
Arran-Elderslie, Ontario
N0G 1L0

Site Location: Part of Lot 5, Part of Lot 28,, Concession 2,
Parts of King and Spring Streets and
Part of Lot 28, Concession 1, former Town of Chesley
Municipality of Arran-Elderslie, County Of Bruce

You are hereby notified that I have amended Provisional Certificate of Approval No. A272402 issued on March 7, 1985, as amended June 7, 1991, January 30, 1998 and May 21, 1998 for a 2.4 hectare landfill site within a total area of 6.4 hectares, as follows:

1. For the purpose of this Notice, the following definitions are added:

"Director" means a Director, Environmental Assessment and Approvals Branch of the Ontario Ministry of the Environment;

"District Manager" means the District Manager of the Barrie District Office, Southwestern Region of the Ontario Ministry of the Environment;

"interim closure" means an extended period of time during which the Site is not actively operating but is not recognized as permanently closed;

"municipal waste" means municipal waste as defined in Ontario Regulation 347, R.R.O. 1990;

"Owner" means the Corporation of the Municipality of Arran-Elderslie, including its officers, employees, agents or contractors.

2. The following Conditions are hereby added:

12. The Site shall accept only municipal waste generated within the geographic area of the Municipality of Arran-Elderslie.
13. The Site monitoring program may be amended from time to time, as required, by the District Manager.
14. Two (2) years prior to the time the Site reaches its approved capacity of the Site, the Owner shall submit to the Director for approval, a detailed Site closure plan which includes but is not limited to the following: post-closure inspection procedures and schedule, maintenance and monitoring plan, and proposed end use of the Site.
15. Six (6) months prior to interim closure of the Site, the Owner shall submit to the District Manager for approval, a detailed interim Site closure plan which includes but is not limited to the following: schedule and plans for Site inspections, maintenance and monitoring, and details regarding interim cover and Site security. The Site shall not be closed in the interim unless in accordance with an approved interim closure plan.

3. Condition 2 is hereby revoked and replaced by the following:

CONTENT COPY OF ORIGINAL

2. The Owner shall submit an annual report on the operation, development and monitoring of the Site to the District Manager by March 31 of each year. The report shall cover the calendar year ending the preceding December 31 and shall include the following, where applicable:
 - (a) an updated site contour plan(s) showing areas that have been filled with waste, and areas to be filled with waste during the next reporting year;
 - (b) a summary of the number of truckloads and estimated quantities of waste received, landfilled, and the estimated quantity of cover materials used;
 - (c) an estimate of the remaining Site capacity and Site life;
 - (d) any operational or environmental problems encountered and any mitigative actions taken;
 - (e) the data and interpretive analyses of the data from all monitoring programs;
 - (f) an assessment of the need for any remedial measures;
 - (g) the status of compliance with all Conditions of Provisional Certificate of Approval number A272402;
 - (h) recommendations for changes to the operation, development and monitoring of the Site;
 - (i) any other information required under this Certificate or which the Director or the District Manager may require from time to time.

The following documents are hereby added to *Schedule "A"*:

10. Application for Approval of a Waste Disposal Site, dated February 15, 2000, from the Corporation of the Municipality of Arran-Elderslie and supporting information.
11. Letter from S. Ellis, MOE, to J. Albright, Municipality of Arran-Elderslie, dated February 28, 2000, requesting additional information.
12. Letter from P. Brodzikowski, Henderson, Paddon Environmental Inc., to S. Ellis, MOE, dated March 6, 2000, providing additional information as requested.

The reasons for these amendments to the Certificate of Approval are as follows:

1. The reason for Amendment 1 is to define terms used in the Certificate.
2. The reason for Conditions 2, 11, 12, 13, and 14 is to upgrade the existing Certificate to current MOE standards.
3. The reason for Condition 10 is to permit the Site to receive municipal waste from within the new geographic boundaries of the new municipality at the request of the municipality.
4. The reason for Condition 15 is to ensure the MOE is aware of any proposed interim closure of the Site and the Site is closed on an interim basis in such a manner as to prevent nuisance and adverse environmental and public health and safety effects.

This Notice shall constitute part of the approval issued under Provisional Certificate of Approval No.A272402 dated March 7, 1985 and as amended June 7, 1991, January 30, 1998 and May 21, 1998.

In accordance with Section 139 of the Environmental Protection Act, R.S.O. 1990, Chapter E-19, as amended, you may by written notice served upon me and the Environmental Appeal Board within 15 days after receipt of this Notice, require a hearing by the Board. Section 142 of the Environmental Protection Act, provides that the Notice requiring the hearing shall state:

1. The portions of the approval or each term or condition in the approval in respect of which the hearing is required, and;
2. The grounds on which you intend to rely at the hearing in relation to each portion appealed.

The Notice should also include:

3. The name of the appellant;
4. The address of the appellant;
5. The Certificate of Approval number;
6. The date of the Certificate of Approval;

CONTENT COPY OF ORIGINAL

7. The name of the Director;
8. The municipality within which the waste disposal site is located;

And the Notice should be signed and dated by the appellant.

This Notice must be served upon:

The Secretary*
Environmental Appeal Board
2300 Yonge St., 12th Floor
P.O. Box 2382
Toronto, Ontario
M4P 1E4

AND

The Director
Section 39, *Environmental Protection Act*
Ministry of the Environment
2 St. Clair Avenue West, Floor 12A
Toronto, Ontario
M4V 1L5

*** Further information on the Environmental Appeal Board's requirements for an appeal can be obtained directly from the Board at: Tel: (416) 314-4600, Fax: (416) 314-4506 or www.ert.gov.on.ca**

The above noted waste disposal site is approved under Section 39 of the Environmental Protection Act.

DATED AT TORONTO this 11th day of April, 2000

Andrzej Dominski, P.Eng.
Director
Section 39, *Environmental Protection Act*

SE/

c: District Manager, MOE Owen Sound

**APPENDIX B:
AVAILABLE TESTHOLE INFORMATION, WELL CONSTRUCTION
DETAILS & CROSS-SECTIONS (WSP, MARCH 2019)**

C:\19861\86731\WSP\000\FIG 7.1.dwg, Mar 07, 2019 - 1:43pm

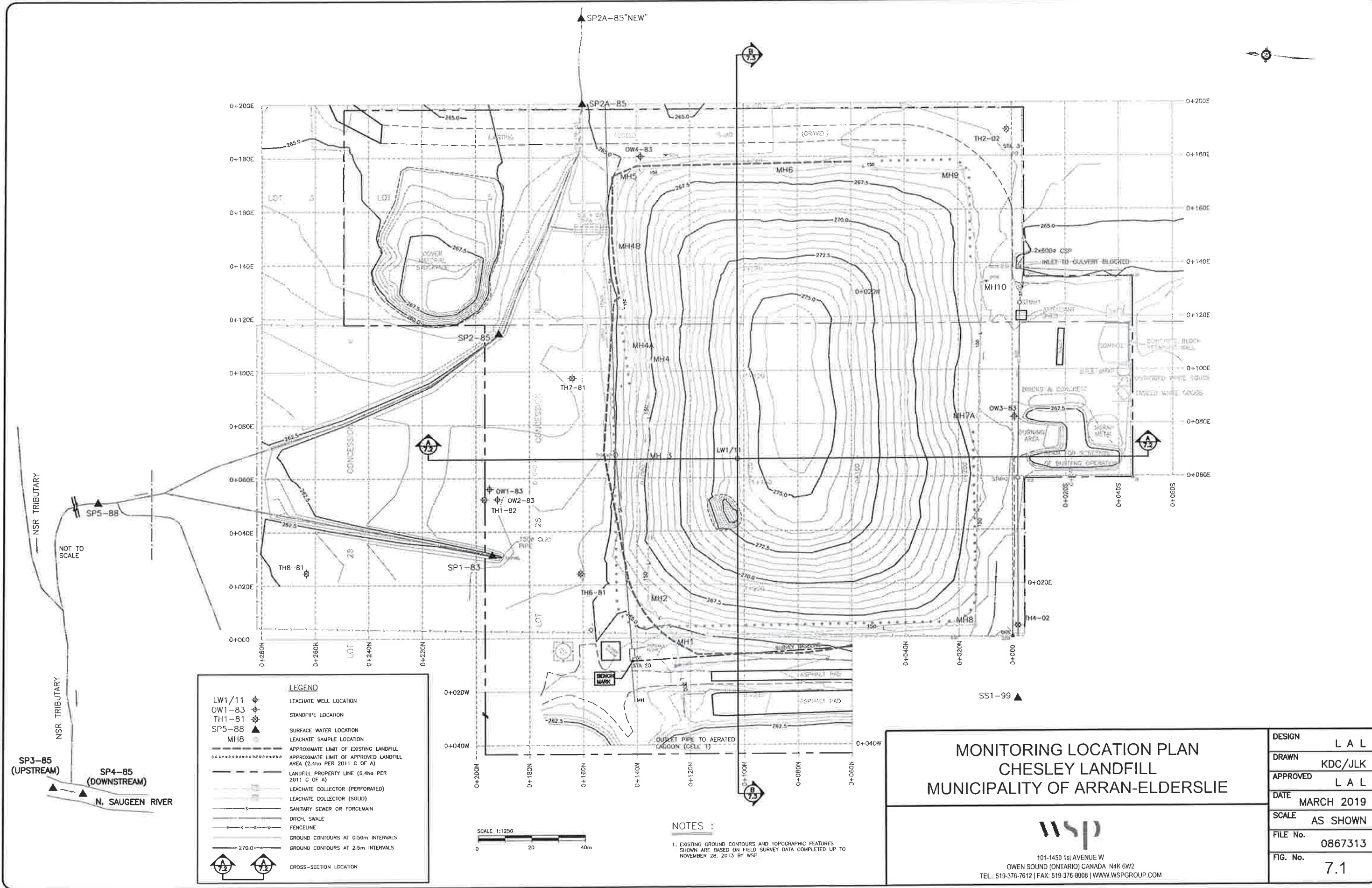

LEGEND	
LW1/11	LEACHATE WELL LOCATION
OW1-83	STANDPIPE LOCATION
TH1-81	STANDPIPE LOCATION
SP5-88	SURFACE WATER LOCATION
MH8	LEACHATE SAMPLE LOCATION
-----	APPROXIMATE LIMIT OF EXISTING LANDFILL AREA (2.4ha PER 2011 C OF A)
-----	APPROXIMATE LIMIT OF APPROVED LANDFILL AREA (2.4ha PER 2011 C OF A)
-----	LANDFILL PROPERTY LINE (6.4ha PER 2011 C OF A)
-----	LEACHATE COLLECTOR (PERFORATED)
-----	LEACHATE COLLECTOR (SOLID)
-----	SANITARY SEWER OR FORCEMAIN
-----	DITCH, SWALE
-----	FENCELINE
-----	GROUND CONTOURS AT 0.50m INTERVALS
-----	GROUND CONTOURS AT 2.5m INTERVALS
-----	CROSS-SECTION LOCATION



NOTES:
1. EXISTING GROUND CONTOURS AND TOPOGRAPHIC FEATURES SHOWN ARE BASED ON FIELD SURVEY DATA COMPLETED UP TO NOVEMBER 28, 2013 BY WSP

**MONITORING LOCATION PLAN
CHESLEY LANDFILL
MUNICIPALITY OF ARRAN-ELDERSLIE**

wsp
101-1450 1st AVENUE W
OWEN SOUND (ONTARIO) CANADA N4K 6W2
TEL: 519-376-7612 | FAX: 519-376-8008 | WWW.WSPGROUP.COM



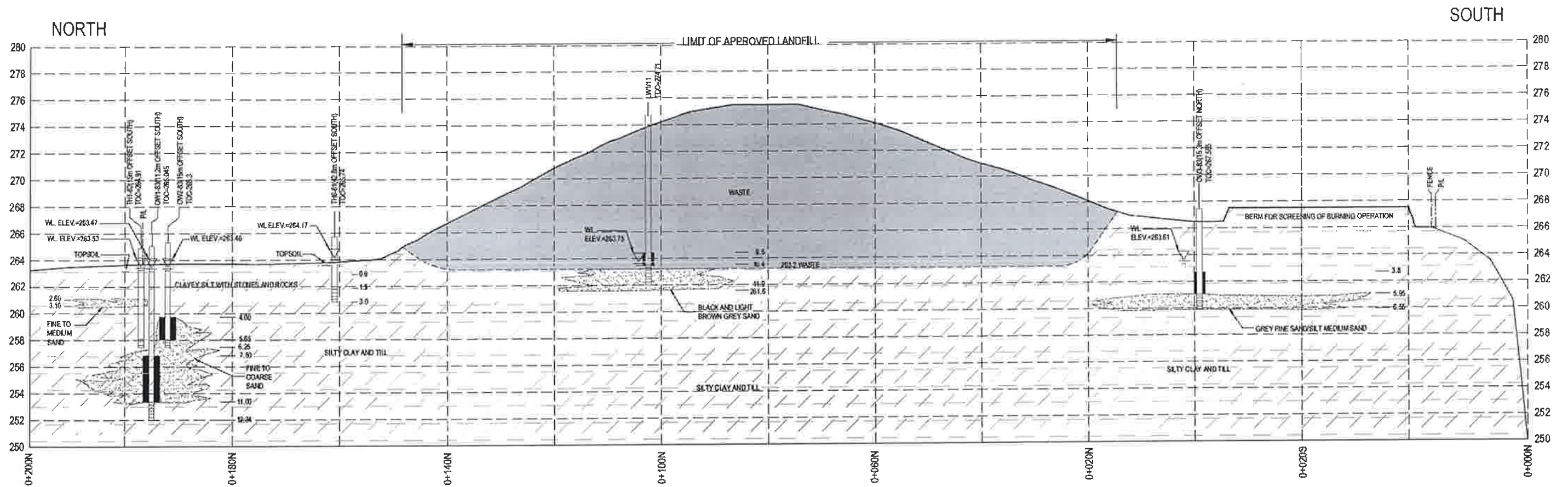





DESIGN	L A L
DRAWN	KDC/JLK
APPROVED	L A L
DATE	MARCH 2019
SCALE	AS SHOWN
FILE No.	0867313
FIG. No.	7.1



SECTION A - A'

SCALES :
 1 : 750 HORIZONTAL
 3X VERTICAL

LEGEND :

-  WASTE
-  SAND
-  SILT
-  CLAY
-  STATIC WATER LEVEL (MAY 15, 2018)
-  PIEZOMETRIC SURFACE (INTERPOLATED)
-  INFERRED SOIL BOUNDARY
-  2.60 ALL ELEVATIONS IN METRES GEODETIC

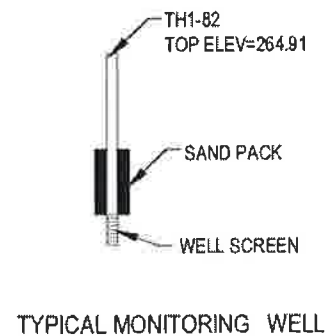

NOTES :

1. FOR LOCATION OF SECTION AND A-A' SEE FIGURE 7.1.
2. GROUNDWATER PROFILE SHOWN ON SECTIONS IS BASED ON MONITORING DATA OBTAINED BY WSP ON MAY 15, 2018.
3. CROSS-SECTION BASED ON WELL LOGS PREPARED BY CRA 1981, 1982, 1983 AND WSP 2011 (APPENDIX E).
4. EXISTING GROUND CONTOURS AND TOPOGRAPHIC FEATURES SHOWN ARE BASED ON FIELD SURVEY DATA COMPLETED UP TO NOVEMBER 28, 2013 BY WSP.
5. WASTE LIMITS ARE APPROXIMATE ONLY.
6. ALL ELEVATIONS METRES GEODETIC.

CROSS-SECTION A-A'
CHESLEY LANDFILL
MUNICIPALITY OF ARRAN-ELDERSLIE





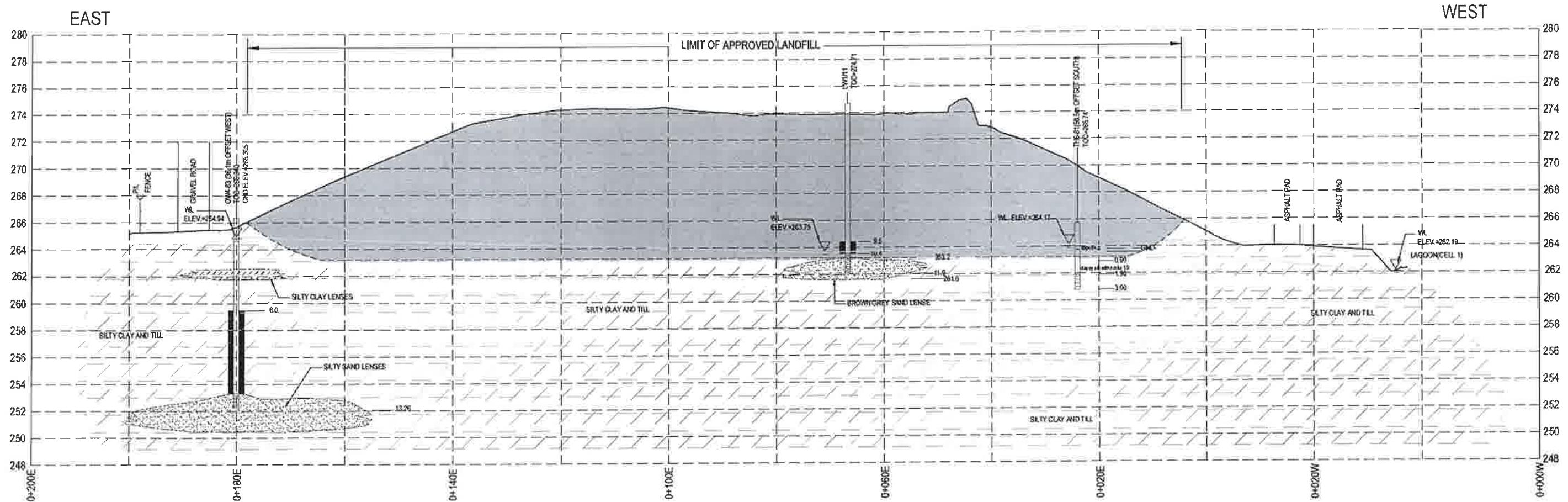

101-1450 1st AVENUE W
 OWEN SOUND (ONTARIO) CANADA N4K 6W2
 TEL: 519-376-7612 | FAX: 519-376-8008 | WWW.WSPGROUP.COM





DESIGN	L A L
DRAWN	JLK/JDG
APPROVED	L A L
DATE	MARCH 2019
SCALE	AS SHOWN
FILE No.	0867313
FIG. No.	7.2



SECTION B - B'

LEGEND :

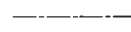
-  WASTE
-  SAND
-  SILT
-  CLAY

-  STATIC WATER LEVEL (MAY 15, 2018)
-  PIEZOMETRIC SURFACE (INTERPOLATED)
-  INFERRED SOIL BOUNDARY
-  2.60 ALL ELEVATIONS IN METRES GEODETIC

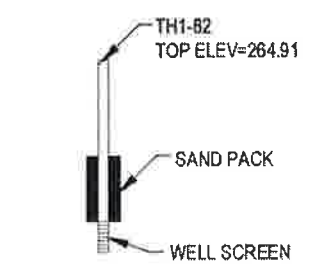

TYPICAL MONITORING WELL

SCALES :
1 : 750 HORIZONTAL
3X VERTICAL

NOTES :

1. FOR LOCATION OF SECTION AND B-B' SEE FIGURE 7.1.
2. GROUNDWATER PROFILE SHOWN ON SECTIONS IS BASED ON MONITORING DATA OBTAINED BY WSP ON MAY 29, 2018.
3. CROSS-SECTION BASED ON WELL LOGS PREPARED BY CRA 1981, 1982, 1983 AND WSP 2011 (APPENDIX E).
4. EXISTING GROUND CONTOURS AND TOPOGRAPHIC FEATURES SHOWN ARE BASED ON FIELD SURVEY DATA COMPLETED UP TO NOVEMBER 28, 2013 BY WSP.
5. WASTE LIMITS ARE APPROXIMATE ONLY.
6. ALL ELEVATIONS METRES GEODETIC.

<p>CROSS-SECTION B-B' CHESLEY LANDFILL MUNICIPALITY OF ARRAN-ELDERSLIE</p>  <p>101-1450 1st AVENUE W OWEN SOUND (ONTARIO) CANADA N4K 6W2 TEL.: 519-376-7612 FAX: 519-376-8008 WWW.WSPGROUP.COM</p>	DESIGN	L A L
	DRAWN	JLK/JDG
APPROVED	L A L	
DATE	MARCH 2019	
SCALE	AS SHOWN	
FILE No.	0867313	
FIG No.	7.3	

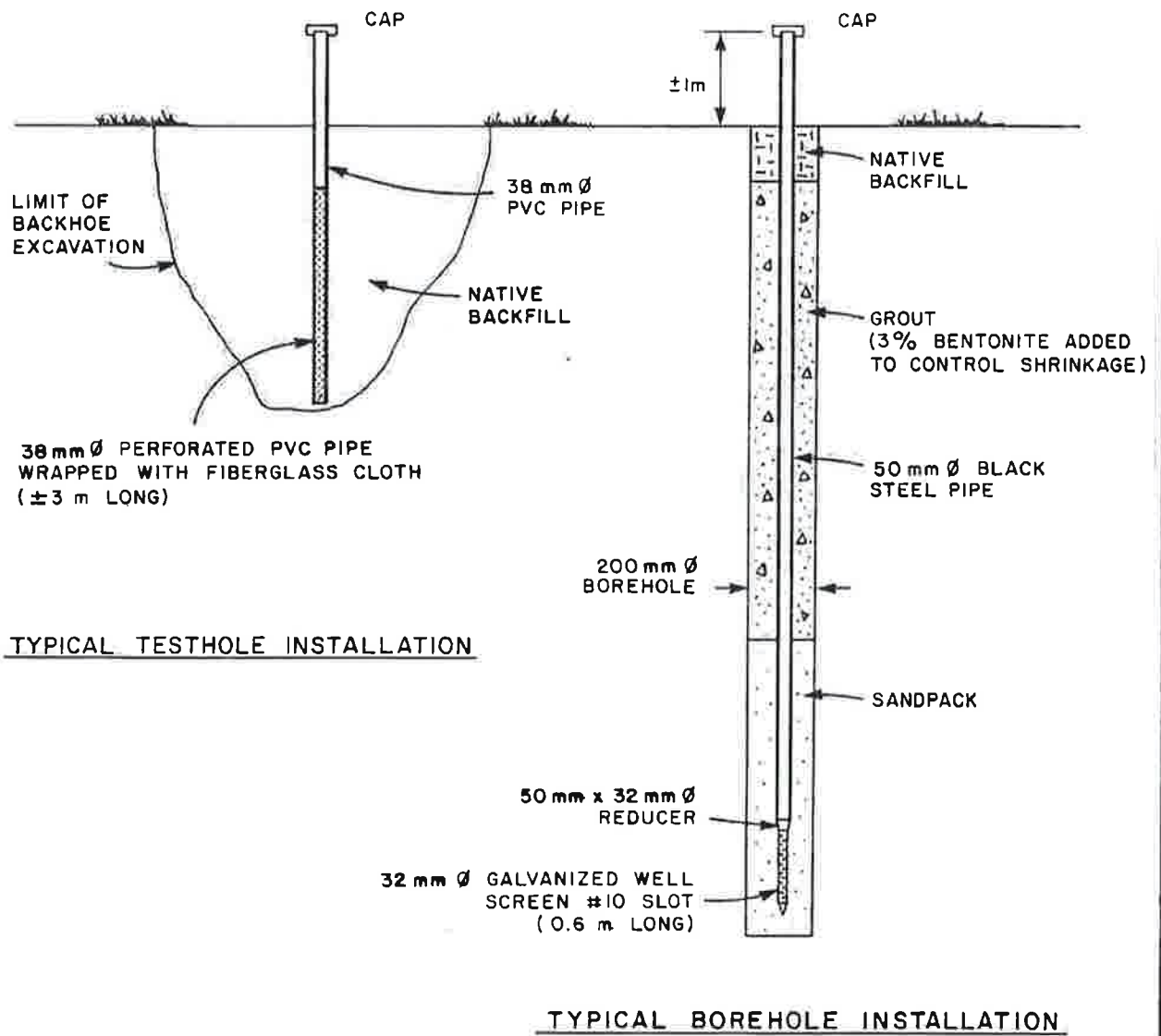

figure 4
 TYPICAL GROUNDWATER MONITORING
 WELL INSTALLATION DETAIL
Chesley Landfill Site

TABLE 2
 TESTHOLE LOGS
 SOILS INVESTIGATION
SEPTEMBER 16, 1981

<u>TESTHOLE NO.</u>	<u>DEPTH (m)</u>		<u>DESCRIPTION</u>	<u>WATER FOUND</u>
	<u>FROM</u>	<u>TO</u>		
TH1-81	0	0.7	Sandy fill with wood, brick and concrete rubble	0.7 m
	0.7	3.3	Clayey silt	
TH2-81	0	0.1	Topsoil	1.5 m
	0.1	0.8	Sand with stones and gravel	
	0.8	3.4	Clayey silt	
TH3-81	0	0.3	Topsoil	1.1 m
	0.3	1.1	Medium sand	
	1.1	1.9	Clayey silt with some sand	
	1.9	2.8	Clayey silt	
TH4-81	0	0.8	Sand with gravel and rocks	Not Found
	0.8	2.1	Clayey silt	
	2.1	3.1	Clayey silt with sand lenses	
TH5-81	0	0.3	Topsoil	1.8 m
	0.3	1.3	Clayey silt	
	1.3	1.8	Clayey silt with rocks	
	1.8	2.3	Silty sand with gravel	
TH6-81	0	0.2	Topsoil	Not Found
	0.2	0.9	Silty clay	
	0.9	1.9	Clayey silt with rocks	
	1.9	3.0	silty till	
TH7-81	0	0.1	Topsoil	Not Found
	0.1	0.7	Medium sand with gravel	
	0.7	3.2	Clayey silt	
	3.2	3.5	Clayey silt with stones	
TH8-81	0	0.1	Topsoil	1.0 m
	0.1	1.0	Silty sand with gravel and rocks	
	1.0	3.4	Clayey silt with stones and rocks	
<u>MAY 13, 1982</u>				
TH1-82	0	0.5	Topsoil	2.6 m
	0.5	2.6	Clayey silt with stones and rocks	
	2.6	3.1	Fine to medium sand with thin beds of silty fine sand	

STRATIGRAPHIC AND INSTRUMENTATION LOG

PROJECT NAME: CHESLEY LANDFILL SITE
 JOB NO: 9-847
 CLIENT: TOWN OF CHESLEY
 HOLE TYPE: 200 mm DIA. HOLLOW STEM AUGERS
 LOCATION: NORTH OF LANDFILL

HOLE NO: OW1-83 Page 1 of 2
 DATE COMPLETED: JUNE 17, 1983
 GEOLOGIST/ENGINEER: J. KAY
 GROUND ELEVATION: 264.025 m AMSL
 TOP OF PIPE ELEVATION: 265.045 m AMSL

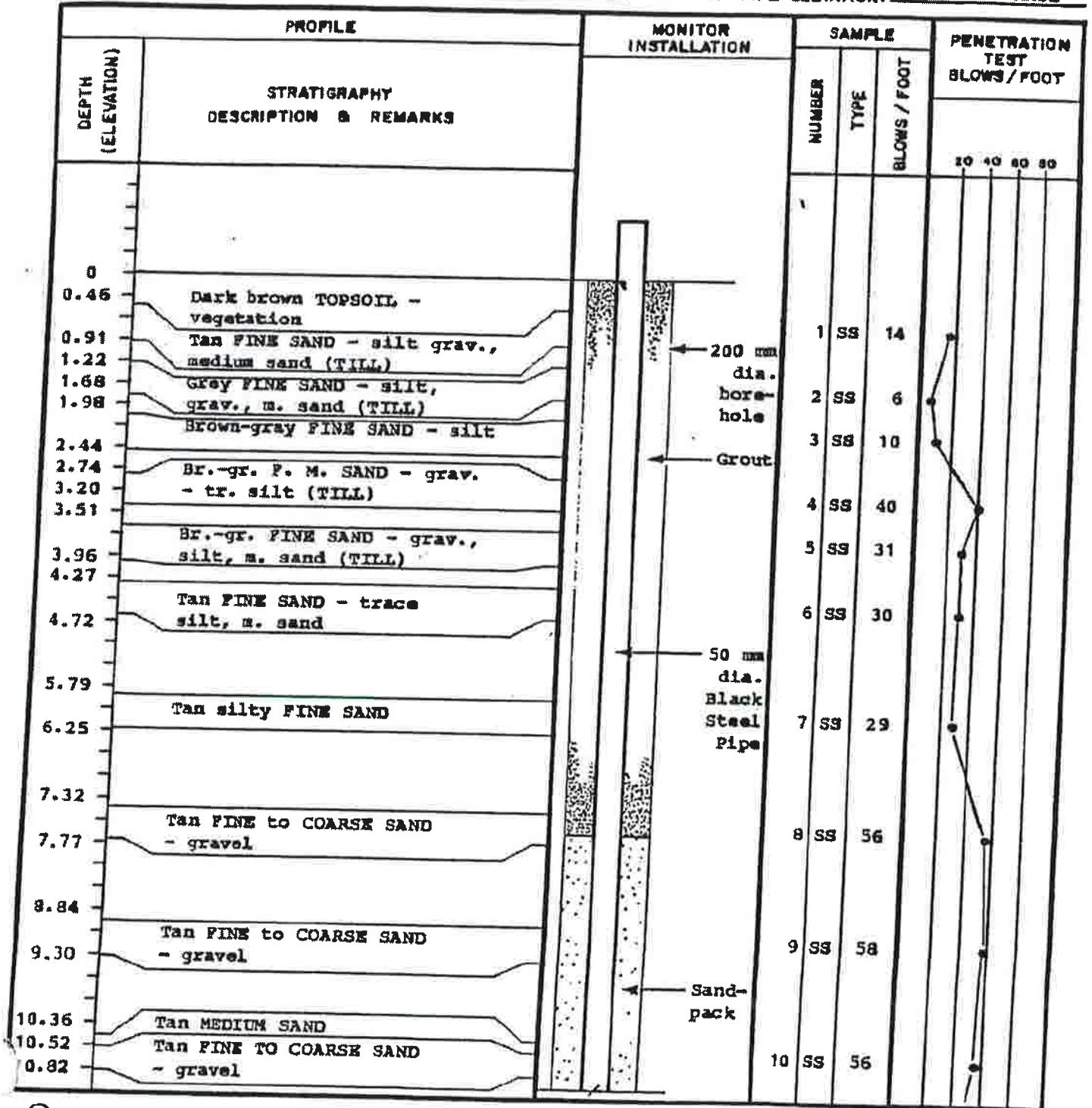

○ GRAIN SIZE ANALYSIS ▼ WATER FOUND ▽ STATIC WATER LEVEL

STRATIGRAPHIC AND INSTRUMENTATION LOG

PROJECT NAME: CHESLEY LANDFILL SITE

HOLE NO: OW1-83 Page 2 of 2

JOB NO: 9-847

DATE COMPLETED: JUNE 17, 1983

CLIENT: TOWN OF CHESLEY

GEOLOGIST/ENGINEER: J. KAY

HOLE TYPE: 200 mm DIA. HOLLOW STEM AUGERS

GROUND ELEVATION: 264.025 m AMSL

LOCATION: NORTH OF LANDFILL

TOP OF PIPE ELEVATION: 265.045 m AMSL

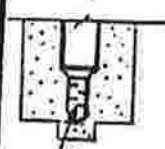
DEPTH (ELEVATION)	PROFILE STRATIGRAPHY DESCRIPTION & REMARKS	MONITOR INSTALLATION	SAMPLE			PENETRATION TEST BLOWS/FOOT			
			NUMBER	TYPE	BLOWS / FOOT	20	40	60	80
11.89 12.04 12.34	<div style="border: 1px solid black; padding: 5px; margin-bottom: 5px;">Tan FINE to MEDIUM SAND</div> <div style="border: 1px solid black; padding: 5px;">Tan MED. to COARSE SAND & GRAVEL</div>	Sandpack  32 mm dia. galvanized redhead wall screen (600 mm x 760 mm) (#10 slot) Total length 13.05 m pipe, screen & adaptor	11	SS	48				

GRAIN SIZE ANALYSIS
 WATER FOUND
 STATIC WATER LEVEL

STRATIGRAPHIC AND INSTRUMENTATION LOG

PROJECT NAME: CHESLEY LANDFILL SITE
 JOB N°: 9-847
 CLIENT: TOWN OF CHESLEY
 HOLE TYPE: 200 mm DIA. HOLLOW STEM AUGERS
 LOCATION: 5.0 METERS WEST OF OW1-83

HOLE N°: OW2-83
 DATE COMPLETED: JUNE 17, 1983
 GEOLOGIST/ENGINEER: J. KAY
 GROUND ELEVATION: 264.370 m AMSL
 TOP OF PIPE ELEVATION: 265.310 m AMSL

DEPTH (ELEVATION)	PROFILE	MONITOR INSTALLATION	SAMPLE		PENETRATION TEST BLOWS / FOOT								
	STRATIGRAPHY DESCRIPTION & REMARKS		NUMBER	TYPE	BLOWS / FOOT	BLOWS / FOOT							
						20	40	60	80				
0													
0.46	Dark brown TOPSOIL - veg.												
0.91	Tan F. SAND - silt, gr., m. sand (TILL)												
1.22													
1.68	Gray F. SAND - silt, grav., m. sand (TILL)												
1.98													
2.44	Brown-gray FINE SAND - silt												
2.74													
3.20	Br.-gr. F.-M. SAND - grav., - tr. silt (TILL)												
3.51													
3.96	Br.-gr. F. SAND - grav., silt, m. sand (TILL)												
4.27													
4.72	Tan F. SAND - tr. silt, m. sand												
5.79													
6.25	Tan silty FINE SAND												

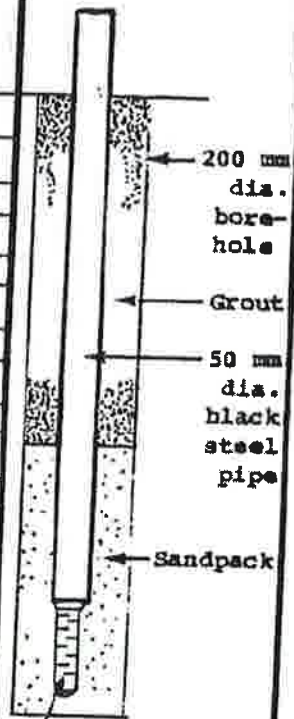

32 mm dia. gal-
vanized redhead
well screen
(600 x 760 mm)
(#10 slot)

Note - Stratigraphic
Information taken from
OW1-83

Total length
7.52 m pipe,
screen & adaptor

○ GRAIN SIZE ANALYSIS ▼ WATER FOUND ▽ STATIC WATER LEVEL

STRATIGRAPHIC AND INSTRUMENTATION LOG

PROJECT NAME: CHESLEY LANDFILL SITE

HOLE NO: OW3-83

JOB NO: 9-847

DATE COMPLETED: JUNE 17, 1983

CLIENT: TOWN OF CHESLEY

GEOLOGIST/ENGINEER: J. KAY

HOLE TYPE: 200 mm DIA. HOLLOW STEM AUGERS

GROUND ELEVATION: 266.620 m AMSL

LOCATION: SOUTH OF LANDFILL

TOP OF PIPE ELEVATION: 267.555 m AMSL

DEPTH (ELEVATION)	PROFILE STRATIGRAPHY DESCRIPTION & REMARKS	MONITOR INSTALLATION	SAMPLE		PENETRATION TEST BLOWS / FOOT								
			NUMBER	TYPE	BLOWS / FOOT	20 40 60 80							
0													
0.76													
1.22	Mottled brown & gray CLAY - silt	<p>200 mm dia. borehole</p> <p>50 mm dia. black steel pipe</p> <p>Grout</p> <p>Sandpack</p> <p>32 mm galvanized redhead well screen (600 x 760 mm) (#10 slot)</p> <p>Total length 7.54 m pipe, screen & adaptor</p>	1	SS	19								
1.52	Brown silty CLAY		2	SS	12								
1.98	Gr.-br. alternating f. sandy		3	SS	10								
2.29	SILT & silty CLAY tr. - f.		4	SS	29								
2.74	m. sand lenses		5	SS	42								
3.05	Grey SILT - f. sand, grav. (TILL)		6	SS	54								
3.51	Grey SILT - f. sand, grav. (TILL)		7	SS	14								
3.81	Grey f. sandy SILT - grav. (TILL)												
4.27	Grey f. SAND - silt m. sand												
4.57	Gr. br. silty CLAY - f. sand lenses												
5.21													
6.10													
6.40													
6.55													

Notes: Encountered a boulder at 4.5 m (auger refusal)
 - Abandoned borehole & grouted to surface
 - Moved 1 meter further north and continued

○ GRAIN SIZE ANALYSIS ▼ WATER FOUND ▽ STATIC WATER LEVEL

STRATIGRAPHIC AND INSTRUMENTATION LOG

PROJECT NAME: CHESLEY LANDFILL SITE

HOLE NO: OW4-83 Page 1 of 2

JOB NO: 9-847

DATE COMPLETED: JUNE 17, 1983

CLIENT: TOWN OF CHESLEY

GEOLOGIST/ENGINEER: J. KAY

HOLE TYPE: 200 mm DIA. HOLLOW STEM AUGERS

GROUND ELEVATION: 265.305 m AMSL

LOCATION: EAST OF LANDFILL

TOP OF PIPE ELEVATION: 266.340 m AMSL

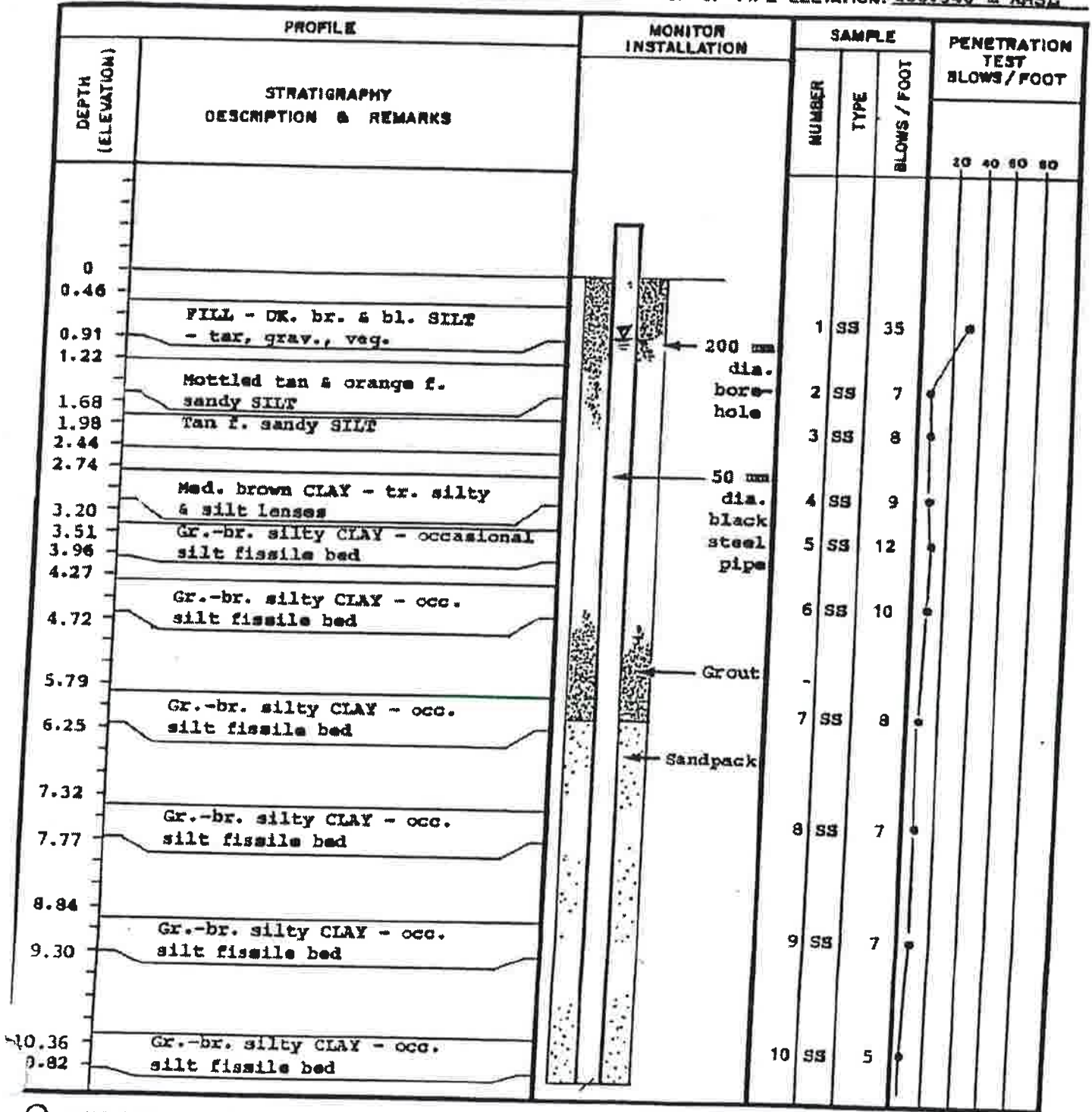

○ GRAIN SIZE ANALYSIS ▼ WATER FOUND ▽ STATIC WATER LEVEL

STRATIGRAPHIC AND INSTRUMENTATION LOG

PROJECT NAME: CHESLEY LANDFILL SITE
 JOB NO: 9-847
 CLIENT: TOWN OF CHESLEY
 HOLE TYPE: 200 mm DIA. HOLLOW STEM AUGERS
 LOCATION: EAST OF LANDFILL

HOLE NO: OW4-83 Page 2 of 2
 DATE COMPLETED: JUNE 17, 1983
 GEOLOGIST/ENGINEER: J. KAY
 GROUND ELEVATION: 265.305 m AMSL
 TOP OF PIPE ELEVATION: 266.340 m AMSL

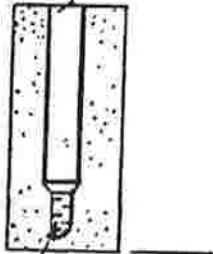
DEPTH (ELEVATION)	PROFILE STRATIGRAPHY DESCRIPTION & REMARKS	MONITOR INSTALLATION	SAMPLE		PENETRATION TEST BLOWS/FOOT												
			NUMBER	TYPE													
11.89 12.33 12.65 12.95 13.17 13.26	Gr. br. silty CLAY - occ silt fissile bed Driller noted change in stratigraphy Brown F. to C. SAND Br.-gr. SILT - grav. sand (TILL)	 <p style="font-size: small;">32 mm dia. galvanized redhead well screen (600 x 760 mm) (#10 slot) Total length 14.24 m pipe, screen & adaptor</p>			<table border="1" style="width: 100%; border-collapse: collapse;"> <tr> <td style="text-align: center;">20</td> <td style="text-align: center;">40</td> <td style="text-align: center;">60</td> <td style="text-align: center;">80</td> </tr> <tr> <td style="text-align: center;">7</td> <td></td> <td></td> <td></td> </tr> <tr> <td style="text-align: center;">82</td> <td></td> <td></td> <td></td> </tr> </table>	20	40	60	80	7				82			
20	40	60	80														
7																	
82																	

○ GRAIN SIZE ANALYSIS ▼ WATER FOUND ▽ STATIC WATER LEVEL

Project: Chesley Landfill
 Client: Municipality of Arran-Elderslie
 Method: H.S.A.
 Elev: 273.94 masl TOC: 274.71 masl

Dia: 180 mm mm
 Depth: 12.34 m
 Supervisor: E. Van Den Kleboom

Project#: 8673
 Date: Nov 17, 11
 Driller: Lantech Drilling

METRES Depth

Stratigraphic
Description

Samples
 Sample Interval
 Sample No.
 Sample Type
 SPT - N Value

Well
Instrumentation

Stickup = 0.77 m metres

Dark Brown Silty Clay with Gravel FILL (Cover Material).

FILL - WASTE

273.5

1
2
3
4
5
6
7
8
9

Strata Plot

1 SS

2 SS

3 SS

4 SS

Granular Bentonite

9.5

Project: Chesley Landfill
 Client: Municipality of Arran-Elderslie
 Method: H.S.A.
 Elev: 273.94 masl TOC: 274.71 masl

Dia: 180 mm mm
 Depth: 12.34 m
 Supervisor: E. VanDenKleboom

Project#: 8673
 Date: Nov 17, 11
 Driller: Lantech Drilling

METRES Depth	Stratigraphic Description	Samples				Well Instrumentation
		Strata Plot	Sample Interval	Sample No.	Sample Type	
	FILL - WASTE			5	SS	Filter Sand
11	263.2 Black to Dark Grey Fine to Medium SAND and GRAVEL. Saturated.			6	SS	10.4 Groundwater Measured @ 10.45 mbgl (Nov. 17, 2011) Groundwater Encountered @ 10.76 mbgl (Nov. 17, 2011)
12	262.2 Black to Light Brown - Grey SAND. Saturated.			7	SS	Screen 51mm, 10 slot PVC
	261.6 E.O.H. @ 12.34 mbgl.			8	SS	11.9 Bottom of well at 11.93 mbgl.
13						
14						
15						
16						
17						
18						
19						

CLIENT <u>Municipality of Arran Elderslie</u>	PROJECT NAME <u>Chesley Landfill</u>
PROJECT NUMBER <u>219126</u>	PROJECT LOCATION <u>230 4th Street SW, Chesley</u>
DATE COMPLETED <u>2019/07/23</u>	CONTRACTOR <u>London Soil Test</u>
LOGGED BY <u>JW</u>	METHOD <u>Hollow Stem Auger</u>
WELL CONSTRUCTION <u>0.05m Ø PVC</u>	NOTES _____

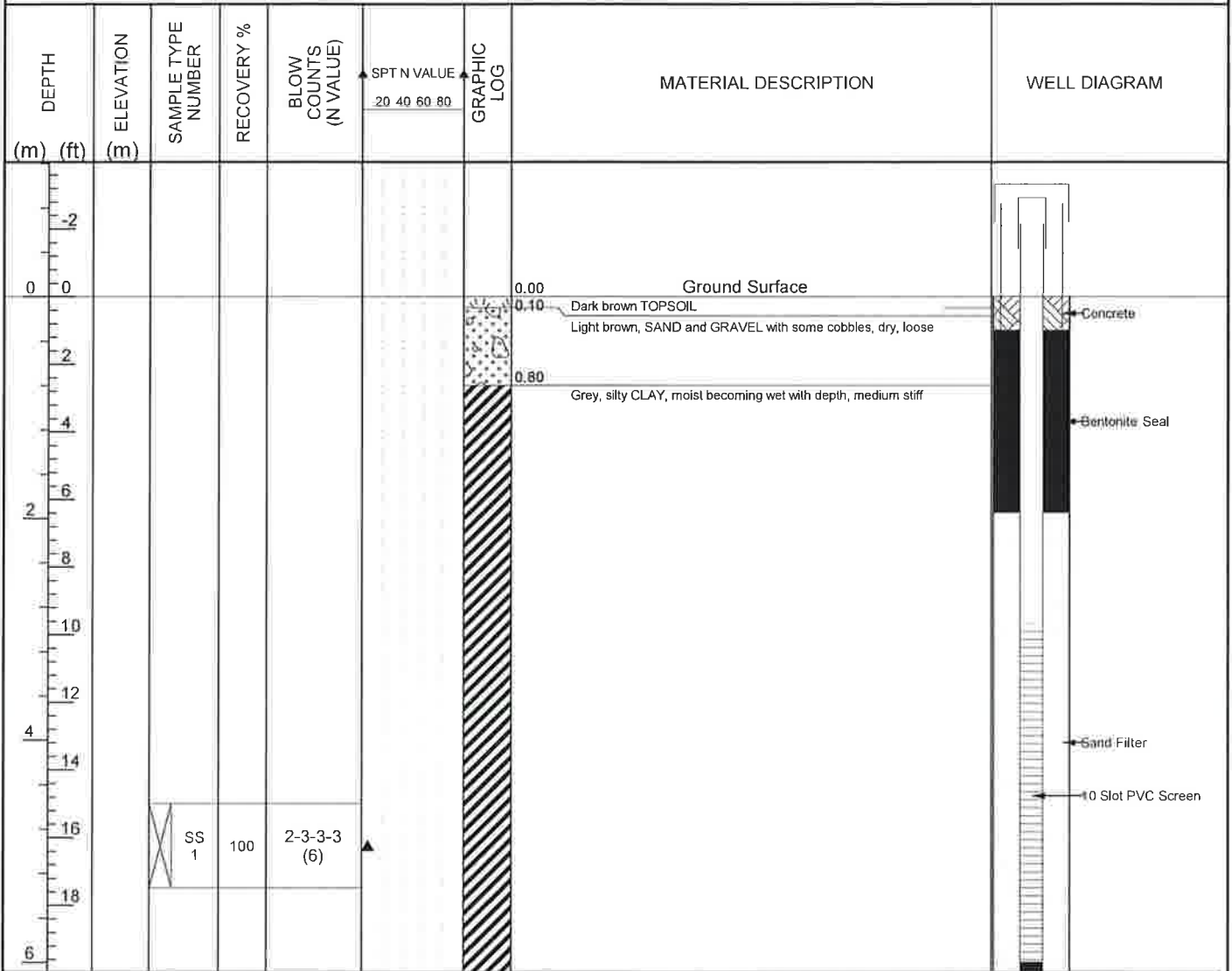

Borehole Terminated at 6.09 m.

CLIENT Municipality of Arran Elderslie **PROJECT NAME** Chesley Landfill
PROJECT NUMBER 219126 **PROJECT LOCATION** 230 4th Street SW, Chesley
DATE COMPLETED 2019/07/23 **CONTRACTOR** London Soil Test
LOGGED BY JW **METHOD** Hollow Stem Auger
WELL CONSTRUCTION 0.05m Ø PVC **NOTES** _____

DEPTH		ELEVATION	SAMPLE TYPE NUMBER	GRAPHIC LOG	MATERIAL DESCRIPTION	WELL DIAGRAM
(m)	(ft)	(m)				
0	0	0.00			Ground Surface	
2		0.45			Dark brown, TOPSOIL	Concrete
4					Brown-grey, fine SAND with some silt and gravel, moist becoming wet with depth	Bentonite Seal
6						
8						
10						Sand Filter
12						
14						10 Slot PVC Screen

Borehole Terminated at 4.57 m

**APPENDIX C:
HISTORIC GROUNDWATER ELEVATION DATA
1992 TO PRESENT**

APPENDIX C

**HISTORIC GROUNDWATER ELEVATION DATA - 1992 TO PRESENT
CHESLEY LANDFILL SITE**

Well	Reference Elevation (m ASL)	May 19/92 Elevation (m ASL)	Oct 26/92 Elevation (m ASL)	May 25/93 Elevation (m ASL)	Oct 18/93 Elevation (m ASL)	May 03/94 Elevation (m ASL)	Oct 21/94 Elevation (m ASL)	May 29/95 Elevation (m ASL)	Oct 11/95 Elevation (m ASL)	May 9/96 Elevation (m ASL)	Sept 25/96 Elevation (m ASL)	May 7/97 Elevation (m ASL)	Oct 23/97 Elevation (m ASL)	Apr 16/98 Elevation (m ASL)	Oct 21/98 Elevation (m ASL)	April 21/99 Elevation (m ASL)	Nov 11/99 Elevation (m ASL)
OW1-83	264.787	263.33	263.01	263.12	263.18	263.06	262.83	262.97	262.91	263.09	262.96	263.31	263.01	263.13	262.88	262.85	262.92
OW2-83	265.055	263.31	263.04	263.13	263.21	263.08	262.86	263.02	262.91	263.10	262.96	263.31	263.02	263.16	262.89	262.90	262.93
OW3-83	267.308	263.89	263.76	263.46	263.65	263.67	263.50	263.67	263.47	263.68	263.49	264.05	263.58	263.79	263.56	263.26	263.10
OW4-83	266.084	265.11	264.74	265.25	264.71	264.99	264.46	264.79	264.39	264.99	264.60	265.56	264.73	265.63	264.46	264.21	263.95
TH1-82	264.909	263.29	262.98	263.09	263.20	263.06	262.85	262.96	262.87	263.06	262.93	263.32	262.99	263.12	262.87	262.87	262.98
OW5-19	264.973																
TH2-81	266.817	265.24	265.65	265.59	265.70	265.68	< 263.50	265.28	< 263.50	265.37	< 263.50	265.74	< 263.50	265.67	< 263.50	265.48	263.50
TH4-81	266.297	263.54	264.08	264.11	264.43	264.36	263.18	263.55	263.17	263.70	263.00	264.45	262.82	263.65	262.93	263.49	263.40
TH6-81	265.738	263.19	264.11	263.48	264.57	264.29	< 261.72	263.48	262.17	263.71	262.33	264.35	262.97	263.96	< 261.72	263.94	264.39
TH7-81	264.311	263.33	263.51	263.52	263.60	263.40	263.08	263.41	263.14	263.42	263.38	263.59	263.25	263.48	262.31	263.36	263.60
TH8-81	263.155	261.83	262.055	261.925	262.305	262.37	261.41	261.89	261.38	262.10	261.35	261.38	261.56	262.16	260.78	262.12	262.15
Cell #1	263.134															262.13	262.23
TH2-02	266.818																
OW6-19	266.835																
TH4-02	265.993																
LW1/11	274.71																

NOTES: Reference elevation from survey completed June 17, 1992 by Henderson Paddon & Associates Limited
 Data presented from May 19, 1992 to October 3, 2018 was completed and provided by WSP
 TH1-82 was decommissioned and replaced by OW6-19 and TH2-02 was decommissioned and replaced by OW5-19 in July 2019
 m ASL = metres above sea level
 Shaded cells indicate a well either not yet being installed or having been removed from monitoring program

APPENDIX C

**HISTORIC GROUNDWATER ELEVATION DATA - 1992 TO PRESENT
CHESLEY LANDFILL SITE**

Well	Reference Elevation (m ASL)	13-Apr-00 Elevation (m ASL)	17-Oct-00 Elevation (m ASL)	24-Apr-01 Elevation (m ASL)	3-Oct-01 Elevation (m ASL)	18-Apr-02 Elevation (m ASL)	24-Oct-02 Elevation (m ASL)	22-May-03 Elevation (m ASL)	30-Oct-03 Elevation (m ASL)	20-May-04 Elevation (m ASL)	30-Sep-04 Elevation (m ASL)	5-May-05 Elevation (m ASL)	29-Sep-05 Elevation (m ASL)	4-May-06 Elevation (m ASL)	28-Sep-06 Elevation (m ASL)	10-May-07 Elevation (m ASL)	4-Oct-07 Elevation (m ASL)
OW1-83	264.787	262.99	263.00	262.24	263.14	263.28	262.91	263.13	263.12	263.23	263.07	263.11	262.88	263.21	262.95	263.21	262.99
OW2-83	265.055	262.93	262.99	263.21	263.00	263.20	263.06	263.11	263.14	263.20	263.02	263.07	262.99	263.10	262.91	263.18	262.95
OW3-83	267.308	263.38	263.45	263.50	263.23	263.28	263.31	263.41	263.32	263.49	263.14	263.17	262.97	263.49	263.27	263.19	263.34
OW4-83	266.084	264.35	264.38	265.14	264.66	265.14	264.37	264.62	264.44	265.12	264.79	265.02	264.48	265.07	264.52	265.12	264.56
TH1-82	264.909	263.00	262.97	263.22	263.09	263.24	262.87	263.10	263.14	263.18	263.20	263.08	263.04	263.11	262.90	263.17	262.92
OW5-19	264.973																
TH2-81	266.817	265.62	264.20	264.16	<263.50	265.61	Removed										
TH4-81	266.297	263.63	263.52	263.53	263.56	Removed											
TH6-81	265.738	264.27	263.50	263.88	263.54	264.16	Dry	263.98	264.25	263.89	262.87	263.91	<261.69	264.00	Dry	263.55	Dry
TH7-81	264.311	263.56	263.28	263.47	263.19	263.55	261.89	263.31	263.59	263.42	262.62	263.31	262.03	263.21	262.11	263.48	261.94
TH8-81	263.155	262.24	261.72	262.13	261.71	262.33	260.07	262.19	262.06	262.16	261.40	262.24	260.50	262.04	260.96	262.05	260.80
Cell #1	263.134	262.23	262.20	262.15	262.23	262.27	262.19	262.24	262.24	262.25	262.21	262.15	262.38	262.17	261.96	262.24	262.21
TH2-02	266.818						Dry	265.34	265.38	265.51	264.25	265.37	261.32	265.23	261.51	265.14	261.31
OW6-19	266.835																
TH4-02	265.993						262.55	263.45	263.63	263.58	263.25	263.57	263.20	263.54	263.17	263.50	262.73
LW1/11	274.71																

NOTE: Reference elevation from survey completed June 17, 1992 by Henderson Paddon & Associates Limited
 Data presented from May 19, 1992 to October 3, 2018 was completed and provided by WSP
 TH1-82 was decommissioned and replaced by OW6-19 and TH2-02 was decommissioned and replaced by OW5-19 in July 2019
 m ASL = metres above sea level
 Shaded cells indicate a well either not yet being installed or having been removed from monitoring program

APPENDIX C

**HISTORIC GROUNDWATER ELEVATION DATA - 1992 TO PRESENT
CHESLEY LANDFILL SITE**

Well	Reference Elevation (m ASL)	15-May-08 Elevation (m ASL)	2-Oct-08 Elevation (m ASL)	21-May-09 Elevation (m ASL)	15-Oct-09 Elevation (m ASL)	6-May-10 Elevation (m ASL)	11-Nov-10 Elevation (m ASL)	5-May-11 Elevation (m ASL)	29-Sep-11 Elevation (m ASL)	19-Apr-12 Elevation (m ASL)	3-Oct-12 Elevation (m ASL)	2-May-13 Elevation (m ASL)	3-Oct-13 Elevation (m ASL)	7-May-14 Elevation (m ASL)	2-Oct-14 Elevation (m ASL)	6-May-15 Elevation (m ASL)	22-Sep-15 Elevation (m ASL)
OW1-83	264.787	263.29	263.09	263.33	263.13	263.13	263.06	264.01	262.03	261.41	260.07	259.58	258.36	259.83	259.71	263.32	263.15
OW2-83	265.055	263.25	263.08	263.30	263.21	263.14	263.03	263.32	263.14	263.22	263.07	263.30	263.15	263.43	263.31	263.31	263.15
OW3-83	267.308	263.56	263.38	263.68	263.43	263.34	263.28	263.53	263.38	263.48	263.34	263.57	263.40	263.70	263.48	263.47	263.34
OW4-83	266.084	265.18	264.75	265.50	264.79	264.89	264.49	264.17	264.73	265.03	264.52	264.99	264.78	265.25	264.90	264.62	265.06
TH1-82	264.909	263.24	263.05	263.28	263.22	263.14	263.11	263.31	263.09	263.20	263.04	263.29	263.12	263.42	263.30	263.28	263.13
OW5-19	264.973																
TH2-81	266.817																
TH4-81	266.297																
TH6-81	265.738	264.02	263.02	263.85	262.59	263.92	263.59	264.00	Dry	263.67	Dry	264.16	261.88	264.25	262.47	263.65	262.18
TH7-81	264.311	263.44	262.95	263.43	263.43	263.62	263.50	263.59	262.09	263.41	262.11	263.59	262.88	263.66	262.81	263.53	262.33
TH8-81	263.155	262.28	261.58	262.07	261.87	262.19	261.87	262.28	260.48	261.86	260.80	262.31	261.25	262.35	261.82	262.01	261.32
Cell #1	263.134	262.17	262.21	262.24	262.16	262.14	262.22	262.26	262.23	262.10	262.08	262.12	262.08	262.29	262.24	262.26	262.23
TH2-02	266.818	265.56	263.16	265.43	263.70	265.10	265.15	265.51	261.85	265.29	261.79	265.54	263.12	265.65	263.74	265.31	262.93
OW6-19	266.835																
TH4-02	265.993	263.62	263.31	263.62	263.63	263.48	263.53	264.65	262.89	263.38	262.99	263.64	263.37	263.74	263.65	263.52	263.55
LW1/11	274.71								263.49	263.59	263.44	263.69	263.49	263.87	263.62	263.58	263.44

NOTE: Reference elevation from survey completed June 17, 1992 by Henderson Paddon & Associates Limited
 Data presented from May 19, 1992 to October 3, 2018 was completed and provided by WSP
 TH1-82 was decommissioned and replaced by OW6-19 and TH2-02 was decommissioned and replaced by OW5-19 in July 2019
 m ASL = metres above sea level
 Shaded cells indicate a well either not yet being installed or having been removed from monitoring program

APPENDIX C

**HISTORIC GROUNDWATER ELEVATION DATA - 1992 TO PRESENT
CHESLEY LANDFILL SITE**

Well	Reference Elevation (m ASL)	4-May-16 Elevation (m ASL)	28-Sep-16 Elevation (m ASL)	5-Jun-17 Elevation (m ASL)	27-Sep-17 Elevation (m ASL)	15-May-18 Elevation (m ASL)	3-Oct-18 Elevation (m ASL)	30-May-19 Elevation (m ASL)	25-Nov-19 Elevation (m ASL)	8-Apr-21 Elevation (m ASL)	Oct-21 Elevation (m ASL)	11-May-22 Elevation (m ASL)	Sep-22 Elevation (m ASL)	11-Apr-23 Elevation (m ASL)	Nov-23 Elevation (m ASL)
OW1-83	264.787	263.41	263.16	263.37	263.24	263.47	263.16	263.46	263.36	263.46	263.04	263.49	263.29	263.48	263.33
OW2-83	265.055	263.38	263.15	263.34	263.21	263.46	263.21	263.40	263.36	263.43	263.25	263.44	263.15	263.53	262.29
OW3-83	267.308	263.63	263.40	263.51	263.41	263.61	263.38	263.64	263.42	263.47	263.37	263.60	263.43	263.65	263.45
OW4-83	266.084	264.08	264.18	264.35	264.23	264.94	264.25	264.41	264.38	264.38	264.45	264.34	263.86	264.38	264.42
TH1-82	264.909	263.36	263.16	263.33	263.19	263.53	263.27	263.43	Removed						
OW5-19	264.973								263.21	263.22	263.23	263.25	263.23	263.62	263.45
TH2-81	266.817														
TH4-81	266.297														
TH6-81	265.738	263.76	Dry	263.75	262.27	264.17	Dry	264.26	264.39	263.91	263.74	263.94	261.76	264.21	
TH7-81	264.311	263.56	262.11	263.47	262.68	263.67	261.82	263.58	263.58	263.61	263.25	263.59	261.90	263.61	
TH8-81	263.155	262.02	260.76	262.03	261.39	262.44	260.48	262.27	262.17	262.30	261.79	262.31	261.84	262.44	262.01
Cell #1	263.134	262.25	262.24	Dry	262.07	262.19	262.18	-	-	-	-	-	-	-	-
TH2-02	266.818	265.33	261.42	265.21	263.42	265.74	261.37	265.48							
OW6-19	266.835								265.32	265.21	264.30	265.32	262.67	265.71	263.79
TH4-02	265.993	263.57	263.44	263.51	263.46	263.62	263.16	263.70	263.70	263.57	263.49	263.53	263.07	263.71	
LW1/11	274.71	263.80	263.55	263.65	263.52	263.75	263.51	263.81	263.60	263.76	263.53	263.80	263.59	263.86	262.78

NOTE: Reference elevation from survey completed June 17, 1992 by Henderson Paddon & Associates Limited
 Data presented from May 19, 1992 to October 3, 2018 was completed and provided by WSP
 TH1-82 was decommissioned and replaced by OW6-19 and TH2-02 was decommissioned and replaced by OW5-19 in July 2019
 m ASL = metres above sea level
 Shaded cells indicate a well either not yet being installed or having been removed from monitoring program

**APPENDIX D:
GUIDELINE C-7 BURNING AT LANDFILL SITES (APRIL 1994)**

GUIDELINE C-7
(formerly 14-08)

Burning at Landfill Sites

Legislative Authority:

*Environmental Protection Act, RSO 1990, Sections 6, 14
and 27*
Ontario Regulation 347, Sections 1 and 12.1

Responsible Director:

Director, Program Development Branch

Last Revision Date:

April, 1994

Table of Contents

1.0 INTRODUCTION

2.0 GENERAL REQUIREMENTS

2.1 Other Agencies

2.2 Certificate of Approval

3.0 OPERATIONAL REQUIREMENTS

SYNOPSIS

The primary purpose of this guideline is to provide a set of operational requirements for the orderly burning of segregated clean wood and brush in a safe and environmentally- acceptable manner at appropriate landfill sites. This guideline is intended for use by landfill operators in their operation of a landfill site, and by Ministry staff during their review and inspection of landfill operations. The operational requirements are provided in Section 4-21, "Open Burning of Waste", of Procedure C-8-1: "Guidance Manual for Landfill Sites Receiving Municipal Waste" (C-8-1).

The guideline shall be enforced by including appropriate conditions on a Certificate of Approval for a landfill site, and by the Regions during the normal course of their activities.

1.0 Introduction

The burning of municipal waste, except for a limited number of specific materials, is prohibited by O. Regulation 347, Section 12.1. Segregated clean wood and brush, however, may be burned at certain sites, subject to certain requirements. These requirements are detailed in Section 4.21 of Procedure C-8-1: "Guidance Manual for Landfill Sites Receiving Municipal Waste".

2.0 General Requirements

As part of an overall program to maximize waste capacity at existing landfill sites, thereby extending their life, burning of clean wood and brush may be allowed under strictly controlled conditions.

2.1 Other Agencies

The Ministry of Natural Resources and local municipal authorities shall be consulted to obtain any necessary permits. Specific regulations enforced by the Ministry of Natural Resources shall be complied with for burning wood and brush at landfills located north of Ontario's fire line.

2.2 Certificate of Approval

Burning of any kind is not permitted at new landfill sites unless specifically allowed in the Certificate of Approval.

3.0 Operational Requirements

The operational requirements are detailed under Section 4.21.3 of the guidance manual under the headings of:

- (a) Weather and Atmospheric Conditions,
- (b) Supervision,
- (c) Environmental Controls,
- (d) Extinguishing Requirements,
- (e) Access Control, and
- (f) Resolution of Complaints.

4.21.3 Operational Requirements

a) Weather and Atmospheric Conditions

Burning should be carried out only when prevailing weather and atmospheric conditions are suitable. Burning should not be carried out when:

- i) the area has a high Air Quality Index (AQI);
- ii) rain or fog are present, since smoke cannot disperse properly and may be concentrated in one particular area; and
- iii) wind speeds are high or wind directions are changing frequently, because these conditions allow fires to spread rapidly.

b) Supervision

- i) Dry brush and clean wood wastes should be segregated and subsequently burned on a designated, cleaned area of the site, under supervision of the site operator.
- ii) The fire should be supervised continuously until completely extinguished.
- iii) The site operator should clear residual ashes from a fire and dispose of the ash with normal incoming waste as soon as practically possible. The ashes must be cold prior to mixing with waste. Residual ashes should not be allowed to accumulate at the designated burning area.

c) Environmental Controls

- i) Petroleum products, plastics, rubber or any other material that will cause excessive smoke or noxious fumes must not be mixed with or contaminate the wood or brush that may be burned.
- ii) Burning should not be carried out if there is sensitive land-use adjacent to the landfill site or if the nearest dwelling is less than 150 metres from the site.
- iii) A 30 metre fire break should be provided around the burning area.
- iv) Ontario Regulation 308, made under the EPA, contains provisions dealing with air pollution. Owners and site operators are advised to apprise themselves of the provisions contained therein.

d) Extinguishing Requirements

The area of burning on the landfill site must be restricted in order to enable the operator to extinguish the fire immediately if necessary due to a change in weather or other conditions or if so ordered by MOEE or Ministry of Natural Resources staff. The operator must also provide proof of this ability (i.e., on-site equipment or written agreement with local fire control agency) to extinguish the fire.

e) Access Control

- i) Access to the landfill site by the public and other unauthorized personnel must be restricted when burning is carried out.
- ii) Appropriate signs should be posted at all entrances to the site used by the public and waste haulers advising them of restricted access due to burning of waste.

f) Resolution of Complaints

- i) Complaints from local residents regarding smoke or odour emissions will have to be resolved by the operator. If this is not corrected satisfactorily, the operator would be required to stop burning.
- ii) When persistent problems are encountered with burning at existing sites, the operator may be requested either to stop burning or make a satisfactory proposal to control burning for incorporation in the Certificate of Approval for the site. This may involve a request for amendment of a current Certificate of Approval. If the operator does not comply voluntarily with such a request, formal action to halt burning may be taken under provisions of the EPA.

4.21 OPEN BURNING OF WASTE

4.21.1 Rationale

The burning of municipal waste, except a limited number of specific material, is prohibited by regulation in Ontario. Open burning of waste at a landfill site creates

- a) air emission concerns;
- b) public and environmental hazards;
- c) lack of site operational control;
- d) fire hazard; and
- e) nuisance.

Segregated, clean wood and brush, however, may be burned at certain isolated sites, subject to weather and atmospheric conditions and supervision requirements.

4.21.2 General Requirements

- a) As part of an overall program to maximize waste capacity at existing landfill sites, thereby extending their life, open burning of clean wood and brush may be allowed under strictly controlled conditions as discussed in this subsection.

The Ministry of Natural Resources and local municipal authorities should be consulted in order to obtain any necessary permits for burning. These agencies may require specific details on safety precautions and fire prevention measures that will be taken. Landfill site owner/operators are also advised to check for any municipal by-laws enforced by the local police and fire departments. Specific regulations enforced by the Ministry of Natural Resources must be complied with for burning north of Ontario's fire line. The fire line runs east from Lake Huron across the bottom of Georgian Bay and the top of Lake Simcoe down to Gananoque, then north and west to meet the Ottawa River north of Renfrew.

- b) Burning is not permitted at new landfill sites unless specifically allowed in the Certificate of Approval, usually conditional on the compliance with various environmental and safety considerations. Any permit to burn waste at new landfill sites would also be conditional on compliance with local municipal by-laws, and specific requirements of The Ministry of Natural Resources.

4.21.3 Operational Requirements

a) Weather and Atmospheric Conditions

Burning should be carried out only when prevailing weather and atmospheric conditions are suitable. Burning should not be carried out when:

- i) the area has a high Air Quality Index (AQI);
- ii) rain or fog are present, since smoke cannot disperse properly and may be concentrated in one particular area; and
- iii) wind speeds are high or wind directions are changing frequently, because these conditions allow fires to spread rapidly.

b) Supervision

- i) Dry brush and clean wood wastes should be segregated and subsequently burned on a designated, cleaned area of the site, under supervision of the site operator.
- ii) The fire should be supervised continuously until completely extinguished.
- iii) The site operator should clear residual ashes from a fire and dispose of the ash with normal incoming waste as soon as practically possible. The ashes must be cold prior to mixing with waste. Residual ashes should not be allowed to accumulate at the designated burning area.

c) Environmental Controls

- i) Petroleum products, plastics, rubber or any other material that will cause excessive smoke or noxious fumes must not be mixed with or contaminate the wood or brush that may be burned.
- ii) Burning should not be carried out if there is sensitive land-use adjacent to the landfill site or if the nearest dwelling is less than 150 metres from the site.
- iii) A 30 metre fire break should be provided around the burning area.
- iv) Ontario Regulation 308, made under the EPA, contains provisions dealing with air pollution. Owners and site operators are advised to apprise themselves of the provisions contained therein.

d) Extinguishing Requirements

The area of burning on the landfill site must be restricted in order to enable the operator to extinguish the fire immediately if necessary due to a change in weather or other conditions or if so ordered by MOEE or Ministry of Natural Resources staff. The operator must also provide proof of this ability (i.e., on-site equipment or written agreement with local fire control agency) to extinguish the fire.

e) Access Control

- i) Access to the landfill site by the public and other unauthorized personnel must be restricted when burning is carried out.
- ii) Appropriate signs should be posted at all entrances to the site used by the public and waste haulers advising them of restricted access due to burning of waste.

f) Resolution of Complaints

- i) Complaints from local residents regarding smoke or odour emissions will have to be resolved by the operator. If this is not corrected satisfactorily, the operator would be required to stop burning.
- ii) When persistent problems are encountered with burning at existing sites, the operator may be requested either to stop burning or make a satisfactory proposal to control burning for incorporation in the Certificate of Approval for the site. This may involve a request for amendment of a current Certificate of Approval. If the operator does not comply voluntarily with such a request, formal action to halt burning may be taken under provisions of the EPA.

**APPENDIX E:
SUMMARY OF GROUNDWATER ANALYTICAL RESULTS
(TABLES & GRAPHS)**

HISTORIC GROUNDWATER QUALITY DATA
Leachate Observation Well LW-1/11

DATE	Temp (°C) (field)	Calcium	Magnesium	Sodium	Potassium	Alkalinity as CaCO3	Sulphate	Chloride	Hardness	pH	pH (field)	Conduct. (field)	Conduct. (field)	Iron	Phenols	Ammonia NH ₃ as N	TKN as N	Organic Nitrogen	Nitrite as N	Nitrate as N	DOC	Magnese	Total Phosphorus	
ODWQ5			200			30 - 500	500	250	80 - 100	6.5 - 8.5	6.5 - 8.5			0.3				0.15	↑***	10***	5	0.05		
24-Nov-11	9.0	189	45.4	22.8	7.4	586	40	36.1	660	7.61	7.1	1180	1103	5.56	<	1	0.89	0.54	<0.01	0.1	0.2	3.2	0.151	0.94
19-Apr-12	10.2	149	40.8	18.3	6.5	519	33	31.6	539	7.32	6.8	1050	1058	5.39	<	1	0.71	1.10	0.39	<0.1	0.1	1.4	0.124	0.28
4-Oct-12	10.3	142	40.6	17.3	6.0	459	33	29.4		7.74	6.96	927	1087	3.97	<	1	0.08	0.52	0.44	<0.1	0.2	1.3	0.124	0.46
2-May-13	10.5	168	39.6	21.3	8.0	509	29	31.0		7.38	6.83	1020	967	6.13	<	1	3.02	4.25	1.23	<0.1	<0.1	4.0	0.132	0.34
3-Oct-13	10.3	176	39.6	19.3	5.9	566	32	27.8		7.51	6.58	1030	936	4.65	<	1	0.24	0.56	0.32	<0.1	<0.1	6.5	0.156	0.26
7-May-14	9.9	125	33.9	19.0	7.2	310	31	28.1		7.59	6.96	892	914	3.69	<	1	3.55	5.45	1.90	<0.1	<0.1	9.1	0.107	1.43
2-Oct-14	10.4	159	39.9	19.3	6.0	485	30	26.9		7.65	6.90	1010	948	3.97	<	1	0.27	3.11	2.84	<0.1	<0.1	7.1	0.124	3.61
6-May-15	11.1	178	40.5	19.3	6.1	519	32	24.7		7.53	7.01	984	950	3.91	<	1	0.45	1.89	1.44	<0.1	<0.1	9.2	0.143	1.25
22-Sep-15	10.9	176	40.5	19.5	5.6	541	33	24.2		7.46	7.63	1040	1025	4.17	<	1	0.16	0.85	0.69	<0.1	0.1	1.1	0.185	0.65
4-May-16	9.9	130	39.0	20.7	6.6	501	31	27.1	485	7.63	6.90	921	993	4.52	<	1	2.23	3.09	0.86	<0.1	<0.1	2.1	0.129	0.02
28-Sep-16	10.7	168	40.5	20.1	5.4	563	30	25.6		7.74	6.80	1060	976	3.74	<	1	0.17	0.29	0.12	<0.1	<0.1	2.7	0.152	0.01
5-Jun-17	10.1	142	38.6	19.2	5.5	465	29	19.9	513	7.49	6.75	964	895	2.79	<	1	0.31	0.6	0.29	<0.05	<0.05	1.3	0.112	0.04
27-Sep-17	10.7	171	41.4	16.9	5.6	511	27	20.1		7.48	6.77	1030	838	3.69	<	1	0.09	0.3	0.21	<0.05	<0.05	4.1	0.163	0.03
15-May-18	10.2	144	45.0	18.6	6.6	419	35	24.8	545	7.76	7.19	893	849	3.38	<	1	1.00	1.6	0.6	<0.05	<0.05	1.8	0.151	0.62
3-Oct-18	9.6	149	41.9	16.2	5.6	457	33	21.3	545	7.33	6.76	1000	848	3.45	<	1	0.11	0.5	0.39	<0.05	<0.05	4.4	0.163	0.40
25-Nov-19	129	35.0	14.5	5.0				25.5	466	7.47		955			<	0.002	0.13	0.2	0.07	<0.05	0.17	2.2		0.05
20-May-20	133	39.5	14.1	5.0				19.1	494	7.67		868			<	0.002	0.4	0.5	0.10	0.06	0.1	2.7		0.07
6-Nov-20	153	39.9	15.7	5.3				21.1	547	7.81		976			<	0.002	0.10	1.4	1.3	<0.05	<0.05		0.90	0.29
8-Apr-21	137	38.7	15			440		20.6	502	7.64		909		2.17	<	0.002	0.30	0.50	0.2	<0.05	0.07	6.5		0.17
7-Oct-21	141	34.7	13			480		22.2	495	7.23		1010		3.38	<	0.002	0.18	0.9	0.72	<0.05	<0.05	3.8		0.54
11-May-22	124	35.8	15	5.1				26.3	457	7.5		875		1.64	<	0.001	0.8	1.10		<0.05	0.08	2.4		0.33
15-Sep-22	136	40.3	16.5	5.3				23.8	505	7.43		915			<	0.001	0.15	2.80		<0.05	<0.05	2.6		1.65
11-Apr-23	127	35.8	19.3	6.9	465			26.4		7.54		926			<	0.006	2.51	2.7		<0.05	0.12	6.6		0.51
2-Nov-23	133	39.5	16.9	5.2	453			31	495	7.38		955			<	0.001	<0.05	6.2		<0.05	<0.05	7.2		4.09
Average	10.3	149.1	39.4	17.8	6.0	486.7	31.9	25.6	517.7	7.5	6.9	974.6	959.1	3.9	<	1.0	0.8	1.7	0.7	0.1	0.1	4.1	0.2	0.8
Maximum	11.1	189.0	45.4	22.8	8.0	586.0	40.0	36.1	660.0	7.8	7.6	1180.0	1103.0	6.1	<	1.0	3.6	6.2	2.8	0.1	0.2	9.2	0.9	4.1
Minimum	9.0	124.0	33.9	13.0	5.0	310.0	27.0	19.1	457.0	7.2	6.6	868.0	838.0	1.6	<	0.0	0.1	0.2	0.1	0.1	0.1	1.1	0.1	0.0
St. Dev	0.5	19.4	2.8	2.5	0.8	62.4	3.0	4.3	50.0	0.2	0.2	72.8	84.0	1.1	<	2.0	1.0	1.7	0.7	NA	0.1	2.5	0.2	1.1

DATE	As	BOD	COD	TSS	Barium	Boron	Cadmium	Chromium	Copper	Lead	Mercury	Zinc	TDS (calc)	Benzene	Dichlorobenzene 1,4	Dichloromethane (Methyl Chloride)	Toluene	Vinyl Chloride	
ODWQ5	0.025***				1	5	0.005	0.05	1	0.01c	0.001	5	500	0.005	0.005	0.05	0.024	0.002	
24-Nov-11	0.0038			1450	0.057	0.047	<0.00002	<	0.002	<0.002	<0.00002	0.009	684	0.0014	<	0.0002	<	0.0003	
19-Apr-12	0.0009	4	<5	14	0.044	0.073	<0.00002	<	0.002	<0.002	<0.00002	0.006	614	<0.0005	<	0.0005	<	<0.0003	
4-Oct-12	0.0010	5	<5	10	0.044	0.061	<0.00002	<	0.002	<0.002	<0.00002	<0.005	549	<0.0005	<	<0.0002	<	<0.0003	
2-May-13	0.0013	14	7	448	0.058	0.073	<0.00002	<	0.002	<0.002	<0.00002	<0.005	613	<0.0005	<	0.0005	<	<0.0003	
3-Oct-13	0.0013	12	<5	7	0.048	0.044	<0.00002	<	0.002	<0.002	<0.00002	<0.005	645	<0.0005	<	0.0005	<	<0.0003	
7-May-14	0.0014	7	5	1680	0.042	0.073	<0.00002	<	0.0005	0.0001	<0.00002	<0.00002	<0.005	631	<0.0005	<	<0.0002	<	<0.0003
2-Oct-14	0.0067	13	196	6220	0.045	0.065	<0.00002	<	0.002	<0.002	<0.00002	<0.00002	<0.005	576	<0.0005	<	<0.0002	<	<0.0005
6-May-15	0.0034	6	115	1250	0.048	0.069	<0.00002	<	0.002	<0.002	<0.00002	<0.00002	<0.005	616	0.0008	<	0.0011	<	<0.0003
22-Sep-15	0.0026	<3	64	8	0.050	0.067	<0.00002	<	0.002	<0.002	<0.00002	<0.00002	<0.005	707	<0.0005	<	<0.0002	<	<0.0003
4-May-16	0.0017	10	96	1050	0.041	0.035	<0.00002	<	0.002	0.002	<0.00002	<0.00002	<0.005	559	<0.0005	<	0.001	<	<0.0003
28-Sep-16	0.0077	13	181	6310	0.052	0.063	<0.00002	<	0.002	<0.002	<0.00002	<0.00002	<0.005	631	<0.0005	<	0.0006	<	<0.0003
5-Jun-17	<0.001	3	68	1370	0.042	0.058	<0.00014	<	0.002	<0.002	<0.00002	<0.00002	<0.005	530	<0.0005	<	<0.0002	<	<0.0003
27-Sep-17	0.002	13	5	3230	0.047	0.066	<0.00014	<	0.002	<0.002	<0.00002	<0.00002	<0.005	592	<0.0005	<	0.0006	<	<0.0003
15-May-18	0.002	5	77	810	0.045	0.072	<0.00014	<	0.002	<0.002	0.0057	<0.00002	0.022	523	<0.0005	<	0.0004	<	<0.0003
3-Oct-18	0.0017	3	30	480	0.042	0.057	<0.00001		0.003	0.002	0.00174	<0.00002	0.010	545	<0.0005	<	<0.0005	<	<0.0003
Average	0.0027	8	77	1622	0.05	0.062	0.00002		0.002	0.001	0.00002	0.00002	0.012	601	0.0011		0.0007		0.0003
Maximum	0.0077	14	196	6310	0.058	0.073	0.00002		0.003	0.002	0.00002	0.00002	0.022	707	0.0014		0.0011		0.0003
Minimum	0.0009	3	5	7	0.041	0.035	0.00002		0.0005	0.0001	0.00002	0.00002	0.006	523	0.0005		0.0002		0.0003
Count	15	14	14	15	15	15	15	15	15	15	15	15	15	15	15	15	15	15	15

All results expressed as mg/L except the following parameters:

pH as -log [H⁺]

phenols as ppb

conductivity as µS/cm

* denotes duplicate sample

** unsuitable for analysis, oil present

c - applies to water at the point of consumption

Leachate Well LW1-11

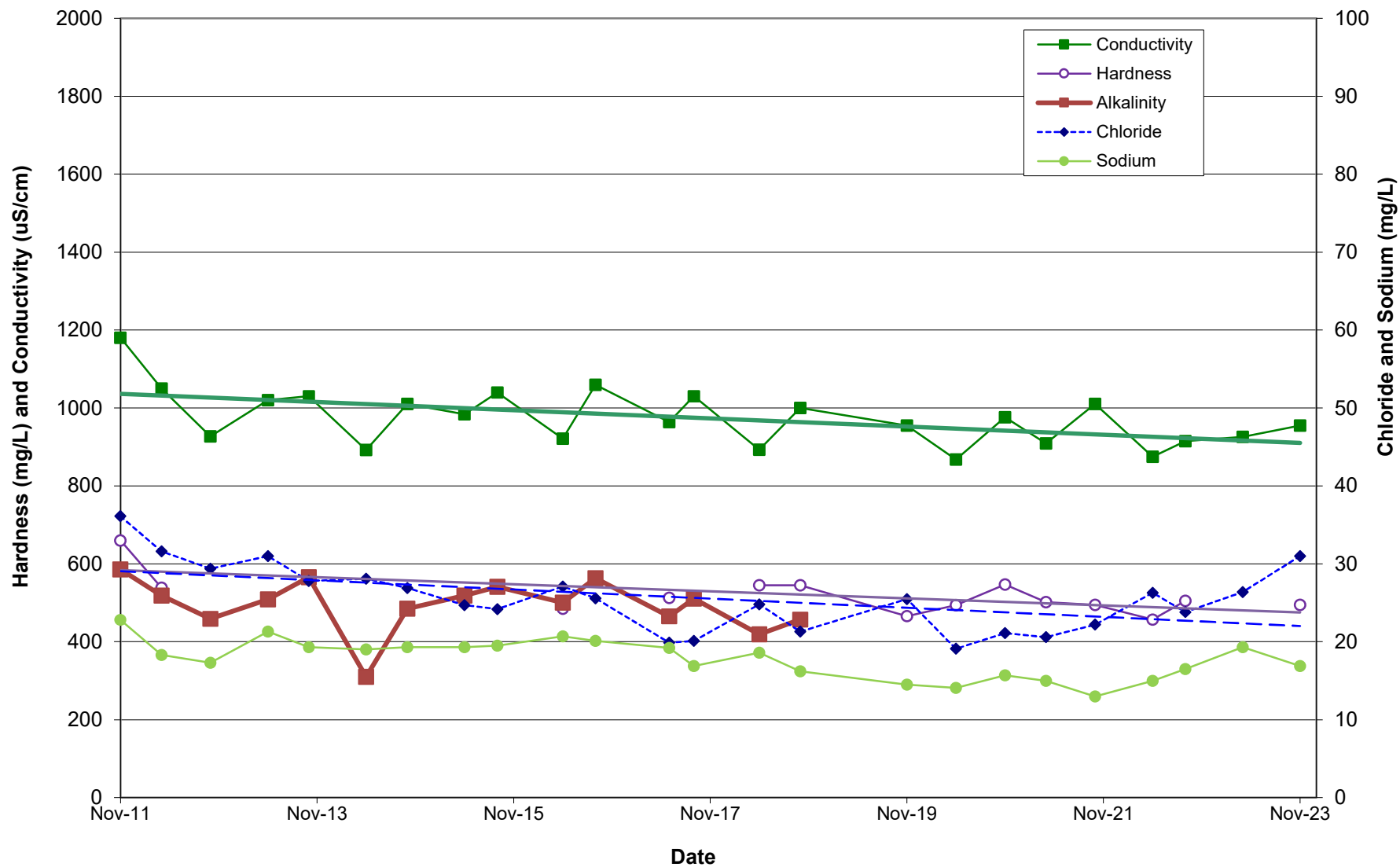

HISTORIC GROUNDWATER QUALITY DATA
Leachate Manhole MH-7

DATE	Temp (°C) (field)	Calcium	Magnesium	Sodium	Potassium	Sulphate	Chloride	Hardness	pH	pH (field)	Conduct	Conduct (field)	Iron	Phenols	Ammonia NH ₃ as N	TKN as N	Organic Nitrogen	Nitrite as N	Nitrate as N	DOC	Mn	Total Phosphorus	o-PO ₄	BOD	COD		
ODWGS				200		500	250	80 - 100	6.5 - 8.5	6.5 - 8.5			0.3				0.15	1***	10***	5	0.05						
Nov-87		155	37				55	542	7.19		3630			10.5							72						
May-88		95	38				41	396	7.6		1010			1							52			36			
Nov-88		146	44				44	546	7.04		1101			4	0.8	3.55					51			37	160		
May-89		130	77				62	642	6.39		1480			19											350		
May-90		116	36.6				22.5	441	7.26		852			10	1.3	3.2									1.96		
3-Jun-91																											
19-Nov-91		295	75				66.9	1047	6.98		1850				54										96	300	
19-May-92															513	0.1	8.8										
28-Oct-92		132	76.8				110	648	7.00		**			**	17	124				**	**				>750		
25-May-93		289	116				179	1200	7.86		2630			310	12	29.5									400	*1150	
18-Oct-93		87.6	32.9				8.7	355	7.37		684			48.5	0.45	0.71+									1.2	8	
3-May-94		82.2	30.4				7.8	331	7.65		648			3.6	0.036	0.49						0.115			0.74	6	
21-Oct-94		87.1	34.6				9.4	360	7.46		676		<	1	0.037	5.1				1.4		1.98			6.30	13	
29-May-95		89.1	33.8				7.8	362	7.39		659		<	2.3	0.07	0.74			0.04	3.9					1.24	6	
11-Oct-95		91.8	35.4				10.8	375	7.25		692		<	1	0.51	0.57			0.05	4.3			0.06		1.1	4	
9-May-96		106	42.3				8.7	439	7.12		652		<	1	0.02	0.23			<-0.1	3.4	<	1		0.01	<	1	<
25-Sep-96		88.4	35.3				9.2	366	7.13		676		<	1	0.06	0.29			<-0.1	3.9	<	1		0.02		12	3
8-May-97		88.9	33.5				11.4	360	7.41		697			4	0.69						4				17	43	
23-Oct-97		108	50.9	6.9	4.2		11.1	479	7.20		703		<	1	0.02	0.47			<-0.1	3.9	<	1		0.20		7	31
23-Oct-97	DUP	103	50.7	6.2	3.8		11.1	466	7.34		702		<	1	0.02	0.55			<-0.1	3.8	<	1		0.20		4	34
18-Apr-98		90.5	36.7				10.8	377	7.46		683		<	1	0.10	0.20			<-0.1	3.9	<	1		0.02		3	2
21-Oct-98	NOT SAMPLED																										
21-Apr-99		130	46.2	8.3	4.2		13.3	515	7.17		782		<	0.005	0.39	1			<-0.1	3.1		3	0.182	0.38		2	61
11-Nov-99	NO FLOW																										
13-Apr-00		143	34.6			41.2	12.4	500	6.96		778		<	1	0.38	0.72	0.34		<-0.1	2.1		5		0.01	<0.01	10	2
17-Oct-00		99.3	38	7.89	2.91		11.4	404	6.64		744		<	1	0.25	0.64	0.39	0.3		2.0	16		0.04		4	13	
24-Apr-01		86.8	37.1	8.1	3.4		13.8	369	7.37		745			3	0.44	1.54	1.1	0.3		3.3	5						
3-Oct-01		93.6	36.1	5.2	2.6		10.3	382	7.52		690		<	1	0.48	0.54	0.06		<-0.1	4.3	<	1					
18-Apr-02		94.3	37.4	3.3	1.8		10.2	389	6.95		698		<	1	0.01	0.19	0.18		<-0.1	4.8	4						
24-Oct-02		104	38.6	5.3	3.4		9.9	419	7.78		692		<	3.1	0.05	0.19	0.14		<-0.1	4.7	<	0.5		0.02	<0.01	<	1
22-May-03		94.8	34.9	5.6	<0.4		9.7	380	7.76		663		<	1	<0.01	0.49	0.48		<-0.1	4.0	0.6			0.1	<0.01	<	1
30-Oct-03		95.9	36.7	7.3	2.7		10.4	391	7.84		698		<	1	0.07	2.37	2.3		<-0.1	4.2	9						
20-May-04				5.5	2.3		9.8	381	7.43		626		<	1	<0.01	0.97	0.96		<-0.1	4.8	0.7	0.036	0.24	<0.01	1	14	
30-Sep-04		90	33.8	5.4	2.3		9.6	364	7.89		659		<	1	<0.01	0.52	0.51		<-0.1	4.6	0.5		0.12	<0.01	12	10	
5-May-05	9.2	85.8	34.1	5.7	2.3		10.5	355	7.15	7.6	665	630	<	1	0.02	3.01	2.99		<-0.1	4.3	1.6		1.12	<0.01	<	3	
29-Sep-05	10.5	197	66.3	26.7	11.6		38.9	764	7.71	8.9	912	856	<	21	0.93	3.14	2.21	0.4	2.8	23.3		0.47	<0.01	30	62		
4-May-06	9.2	95.3	35.9	7	3.1		12.4	366	7.65	7.5	688	670	<	2	0.19	1.11	0.92	<-0.1	4.4	3.2		0.09		<	3		
28-Sep-06	10.2	76.8	32.4	14.3	3.8		11.9	325	7.7	7.9	671	681	<	1	0.3	4.1	3.8		<-0.1	4.2	5.3		1.42		4	95	
10-May-07	9.5	93.2	34.9	8	3.4		13.3	377	7.82	7.5	666	690	<	3.1	0.3	0.55	0.25		<-0.1	4.2	1.1		0.02		<	3	
4-Oct-07	10.9	68.4	44.5	6	3.4		10	354	7.4	7.1	597	634	<	1	0.14	0.42	0.28		<-0.1	4.1	<	0.5		0.06	<	3	
15-May-08	9.5	105	39.5	9	3.9		13.7	424	7.69	7.6	673	677	<	3.9	0.38	0.89	0.51		<-0.1	4	1.3		0.08		<	3	
2-Oct-08	9.9	84.4	30.8	6.1	2.9		11.6	338	8.03	7.0	629	593	<	1	0.25	0.42	0.17		<-0.1	4.2	1.1		0.02		<	3	
21-May-09	9.4	95.2	35.5	8.7	4		13.5	384	7.73	7.9	730	678	<	2	0.65	0.93	0.28		<-0.1	3.8	1.8		0.02		<	3	
15-Oct-09	8.9	117	42.3	8.7	4		13.9	467	7.7	8.1	705	735	<	2	1.03	1.61	0.58		<-0.1	3.7	1.6		0.11		7		
6-May-10	8.4	99.4	37.6	12.8	5		17.1	403	7.71	7.6	752	862	<	1	1.12	1.61	0.49		<-0.1	3.6	2		0.04		<	3	
11-Nov-10	9.8	134	47.7	10	4		15.9	530	7.17		726		<	1	0.88	1.54	0.66		<-0.1	3.6	1.8		0.13		<	3	
5-May-11	8.8	95.9	36.8	9.0	3.0		14.9	391	6.93	7.9	743	567	<	1	0.84	0.94	0.10		<-0.1	3.7	1.5		<0.01		<	3	
30-Sep-11	11.4	131	47.8	9.6	4.3		13.8	523	7.57	7.2	745	690	<	1	0.40	1.43	1.03		<-0.1	3.5	1.2		0.26		<	3	
19-Apr-12	9.3	77.7	34.5	8.3	3.2		13.9	336	7.66	7.2	695	704	<	1	0.37	0.55	0.18		<-0.1	3.5	1.0		0.01		<	3	
3-Oct-12	10.8	95.5	37.1	9.0	3.8		14.8	391	8.10	7.36	693	745	<	1	0.75	1.08	0.33		<-0.1	3.3	1.9		0.01		<	3	
2-May-13	9.4	107	38.8	10.9	3.7		15.9	427	7.80	7.38	721	683	<	1	0.69	1.52	0.83		<-0.1	3.1	2.0		0.11		<	3	
3-Oct-13	10.1	93.1	35.0	8.4	3.2		13.0	376	7.61	7.13	651	597	<	3.1	0.28	0.54	0.26		<-0.1	3.4	6.2		0.02		<	3	
7-May-14	8.8	89.3	33.2	11.6	3.0		20.6	360	7.77	7.36	666	701	<	1	0.40	0.60	0.20		<-0.1	3.2	2.7		0.02		<	3	
2-Oct-14	10.3	90.3	33.9	8.4	3.0		14.2	365	7.92	7.44	670	633	<	3.0	0.22	0.55	0.33		<-0.1	3.3	2.5		0.01		<	3	
6-May-15	9.9	96.8	37.0	9.5	3.2		14.2	394	7.94	7.55	653	612	<	1	0.44												

Manhole MH-7

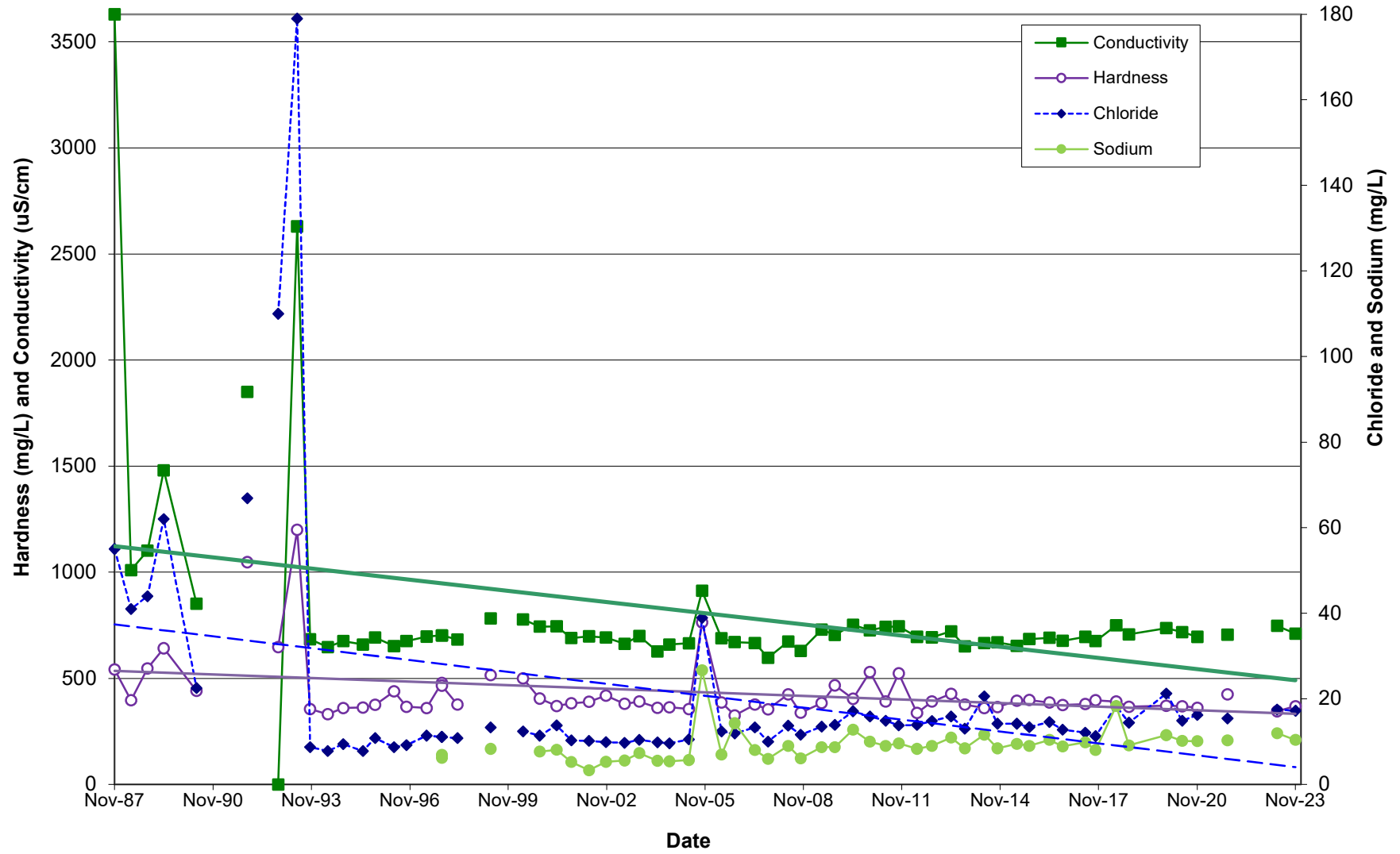

HISTORIC GROUNDWATER QUALITY DATA
Leachate Manhole MH-8

DATE	Temp (°C) (field)	Calcium	Magnesium	Sodium	Potassium	Sulphate	Chloride	Hardness	pH	pH (field)	Conduct.	Conduct. (field)	Phenols	Ammonia NH ₃ as N	TKN as N	Organic Nitrogen	Nitrite as N	Nitrate as N	DOC	Magnese	Total Phosphorus	o-PO ₄	BOD	COD	
ODWGS			200			500	250	80 - 100	6.5 - 8.5	6.5 - 8.5									5	0.05					
1-Nov-87		212	109				125	979	6.79		2590		205	19.4	45.5		0.03	<0.1	505		2.75		435	850	
1-May-88		324	145				110	1407	6.52		2410		180						260				210		
1-May-88		239	99				73	1003	6.59		1700		130										21	145	
1-Nov-88		144	89				93	728	6.50		1950		12	39.8	42.5				38				39.8	350	
1-May-90		1120	473				40.9	*4749	6.46		1114		9.5	14.5	185										
3-Jun-91							51.8		6.56		1139		12	14.1				<0.1	39		2.1				
19-Nov-91		162	79				75.4	730	6.52		1590		28	10	22.5								8.8	84	
19-May-92							59.8		6.51		1340		70.5	14	18.2										
26-Oct-92		176	95.2				186	832	8.00		**		**	1.1	13.4				**				**	475	
25-May-93																									
18-Oct-93		93.1	33.7				9.5	372	7.07		697		10	0.31	0.77				2.4				0.62	4	
3-May-94		79.9	31.2				7.8	328	7.24		655		4.2	0.138	0.47				1.6		0.008		1.57	< 2	
21-Oct-94		92.7	35.1				9.2	376	7.18		693		< 1.0	0.153	0.50				1.6		0.018		3.92	8	
29-May-95		88.9	34.2				8.2	363	7.17		665		3.9	0.15	0.98		0.04	3.7			0.1		4.24	4	
11-Oct-95		97.4	35.8				11	391	6.92		701		1.4	0.41	0.61		0.02	4.2			0.03		1.9	< 2	
9-May-96		96.7	37.2				8.9	395	6.96		657		1	0.11	0.3		<0.1	3.4	< 1		0.02		1	< 2	
9-May-96 *		96.5	37.1				8.9	394	6.88		658		< 1	0.09	0.32		<0.1	3.4	< 1		<0.01		2	< 2	
25-Sep-96		90.5	35.9				9.5	374	6.9		683		< 1	0.05	0.4		<0.1	3.7	< 1		0.07				
25-Sep-96 *		90.2	36				9.5	373	7.01		684		< 1	0.06	0.06		<0.1	3.7	< 1		<0.01				
8-May-97		87.4	34.2				12.0	359	6.99		714		< 1	1.11								16	33		
8-May-97 *		87.0	32.6				12.1	351	6.89		712		3	1.09								20	34		
23-Oct-97		105	49.2	7	4.1		11.3	465	7.13		705		< 1	0.15	0.45		<0.1	3.7			0.04		2	12	
16-Apr-98		91.5	37.2				11.0	382	7.23		690		< 1	0.22	0.38		<0.1	3.7	< 1		0.03		7	8	
16-Apr-98 *		91.3	37.5				11.1	382	7.29		689		< 1	0.23	0.36		<0.1	3.7	< 1		0.03		8	6	
21-Oct-98		104	35.5				11.6	406	7.04		722		< 1	1.17	1.37		<0.1	3.3			0.01		8	5	
21-Apr-99	No Flow																								
11-Nov-99		500	176	73.4	41		98.2	451	6.85		1920		49	17.3	19.8		<0.1	<0.1	89				251	710	
11-Nov-99 *		485	160	72.4	45.1		97.6	338	6.88		1950		42	17.3	19.8		<0.1	<0.1	75				303	814	
13-Apr-00		262	107			21.4	77	1095	6.88		1558		14	11.7	10.9		<0.1	<0.1	35		1.55	0.02	549	382	
13-Apr-00 *		222	98.7			24.8	76.9	961	6.91		1499		10	9.13	10.3	1.17	<0.1	<0.1	22		2.14	<0.01	114	323	
17-Oct-00		135	48.9	26	10.5		39	538	6.74		1093		< 1	5.19	7.7	2.51	<0.1	<0.1	30		0.93		21	62	
17-Oct-00 *		125	46.9	23.4	9.57		40.3	505	6.8		1094		< 1	5.41	8.75	3.34	<0.1	<0.1	25		1.33		13	80	
24-Apr-01		175	78.2	9.63	7.2		14.7	759	7.23		757		5	0.89	4.56	3.67	0.7	1							
24-Apr-01 *		164	72.6	9.3	6.9		15.1	708	7.18		759		5	0.96	3.59	2.63	0.6	0.8	7						
3-Oct-01	No Sample																								
18-Apr-02		94.1	37.7	3.8	1.8		10.4	390	6.9		701		< 1	0.09	0.26	0.17	<0.1	4.7							
24-Oct-02		99.7	37.5	5.4	2.7		10	403	7.61		696		< 1	0.08	0.23	0.15	<0.1	4.6	< 0.5		0.01	<0.01	< 1	2	
22-May-03		89.8	32.9	5.8	0.6		13.1	360	7.55		667		< 1	0.06	0.33	0.27	<0.1	3.9	0.7		0.01	<0.01	2	< 2	
30-Oct-03		95.2	36.6	7.4	2.8		10.9	388	8.07		710		< 1	0.19	2.54	2.35	<0.1	4	3						
20-May-04				5.6	2.4		10.1	347	7.28		637		< 1	0.19	0.48	0.29	<0.1	4.6	0.5	0.005		0.07	<0.01	2	3
30-Sep-04		91.2	34	5.5	2.4		9.9	368	7.64		677		< 1	<0.01	0.19	0.18	<0.1	4.5	0.5		0.01	<0.01	2	7	
5-May-05		9.5	87.1	34.6	5.9	2.4	10.4	360	7.16	7.5	684	642	< 1	0.08	0.32	0.24	<0.1	4.2	0.6		0.01	<0.01	< 3	<5	
29-Sep-05		10.8	136	50.7	25	11.3	37.7	549	7.99	7.7	922	833	22	0.65	3.25	2.6	0.6	3	19		0.29	<0.01	19	68	
4-May-06		9.9	95.6	36	7	3.2	12.4	387	7.64	7.5	688	687	< 1	0.54	1.66	1.12	0.1	4.2	4.6		0.07	< 3	11		
20-Sep-06		10	92.1	34.7	7.4	3.3	12.3	373	7.73	7.9	690	691	< 1	0.34	0.57	0.23	<0.1	4.1	1.8		0.02	< 3	5		
10-May-07		9.1	89.7	34	8	3.4	13.3	364	7.78	7.3	650	702	< 1	0.42	0.61	0.19	<0.1	4.1	1.3	< 0.01		< 3	9		
4-Oct-07		10.9	99	35.3	6.5	3	9.9	392	7.43	7.3	576	640	< 1	0.14	0.47	0.33	<0.1	4	< 0.5		0.03	< 3	5		
15-May-08		10.2	102	38.8	8.8	3.8	13.1	416	7.59	7.7	670	680	< 1	0.43	0.69	0.26	<0.1	3.8	1.2	< 0.01		< 3	5		
2-Oct-08		9.8	87.2	31.7	6	2.8	11.4	348	7.99	7.1	627	593	< 1	0.28	0.5	0.22	<0.1	4.2	1.1		0.03		7	< 5	
21-May-09		9.5	95	35.5	8.5	3.9	13.4	384	7.66	7.8	717	669	2	0.66	0.93	0.27	0.2	3.8	1.7		0.02		3	12	
15-Oct-09		9.0	98.1	36.9	8.8	3.9	14	397	6.87	7.7	699	713	< 1	0.91	1.14	0.23	<0.1	3.6	1.6		0.02		4	< 5	
6-May-10		8.4	102	38.5	11.1	3.9	15.9	412	7.89	7.6	741	641	< 1	0.98	1.33	0.35	<0.1	3.5	1.9		0.01	< 3	11		
11-Nov-10		9.8	105	39.7	9.8	3.6	15.4	426	7.16	7.35	735		< 1	0.85	1.15	0.3	<0.1	3.5	1.8		0.02		4	11	
5-May-11		9.5	88.8	34.1	8.3	2.8	14.8	362	7.02	7.3	745	568	< 1	0.91	1.08	0.17	<0.1	3.6	1.5		0.03		5	5	
30-Sep-11		7.0	95.6	37	8.5	3.5	13.8	391	7.62	7.0	741	678	< 1	0.48	0.94	0.46	<0.1	3.4	1.2		0.08		4	32	
19-Apr-12		9.6	77.3	34.4	8.2	3.2	13.6	335	7.63	7.2	700	694	< 1	0.36	0.64	0.28	<0.1	3.5	1.1		0.02		8	5	
3-Oct-12		11.1	96.1	37.2	8.8	3.7	14.5	393	8.02	7.25	698	735	< 1	0.74	1.14	0.40	<0.1	3.2	1.7		0.02	< 3	5		
2-May-13		10.4	104	38.2	11.4	3.9	15.6	417	7.63	7.20	710	680	< 1	0.72	1.25	0.53	<0.1	3.0	2.3		0.04	< 3	8		
3-Oct-13		10.4	92.3	34.8	8.2	3.1	12.9	374	7.52	7.09	649	587	< 1	0.27	0.53	0.26	<0.1	3.4	3.7		0.01	< 3	5		
7-May-14		9.0	88.6	33.0	11.2	3.0	19.7	357	7.74	7.32	667	696	< 1	0.43	0.61	0.18	<0.1	3.1	2.7		0.02	< 3	5		
2-Oct-14		10.6	92.1	34.2	8.4	3.0	13.8	371	7.91	7.33	669	633	< 1	0.19	0.40	0.21	<0.1	3.2	2.7		< 0.01	< 3	5		
6-May-15		10.1	98.1	37.4	9.5	3.2	14.1	399	7.93	7.43	650	630	< 1	0.45	0.64	0.19	<0.1	2.9	5.1		< 0.01	< 3	5		
22-Sep-15		12.0	99.7	37.1	9.0	2.9	13.5	402	7.96	8.14	688	731	< 1	0.28	0.45	0.17	<0.1	2.9	0.9		< 0.01	< 3	5		
4-May-16		10.3	89.2	39.2	10.8	3.1	14.4	384	7.79	7.15	686	740	< 1	0.58	0.81	0.23	<0.1	2.5	0.8		< 0.01	< 3	5		
28-Sep-16		11.1	93.3	35.5	8.7	2.7	12.6	379	7.91	7.34	685	627	< 1	0.24	0.48	0.24	<0.1	2.6	1.1		0.02	< 3	5		
5-Jun-17																									

Manhole MH-8

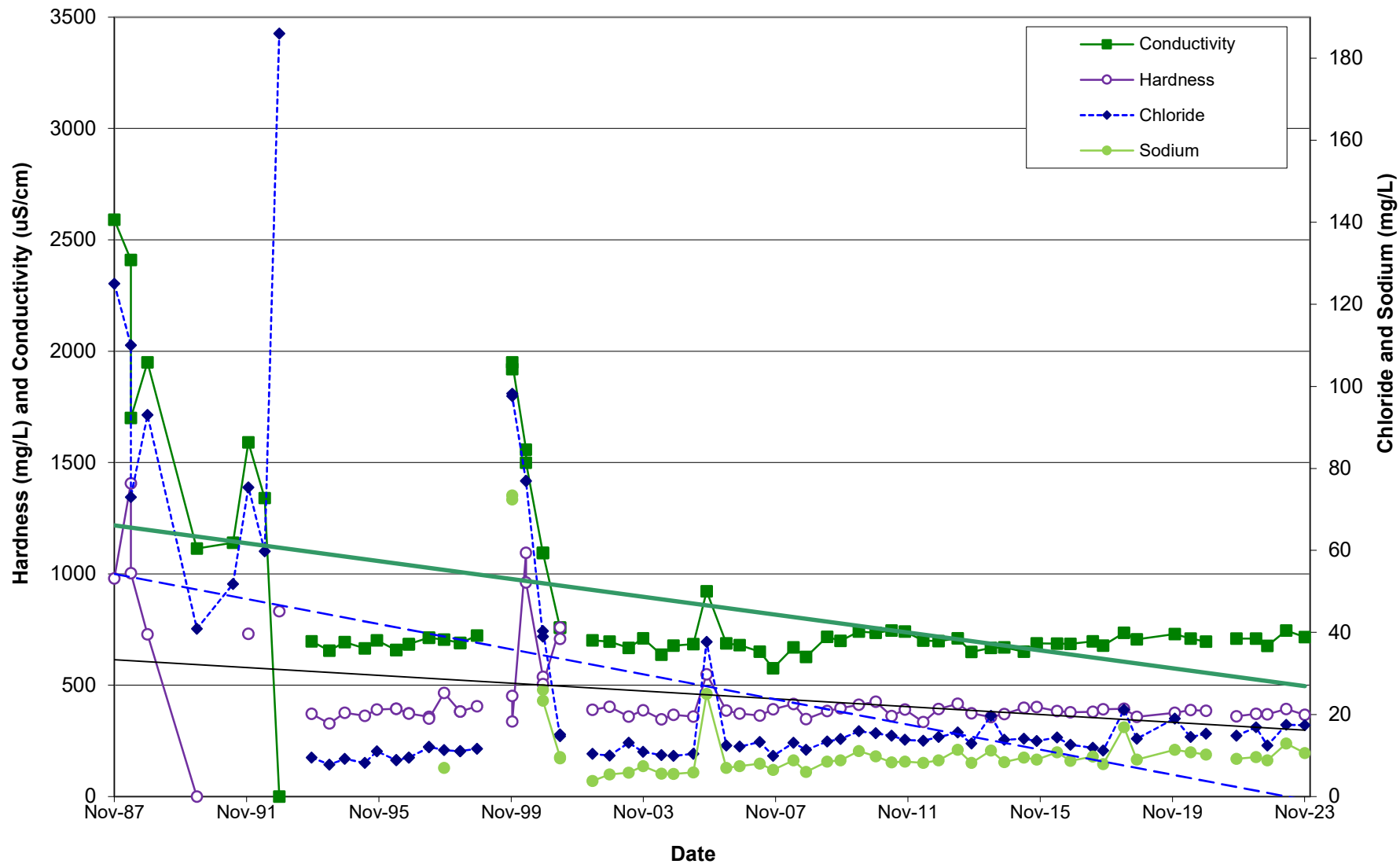

HISTORIC GROUNDWATER QUALITY DATA
Monitoring Well OW-183

DATE	Temp (field) °C	Calcium	Magnesium	Sodium	Potassium	Alkalinity as CaCO3	Sulphate	Chloride	Hardness as CaCO3	pH (field)	Conduct (field)	Iron	Phenols	Ammonia NH3 as N	TKN as N	Organic Nitrogen	Nitrite as N	Nitrate as N	DOC	Magnesium	Total Phosphorus	Arsenic	p-PO4					
OWQGS				200		30-500	500	250	80-100	6.5-8.5	6.5-8.5					0.15	***	10***	5	0.05		0.025***						
18-Jul-83		79.5	40.8	8.9	1.85	296	64	12	367	7.97	690	0.19	<	1	0.045	0.39												
2-Aug-83		84.5	39.6	8.2	1.45	305	70	10.5	371	8.53	700	0.24	<	1	0.040	0.12												
8-Jul-86		70	40	7.5	1.3	292	74.5	11	340	7.78	735	2.05	<	4.0	0.145	0.24		0.01	<	0.01	1.7							
13-Nov-86		18	38.4	9	1.85	150	67.5	11	203	8.14	423	7.4	3.0	0.44	0.85		<	0.01	<	0.01	1.4	0.06						
18-Nov-87		86.2	43.26					12.83	393	7.74				0.9														
19-May-88		40.7	40.75					12.4	270	8.02	540	<											2.7					
2-Nov-88		23.9	39.02					12.8	221	7.94	481	<											2.6					
24-May-89		84.1	44.2	9.6	3.4	336	79	15.5	392	7.55	758	1.32	<	1	0.0007							1.9	0.08					
11-Dec-89		97.2	44.2					13.7	400	8.49	724	<											0.3					
16-May-90		83.3	42.5					16.1	383	7.51	751	<											0.8					
2-Dec-90		86.1	44.8					14.8	400	7.52	757	<											1.1					
3-Jun-91		90	45.1					14.3	415	7.56	764	<											1.4					
19-Nov-91		88.3	48.4					14.2	420	7.5	800	<											1.1					
19-May-92		95.1	51.8					14.0	451	7.47	814	<		5.0									2					
25-Oct-92		91.4	54.1					13.01	451	7.44	808	<		1	0.193								0.9					
26-Oct-92		94.6	53.2					13.3	456	7.47	802	<		1	0.011								0.9					
25-May-93		89.4	44.5					13.4	407	7.51	753	<		1	0.037								0.7					
18-Oct-93		80.9	45.2					12.4	388	7.51	749	<		9.5	0.051								0.8					
3-May-94		90.7	45.4	8.9	1.5			10.1	418	7.87	745	<		1	0.033								0.9					
3-May-94		90.0	45.4	8.5	1.4			10.1	412	7.64	751	<		1	0.032								0.9					
21-Oct-94		80.7	46.7					11.6	394	7.52	739	<		1	0.028								0.9					
29-May-95		80.3	49.2					10	403	7.52	783	<		1	0.04								1.3					
11-Oct-95		67.7	41.7					12.8	341	7.4	625	<		3.1	0.18													
9-May-96		89.3	43					11.3	400	7.28	708	<		1	<0.01								<	1				
25-Sep-96		86.8	47.9					11.4	414	7.34	748	<		1	0.03								1					
6-May-97		80.1	44.1					11.4	382	7.27	741	<		1	0.06								4					
23-Oct-97		89.1	45.0					10.8	408	7.24	736	<		1	0.03								<	1				
23-Oct-97		90.2	45.3					11.0	412	7.42	735	<		1	0.04								<	1				
19-Apr-98		59.2	39.7					12.2	301	7.2	571	<		1	0.01								<	1				
21-Oct-98		80.0	39.4					12.0	362	6.83	672	<		3	0.02								<	1				
21-Apr-99		40.4	22.1					11.8	192	7.47	691	<		1	0.02								<	1				
21-Apr-99		39.6	21.7					11.8	183	7.43	689	<		1	0.03								9					
11-Nov-99		53.5	26.6	5.5	<1.0	217	11.4	17.3	243	7.26	471	14	<	1	<0.01							5	0.099					
11-Nov-99		51.6	24.3	5.2	<1.0	203	5.5	17.6	229	7.23	440	16.9	<	1	<0.01							<	1					
13-Apr-00		40.9	32					12.3	292	7.27	594	15.4	<	1	0.04								0.143					
17-Oct-00		78.7	45.2	7.84	1.96			11.5	383	7.21	700	<		1	0.02								8					
24-Apr-01		78.1	55.9					12.6	428	7.52	713	<		1	0.02								6					
3-Oct-01		38.1	31.7	6.5	1.5			15.3	226	7.27	407	<		1	<0.01								4					
19-Apr-02		86.1	51.2	7.5	1.8			12.6	428	7.21	788	<		1	0.01								3					
24-Oct-02		89.5	51.1	8.1	2.2	330	73	12.2	434	8.17	769	2.38	<	1	0.06						<	0.1	0.67	0.04				
22-May-03		82.2	45.5					10.2	393	7.75	711	<		1	<0.01								0.8					
30-Oct-03		56.8	40.1					12	308	8	565	<		1	0.01	0.11	0.04	<	0.1				10					
20-May-04								13.6	408	7.72	636	<		1	0.04								0.9	0.05				
20-May-04								13.6	410	7.67	654	<		1	0.05								0.9	0.051				
30-Sep-04		44.6	38.6					15	270	7.64	485	<		1	0.03								1.5	0.001				
5-May-05		11.2	25.8	31.6				19.4	7.4	8.0	503	526	<	1	<0.01								3.7	<	0.001			
29-Sep-05		11.6	31.4	37.3				16.3	232	7.89	8.2	490	652	<	1	0.01	0.35	0.34					0.5	<	0.001			
4-May-06		29.6	35.1					17.9	218	7.91	425	<		1	<0.01	0.88	0.87	<	0.1				0.04	0.063				
28-Sep-06		11.1	56.2	45.2				7	330	7.71	8.8	597	449	<	1	0.02	0.49	0.47	<	0.1			0.13	0.0001				
10-May-07	INS																											
4-Oct-07	INS																											
15-May-08	INS																											
2-Oct-08	INS																											
21-May-09	INS																											
19-Oct-09	INS	8.3	35.8	40.7				14.9	257	7.28	8.2	569	742	<	1	0.02	0.48	0.48	<	0.1			0.07	<	0.0001			
6-May-10	INS																											
11-Nov-10	INS																											
18-May-11	INS	11.8	47.4	51.5				12.6	330	7.86	7.5	667	460	<	1	0.04	0.92	0.88	0.1	0.1			0.07	0.0001				
25-Sep-11	INS																											
24-Nov-11		8.9	33.7	46.5				14.0	276	8.00	8.43	566	423	<	1	0.08	<	0.05					<	0.01	0.0002			
26-Apr-12		7.8	59.0	41.9	8.7	1.9	290	36	15.5	320	8.13	7.57	667	435	4.84	<	1	<0.01	0.46	0.46	<	0.1		0.04	0.0001			
4-Oct-12		13.7	15.7	25.5				12.7	158	8.03	8.68	371	480	<	1	0.03	0.36	0.27	<	0.1			4	0.05	<	0.0001		
2-May-13		10.1	11.4	42.5				16.0	203	7.97	8.00	372	314	<	1	0.04	0.27	0.23	<	0.1			0.02	<	0.0001			
3-Oct-13		10.0	10.8	32.5				14.9	160	8.16	8.26	312	281	3	0.22	1.18	0.96	<	0.1				0.13	0.0001				
7-May-14		9.7	15.3	35.4				13.9	194	8.19	8.21	387	308	<	1	0.15	0.63	0.48	<	0.1			0.09	<	0.0001			
2-Oct-14		10.0	10.1	42.8				13.9	201	8.18	8.38	391	317	58	0.79	13.9	13.11	<	0.1				0.40	0.0001				
6-May-15		9.8	12.4	24.2				15.5	131	8.04	7.76	336	337	<	1	0.39	0.7	0.31	<	0.1			0.16	<	0.0001			
22-Sep-15		13.3	11.2	17.3				12.7	99	7.85	8.52	229	429	<	1	0.59	1.2	0.61	<	0.1			0.04	0.0001				
4-May-16		8.28	43					37	19.5	244	8.28	446	<	0.005	<	1	0.03	0.21	0.17	<	0.1			<	0.01	<	0.0001	
28-Sep-16		9.7	16.0	52.4				37	51.4	255	8.06	8.20	522	500	2.41	<	1	0.08	0.24	0.18	<	0.1			<	0.01	<	0.0001
5-Jun-17		9.7	13.3	48.3				22	53.9	232	7.95	7.90	675	502	0.290	5	0.34	0.3					<	0.01	0.0002			
27-Sep-17		10.1	22.1	54.2				20	59.8	8.16	7.62	632	629	3.13	<	1	0.03	0.3	0.21	<	0.05			0.01	0.0002			
15-May-18		9.2	12.9	49.5				8.0	69.5	238	8.38	7.97	538	524	1.05	<	1	0.04	0.2	0.18	<	0.05			0.02	<	0.0001	
3-Oct-18		10.1	17.7	44.5				5.0	77.4	227	8.67	7.05																

Monitoring Well OW1-83

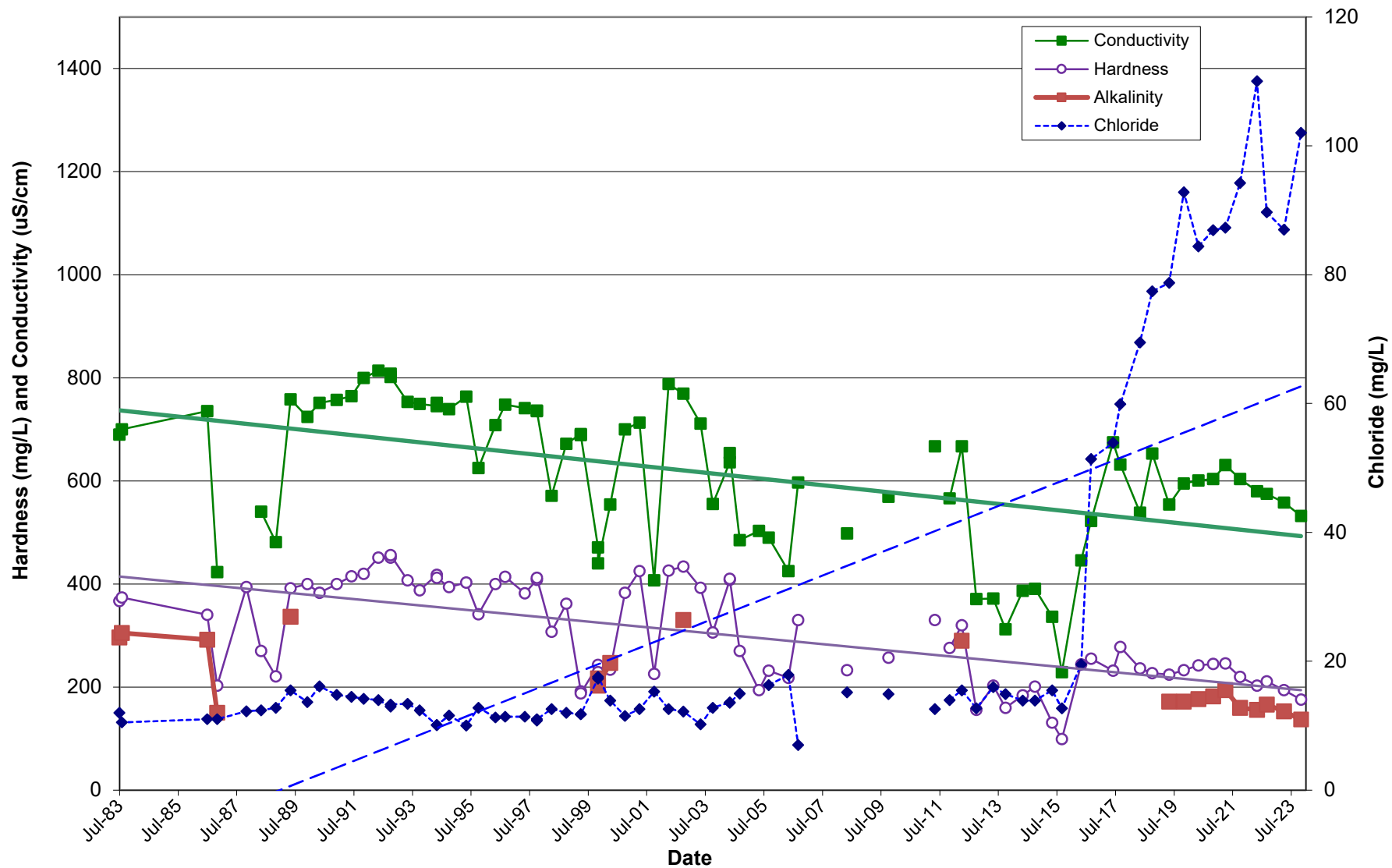

Monitoring Well OW1-83

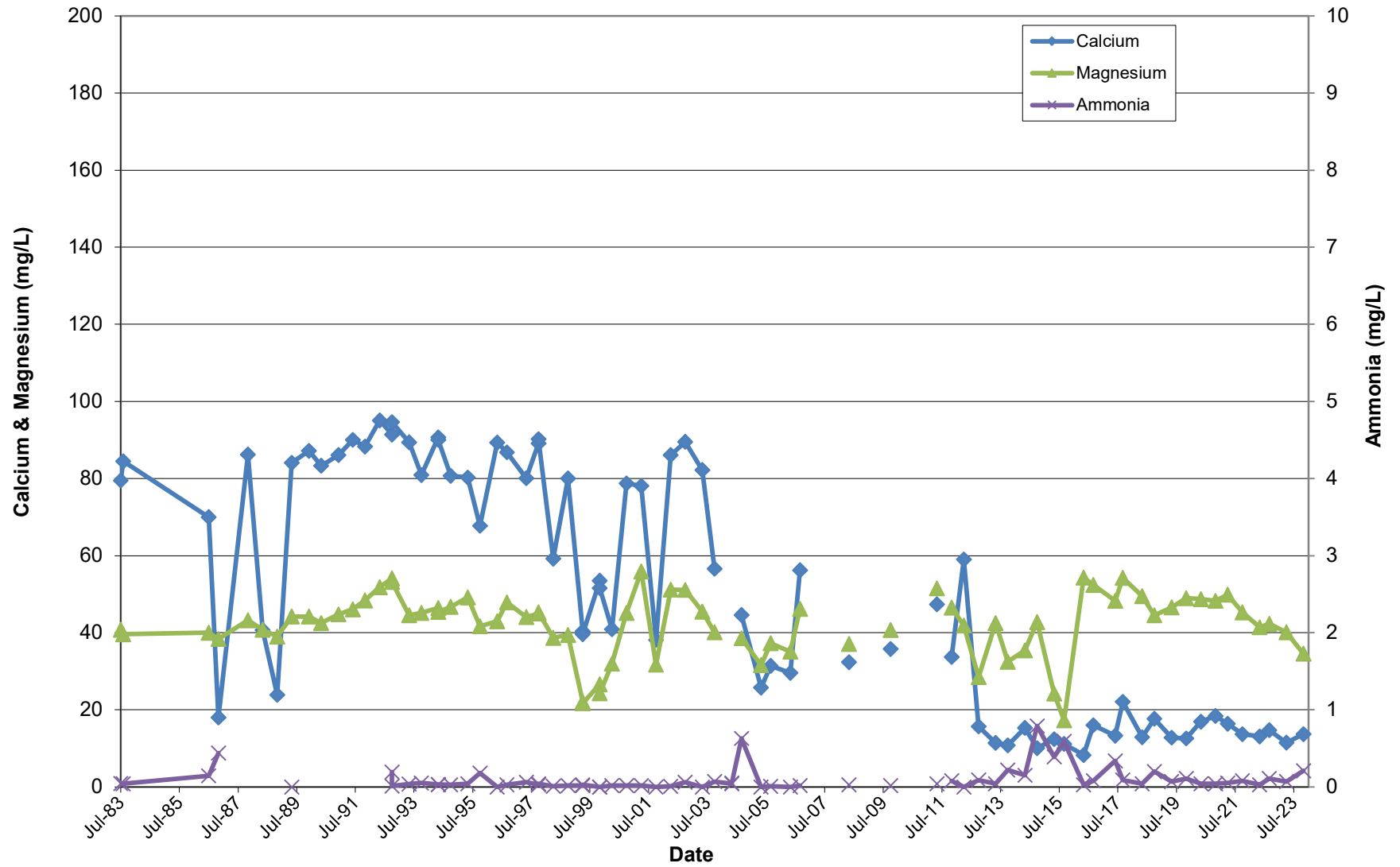

HISTORIC GROUNDWATER QUALITY DATA
Monitoring Well OW2-83

DATE	Temp (field) °C	Calcium	Magnesium	Sodium	Potassium	Alkalinity as CaCO3 30-500	Sulphate 500	Chloride 250	Hardness as CaCO3 80-100	pH 6.5-8.5	pH (field) 6.5-8.5	Conduct (field)	Iron 0.3	Phenols	Ammonia as N	TKN as N	Organic Nitrogen	Nitrite as N	Nitrate as N	DOC	Manganese 0.05	Total Phosphorous	Arsenic 0.025***	o-PO4
18-Jul-83	-	-	-	-	-	-	-	-	-	-	-	-	-	3.5	-	-	-	-	-	5	0.05			
18-Jul-83	72	27	-	-	-	178	116	15	290	8.0	-	430	0.08	-	-	-	-	-	-	-	-	-	-	-
2-Aug-83	55	32.6	8.1	1.65	181	78	11.5	272	7.72	-	-	525	0.06	2.0	0.10	0.10	-	-	-	-	-	-	-	-
9-Jul-86	64	24.4	5.8	1.15	204	5.8	11	261	7.91	-	-	575	17.5	1.0	0.495	0.76	0.01	<0.1	-	1	0.15	-	-	
13-Nov-86	39.5	25.8	6.1	1.2	132	74	10.5	205	7.91	-	-	412	8.2	4.5	0.2	0.67	0.01	<0.1	-	1	-	-	-	
5-May-87	63.5	28.6	-	-	-	-	11	277	7.76	-	-	565	< 1	1.1	1.8	-	-	0.01	0.5	-	7.1	-	-	
19-Nov-87	85.6	34.34	-	-	-	-	8	355	7.84	-	-	< 1	< 1	-	-	-	-	-	-	-	2.1	-	-	
19-May-88	79	35.24	-	-	-	-	8.4	343	8.09	-	-	655	< 1	-	-	-	-	-	-	-	2.4	-	-	
2-Nov-88	58.4	27.44	-	-	-	-	8.9	259	7.44	-	-	533	< 1	-	-	-	-	-	-	-	1.7	-	-	
24-May-89	49.8	28.3	40.2	1.2	204	73.5	8.8	241	7.97	-	-	544	0.4	< 1	0.007	-	-	-	-	-	2.7	0.042	-	
11-Dec-89	41.3	29.1	-	-	-	-	8.9	223	7.92	-	-	444	< 1	-	-	-	-	-	-	-	0.4	-	-	
16-May-90	36.6	25.6	-	-	-	-	9.9	197	7.56	-	-	428	< 1	-	-	-	-	-	-	-	0.5	-	-	
4-Dec-90	48.5	22.4	-	-	-	-	10.7	234	7.52	-	-	439	< 1	-	-	-	-	-	-	-	0.7	-	-	
3-Jun-91	39.8	25.8	-	-	-	-	9.5	206	7.67	-	-	418	< 1	3.0	-	-	-	-	-	-	0.8	-	-	
19-Nov-91	36.6	27.3	-	-	-	-	9.9	204	7.94	-	-	418	< 1	1.0	-	-	-	-	-	-	0.7	-	-	
19-May-92	38.9	29.9	-	-	-	-	9.6	220	7.75	-	-	429	< 1	-	-	-	-	-	-	-	0.8	-	-	
26-Oct-92	75.8	38.0	-	-	-	-	8.3	346	7.52	-	-	615	< 1	3.5	0.008	-	-	-	-	-	0.7	-	-	
25-May-93	42.7	29.8	-	-	-	-	9.1	230	7.63	-	-	449	< 1	0.10	-	-	-	-	-	-	0.3	-	-	
18-Oct-93	52.4	30.7	-	-	-	-	8.9	257	7.49	-	-	485	< 1	0.012	-	-	-	-	-	-	0.5	-	-	
3-May-94	45.5	30.8	6.4	0.9	-	-	8.6	241	7.84	-	-	468	< 1	11.6	0.014	-	-	-	-	-	0.6	-	-	
21-Oct-94	42.4	32.1	-	-	-	-	10.1	238	7.74	-	-	466	< 1	2.1	0.033	-	-	-	-	-	1.0	-	-	
29-May-95	56.9	34.7	-	-	-	-	7.9	285	7.66	-	-	528	< 1	8.9	0.04	-	-	-	-	-	0.8	-	-	
11-Oct-95	38.6	32.8	-	-	-	-	9.9	232	7.71	-	-	439	< 1	8.4	0.12	-	-	-	-	-	-	-	-	
11-Oct-95	38.2	32.2	-	-	-	-	9.9	228	7.72	-	-	438	< 1	10.1	0.18	-	-	-	-	-	-	-	-	
9-May-96	31.8	35.5	-	-	-	-	8.4	225	7.5	-	-	453	< 1	< 0.01	-	-	-	-	-	-	< 1	-	-	
25-Sep-96	30.2	35.5	-	-	-	-	8.9	221	8.04	-	-	417	< 1	0.02	-	-	-	-	-	-	< 1	-	-	
8-May-97	22.8	33.6	-	-	-	-	8.3	195	7.94	-	-	395	< 1	< 0.01	0.16	-	-	-	-	-	3	-	-	
23-Oct-97	27.2	41.5	-	-	-	-	9.3	239	7.85	-	-	403	< 1	< 0.01	-	-	-	-	-	-	3	-	-	
16-Apr-98	22.6	38.7	-	-	-	-	8.4	216	8.21	-	-	398	< 1	< 0.01	-	-	-	-	-	-	< 1	-	-	
21-Oct-98	27.7	28.2	-	-	-	-	8.9	185	7.63	-	-	407	< 1	< 0.01	-	-	-	-	-	-	< 1	-	-	
21-Oct-98	28.2	27.8	-	-	-	-	8.9	185	7.63	-	-	404	< 1	< 0.01	-	-	-	-	-	-	< 1	-	-	
21-Apr-99	54.6	34.3	-	-	-	-	8.8	277	7.71	-	-	550	< 1	< 0.01	-	-	-	-	-	-	< 1	-	-	
11-Nov-99	19.4	30.5	6.9	<1.0	167	19.6	9.8	174	7.94	-	-	375	0.07	< 1	< 0.01	-	-	-	-	-	< 1	0.039	-	
13-Apr-00	28.5	40.9	-	-	-	-	46.7	9.1	239	7.76	-	501	0.56	< 1	< 0.01	-	-	-	-	-	3	0.036	-	
17-Oct-00	48.3	37.3	6.4	1.6	-	-	8.7	274	7.5	-	-	528	< 1	1.11	-	-	-	-	-	-	3	-	-	
24-Apr-01	10.7	35.3	-	-	-	-	7.7	172	8.2	-	-	341	< 1	0.02	-	-	-	-	-	-	1	-	-	
3-Oct-01	14.4	37.1	5.6	1.2	-	-	7.8	138	8.16	-	-	347	< 1	0.03	-	-	-	-	-	-	< 1	-	-	
18-Apr-02	56.4	39.8	6.8	1.5	-	-	8.0	305	7.48	-	-	569	< 1	0.01	-	-	-	-	-	-	< 1	-	-	
24-Oct-02	43.1	44.3	-	-	-	-	8.4	290	8.13	-	-	517	< 1	0.05	-	-	-	-	-	-	0.5	-	-	
24-Oct-02	89.7	50.8	-	-	-	-	12.4	433	8.07	-	-	768	< 1	0.05	-	-	-	-	-	-	< 1	-	-	
22-May-03	37.9	34.1	-	-	-	-	1.8	235	8.10	-	-	425	< 1	< 0.01	-	-	-	-	-	-	0.5	-	-	
30-Oct-03	32.9	38.2	-	-	-	-	8.1	239	8.27	-	-	447	< 1	0.04	0.16	0.12	<0.1	0.1	-	-	10	-	-	
20-May-04	-	48	40.8	-	-	-	7.4	235	8.09	-	-	455	< 1	0.06	-	-	-	-	-	-	< 0.5	0.034	< 0.001	
30-Sep-04	-	48	40.8	-	-	-	7.8	287	8.01	-	-	495	< 1	0.05	-	-	-	-	-	-	< 0.5	< 0.001	< 0.01	
5-May-05	9.4	34.3	39.5	-	-	-	7.1	248	8.08	8.6	430	418	< 1	< 0.01	-	-	-	-	-	-	0.5	< 0.001	< 0.01	
29-Sep-05	10.9	43	43.5	-	-	-	7.1	286	7.95	8.2	463	517	< 1	0.26	0.85	0.59	<0.1	<0.1	-	-	3.2	< 0.001	< 0.01	
4-May-06	13.4	35.1	31.6	-	-	-	7.1	218	8.35	8.6	397	447	< 1	0.11	0.78	0.67	<0.1	0.1	-	-	0.17	0.002	< 0.01	
28-Sep-06	10.5	13.3	41	-	-	-	7.1	202	8.09	8.5	459	557	< 1	0.26	0.36	0.1	<0.1	0.1	-	-	0.03	0.0002	< 0.01	
28-Sep-06	-	17	41	-	-	-	7.1	203	8.02	8.0	460	460	< 1	0.27	0.47	0.2	<0.1	0.1	-	-	0.03	0.0001	< 0.01	
10-May-07	10.2	34.6	38.6	-	-	-	8.0	253	8.04	8.0	502	455	< 1	0.06	0.15	0.09	<0.1	<0.1	-	-	0.5	0.03	< 0.0001	
4-Oct-07	12.3	23.3	41.5	-	-	-	6.9	229	7.78	8.3	481	506	< 1	< 0.01	0.25	0.24	<0.1	<0.1	-	-	0.05	< 0.0001	< 0.01	
4-Oct-07	24	41.4	-	-	-	-	6.9	230	7.92	-	-	469	< 1	0.01	0.25	0.24	<0.1	<0.1	-	-	0.04	0.0001	< 0.01	
15-May-08	10.9	53.1	41.3	-	-	-	6.5	303	7.66	8.3	529	508	< 1	0.06	0.25	0.19	<0.1	<0.1	-	-	0.03	0.0002	< 0.01	
2-Oct-08	10.6	10.7	40.6	-	-	-	6.4	194	8.54	8.0	432	467	< 1	0.04	0.13	0.09	<0.1	<0.1	-	-	0.03	< 0.0001	< 0.01	
21-May-09	10.9	11.1	43.4	-	-	-	6.5	206	7.99	-	-	540	469	< 1	0.02	<0.05	<0.03	<0.1	<0.1	-	0.03	< 0.0001	< 0.01	
15-Oct-09	10.4	42.9	41.5	-	-	-	6.9	278	7.29	9.0	550	484	< 1	< 0.01	0.07	0.06	<0.1	0.1	-	-	0.01	0.0002	< 0.01	
8-May-10	7.8	17.8	38.4	-	-	-	5.9	202	8.19	6.6	405	454	< 1	0.03	0.22	0.19	<0.1	0.1	-	-	0.02	0.0001	< 0.01	
11-Nov-10	14.5	45.2	-	-	-	-	6.9	222	7.66	-	-	477	< 1	6	0.55	0.52	<0.1	0.1	-	-	0.05	0.0001	< 0.01	
11-Nov-10	13.7	45.3	-	-	-	-	6.8	220	7.72	-	-	473	< 1	5	0.56	0.39	<0.1	0.1	-	-	0.04	0.0001	< 0.01	
5-May-11	8.9	8.40	40.2	-	-	-	36	6.2																

Monitoring Well OW2-83

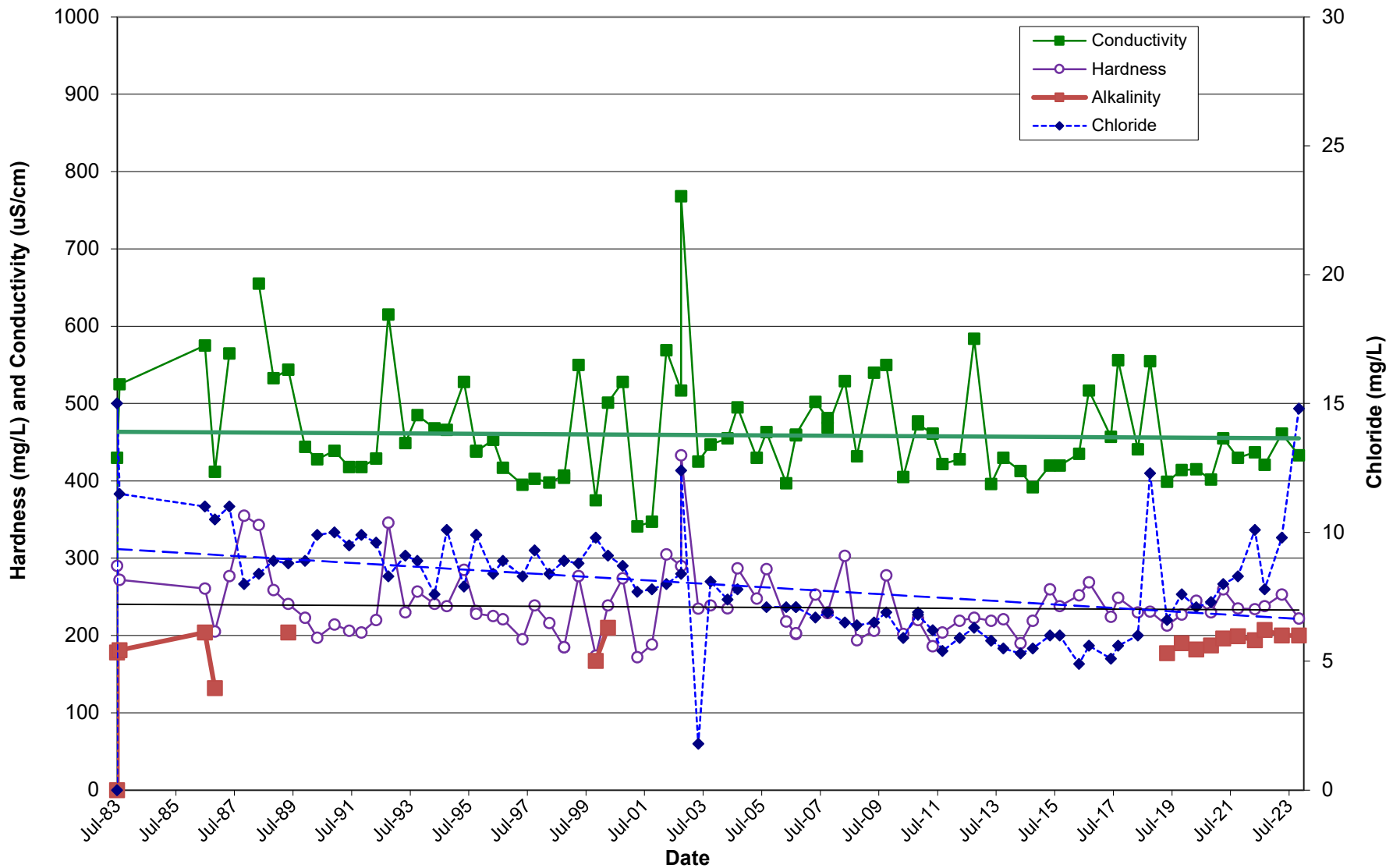

HISTORIC GROUNDWATER QUALITY DATA
Monitoring Well OW3-83

DATE	Temp (field) °C	Calcium	Magnesium	Sodium	Potassium	Alkalinity as CaCO3	Sulphate	Chloride	Hardness as CaCO3	pH	pH (field)	Conduct.	Conduct. (field)	Iron	Phenols	Ammonia as N	TKN as N	Organic Nitrogen	Nitrite as N	Nitrate as N	DOC	Magnesium	Total Phosphorous	Arsenic	o-PO ₄			
ODWQS				200		30 - 500	500	250	80 - 100	6.5 - 8.5	6.5 - 8.5			0.3				0.15	1***	10***	5	0.05		0.025***				
18-Jul-83		79	26.8		4.6	2.40	263	49	19.5	308	7.56			605				13.06	5.5	0.035	0.62							
2-Aug-83		84.5	37.4	8.6	1.65	343	36.5	5.0	375	7.71			670	0.38	<	1	0.030	0.13										
5-May-87		42.5	39.8					12	270	7.75			575	<	1	1.4	2.14		0.03	0.5								
24-May-89		75.7	34.1	6.96	2	311	34	8.3	330	7.34			634	10.2	<	1	0.006					5.4		2.5	0.043			
11-Dec-89		36.8	19.4					12.3	171	7.31			334	<	1													
18-May-90		49.9	25.6					9.9	226	7.08			462	<	2													
4-Dec-90		52.2	24.5					9.7	231	7.25			460	<	1													
3-Jun-91		60.6	30.5					9.2	277	7.23			523	<	1													
19-Nov-91		67.1	31.5					9.3	298	7.29			557	<	1.5													
19-May-92		52.8	30.4					10.1	257	7.28			481	<	1							840*						
26-Oct-92		78.3	34.6					8.0	338	7.43			587	<	1	0.012												
25-Jun-93		73.1	34.1					8.1	325	7.45			579	<	6.0	0.029												
18-Oct-93		78.1	34.3					7.6	337	7.43			611	<	2.0	0.038												
3-May-94		35.1	26.1	2.9	0.8			10.6	195	7.52			398	<	15.4	0.083												
21-Oct-94		61.3	30.0					10.1	277	7.27			505	<	1	0.029												
29-May-95		61.4	33.3					7.8	291	7.46			511	<	3	0.04												
11-Oct-95		63	30					10.4	281	7.13			512	<	1	0.17												
8-May-96		39.8	28.8					8.1	218	7.23			489	<	1	0.02												
25-Sep-96		41.9	31.6					10.3	235	7.31			427	<	1	0.04												
8-May-97		33.9	31.9					8.5	216	7.63			407	<	1	0.02												
23-Oct-97		31.3	37.7					9.1	233	7.30			457	<	1	0.04												
16-Apr-98		39.5	38.0					7.7	255	7.69			473	<	1	0.01												
21-Oct-98		48.8	32.7					7.9	456	7.33			468	<	1	0.08												
21-Apr-99		40.6	26.6					9.6	211	7.9			446	<	1	0.02												
11-Nov-99		40	27.3	9.6	<1.0	214	<1.0	12.1	212	7.33			425	6.83	<	1	0.01						4	0.07				
13-Apr-00		51.7	35.7			219	3.6	12.5	276	7.9			447	0.3	<	1	<0.01						4	0.057				
17-Oct-00		47.7	27.8					13.3	234	7.31			466	<	1	0.06												
24-Apr-01		59.5	39.4					12.2	311	7.77			529	<	1	0.02												
5-Oct-01		63.1	37.5	4.4	1.3			12.8	312	7.75			516	<	1	0.05												
18-Apr-02		60	43.5	5.6	1.6			21.7	404	7.35			725	<	1	0.02												
22-Oct-02		85.1	47.9					23.2	410	8.08			712	<	1	0.07												
22-May-03		82.6	42.9					12.6	383	7.78			664	<	1	<0.01												
30-Oct-03		80.8	44.1					17.5	383	8.07			595	<	1	0.11	0.25	0.14	<0.1	0.1								
20-May-04								14.4	361	7.69			600	<	1	0.07							0.5	0.049			0.001	<0.01
30-Sep-04		70.2	43.4					14.4	354	7.79			638	<	1	0.07							0.7				0.001	<0.01
5-May-05		7.8	59	43.1				325	7.7	8.2	525	572		<	1	0.01											<0.01	<0.01
29-Sep-05		11.5	83.7	45.1			14	394	7.68	8.8	691	690		<	1	0.05	0.19	0.14				3				<0.001	<0.01	
4-May-06		9.3	83.5	45.7			11.6	396	7.75	7.6	697	688		<	1	<0.01	1.17	1.16	<0.1	<0.1						0.1	0.002	
28-Sep-06		11.6	66.8	42			11.4	340	7.6	8.2	628	666		<	1	0.01	0.11	0.1	<0.1	<0.1						<0.01	0.0002	
10-May-07		8.2	58.6	44.7			11.8	331	8	7.8	535	575		<	1	0.01	0.1	0.09	<0.1	<0.1						<0.01	0.0004	
4-Oct-07		14.7	51.9	42.2			14.2	303	7.43	8.3	586	628		<	1	<0.01	0.15	0.14	<0.1	<0.1						<0.01	0.0002	
15-May-08		8.5	65.1	43			14.3	339	7.06	7.9	655	652		<	1	<0.01	0.2	0.19	<0.1	<0.1						0.02	0.0033	
8-Oct-08		10.9	66.6	43.1			14.8	344	7.85	7.3	646	628		<	1	0.01	0.13	0.12	<0.1	<0.1						0.02	<0.0001	
21-May-09		10.3	23.9	46.4			13.8	251	7.19	8.3	682	587		<	1	0.01	0.13	0.12	<0.1	<0.1						0.01	0.0002	
15-Oct-09		11.7	13.1	14.3			14.9	386	7.13	8.3	681	593		<	1	<0.01	0.09	0.08	<0.1	<0.1						0.02	0.0002	
6-May-10		8.0	29.1	41.4			14.1	243	7.71	8.0	634	501		<	1	0.02	0.14	0.12	<0.1	<0.1						0.02	0.0001	
11-Nov-10		10.3	22.6	46.2			13.3	247	7.37	7.6	542	539		2	0.04	<0.05	<0.01	<0.1	<0.1							0.02	0.0003	
5-May-11		8.0	31.3	43.8			31	11.8	258	7.69	7.6	627	516		<	1	0.02	0.09	0.07	<0.1	<0.1					0.02	0.0001	
29-Sep-11		13.0	28.2	41.7			11.9	242	7.79	7.7	648	577		3	0.04	0.46	0.42	<0.1	<0.1							0.06	0.0002	
19-Apr-12		9.2	35.7	46.2			14.7	279	7.90	7.6	640	653		<	1	<0.01	0.09	0.09	<0.1	<0.1						<0.01	<0.0001	
4-Oct-12		13.1	70.6	46.8			15.3	369	7.99	7.90	680	735		<	1	<0.01	0.10	0.10	<0.1	<0.1						0.01	0.0002	
2-May-13		8.9	29.3	47.7			14.0	270	8.03	7.27	543	621		<	1	<0.01	0.19	0.19	<0.1	<0.1						0.02	<0.0001	
3-Oct-13		12.3	73.5	43.5			12.6	362	7.95	7.62	603	573		<	1	0.02	0.23	0.21	<0.1	<0.1						0.02	0.0006	
7-May-14		7.1	68.1	42.2			13.6	344	8.13	7.73	669	603		<	1	0.04	0.08	0.04	<0.1	<0.1						<0.01	0.0005	
7-May-14 **			68.4	42.5			13.5	345	8.11				641	<	1	<0.01	0.07	0.06	<0.1	<0.1						<0.01	0.0006	
2-Oct-14		12.3	46.0	43.8			14.4	295	7.98	7.72	572	629		<	1	0.59	1.33	0.74	<0.1	<0.1						0.11	0.0002	
6-May-15		8.3	44.9	38.6			13.8	271	8.07	7.74	558	574		<	1	1.10	1.1									0.11	0.0004	
22-Sep-15		12.9	84.5	45.3			12.4	397	7.98	8.45	593	682		4	1.07	0.6		<0.1	<0.1							0.05	0.0006	
4-May-16		8.9	41.5	49.5			36	10.6	307	8.09	7.74	642	646	0.662	<	1	0.06	0.2	0.14	<0.1	<0.1					<0.01	<0.0001	
28-Sep-16		13.8	49.6	40.7			31	10.7	291	8.06	7.79	616	561	0.559	<	1	0.10	0.42	0.32	<0.1	<0.1					<0.01	<0.0001	
5-Jun-17		10.0	68.5	44.8			29	9.8	355	8.02	7.60	643	600	<0.005	<	5	0.06	0.2	0.14	<0.05	<0.05					<0.01	<0.0001	
27-Sep-17		13.0	38.1	41.5			21	10.2	266	8.22	7.21	581	465	0.177	<	1	0.08	0.5	0.42	<0.05	<0.05					0.01	0.0001	
15-May-18		9.0	30.1	42.5			25	13.3	250	8.19	7.53	552	524	0.008	<	1	0.07	2.1	2.03	<0.05	<0.05					0.29	0.0002	
3-Oct-18		12.3	15.3	44.7			35	6.3	222	8.20	7.52	471	479	0.016	<	4	0.26	0.8	0.54	<0.05	<0							

Monitoring Well OW3-83

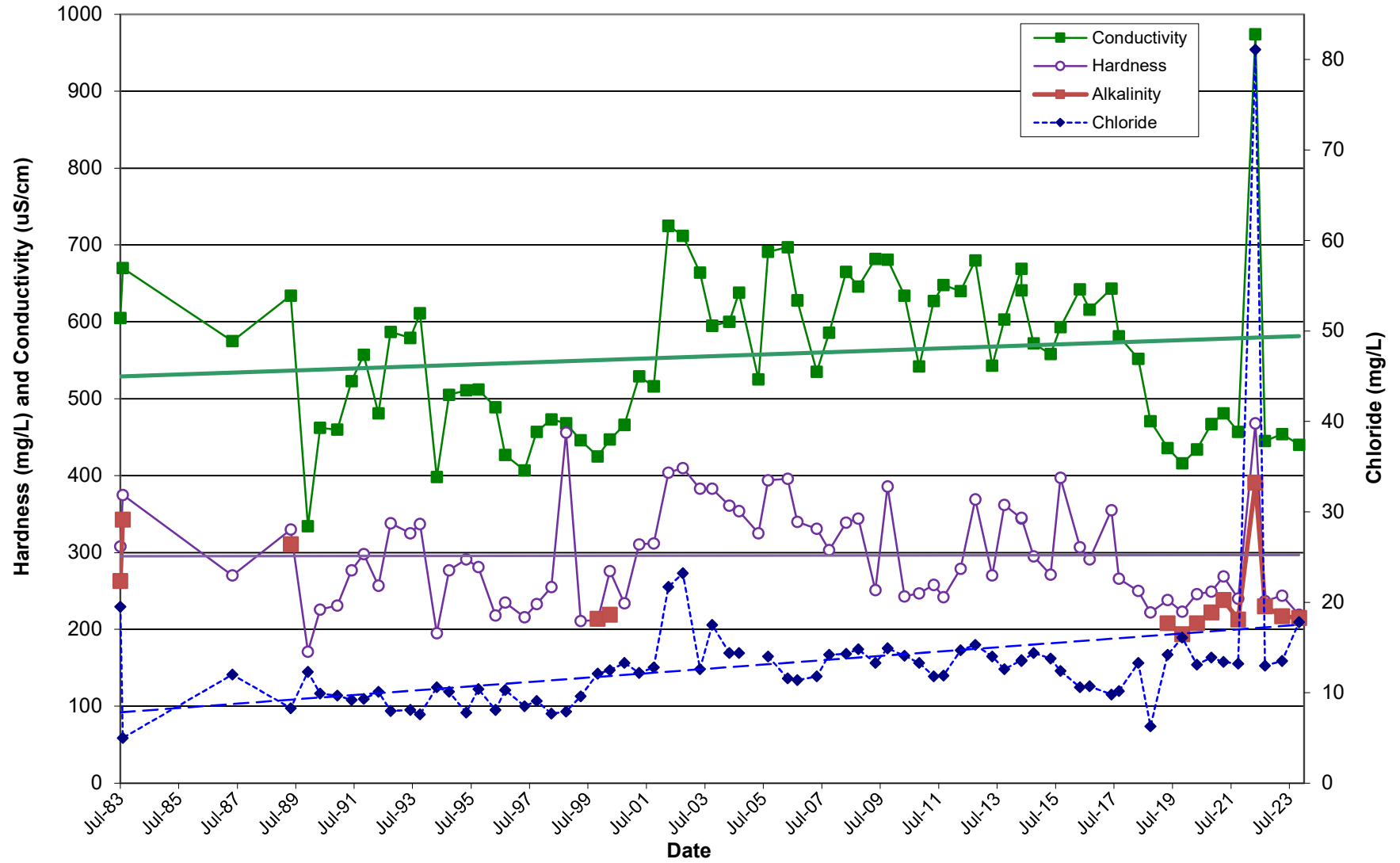

HISTORIC GROUNDWATER QUALITY DATA
Monitoring Well OW4-83

DATE	Temp (field) °C	Calcium	Magnesium	Sodium	Potassium	Alkalinity as CaCO3 30 - 500	Sulphate 500	Chloride 250	Hardness as CaCO3 80 - 100	pH 6.5 - 8.5	pH (field) 6.5 - 8.5	Conduct. Conduct. (field)	Iron 0.3	Phenols	Ammonia as N	TKN as N	Organic Nitrogen	Nitrite as N	Nitrate as N	DOC	Manganese	Total Phosphorous	Arsenic	o-PO ₄
ODWQS				200													0.15	1***	10***	5	0.05		0.025***	
18-Jul-83		56	37.8	9.6	2.15	277	37	6.5	296	8.02		570	1.2	15.0	0.080		0.75							
2-Aug-83		78.5	23.6	3.5	1.6	245	44	13	293	7.05		560	3.58	3.0	0.045		0.28							
6-Jul-86		62.5	38.6	7	1.4	317	34	5.5	315	7.88		700	4.25	3.0	0.305	0.4		0.01	<0.01					
13-Nov-86		17	35.6	7.9	1.54	175	32.5	5	168	8.15		374	4.15	1.0	0.175	1.24		0.01	<0.01			0.057		
5-May-87		72	37.6					7	335	7.72		690		< 1	1.4			0.01	<0.01					
19-Nov-87		84.3	40.26					6.8	377	7.73				< 1							2.6			
19-May-88		81.7	38.3					6.4	362	7.97		690		< 1							3.5			
2-Nov-88		76.5	36.5					6.9	342	7.56		682		< 1							3			
24-May-89		77.5	38.9	18.1	1.3	340	36	5.5	354	7.41		670	1.88	< 1	0.023						0.016			
11-Dec-89		78.7	38.5					5.2	355	7.47		656		< 1										
16-May-90		76.9	35.8					5.4	340	7.52		665		< 4.0							0.6			
4-Dec-90		95.6	39.7					4.8	403	7.53		635		< 1							0.5			
3-Jun-91		32.2	41.5					5.3	251	8.08		381		< 1							0.9			
19-Nov-91		72.9	39.7					4.9	342	7.47		645		< 1							0.7			
19-May-92		83.6	43.0					5.1	386	7.39		679		< 1										
19-May-92 *		70.6	42					5.4	350	7.46		630		< 1							0.5			
26-Oct-92		79	42.1					4.4	371	7.42		685		< 1	0.140						0.5			
25-May-93		82.5	38.3					4.6	364	7.53		666		< 1.0	0.026						0.3			
18-Oct-93		78.4	38.5					4.8	355	7.52		666		< 1	0.031						0.6			
3-May-94		79.6	37.6	7.3		1.3		4.8	354	7.64		667		< 5.6							0.6			
21-Oct-94		72.2	40.6					4.8	348	7.47		671		< 1	0.060						0.6			
21-Oct-94 *		76.5	40.4					4.7	358	7.47		680		< 1	0.042						0.7			
29-May-95		77.1	41.5					4	364	7.6		672		< 7.3	0.09						1.1			
29-May-95 *		73.6	42.3					4.1	358	7.64		669		< 3.7	0.08						1			
11-Oct-95		73.7	41.8					4.2	356	7.55		669		< 1	0.13									
11-Oct-95		70.6	41.6					4.3	348	7.57		667		< 1	0.24									
9-May-96		51.4	43.4					4.5	307	7.58		521		< 1	<0.01						< 1			
25-Sep-96		42.1	39.8					4.7	269	7.54		517		< 1	0.09						< 1			
8-May-97		63.8	39.1					4.3	320	7.43		614		< 1	0.02						< 1			
23-Oct-97		43.8	51.4					5.9	321	7.51		567		< 1	0.03						< 1			
16-Apr-98		43.5	46.2					5.0	299	7.79		539		< 1	0.01						< 1			
21-Oct-98		37.2	41.3					5.0	263	7.44		551		< 1	0.05						< 1			
21-Apr-99		29.5	40.6					5.6	241	7.92		510		< 1	0.03			<0.1	<0.1		13			
11-Nov-99		31.3	45.8	8.4	1.9	266		7	260	7.84		515	0.53	< 1	0.01						12	0.078		
13-Apr-00		53.5	38.9			295	23.4	5.8	294	7.62		602	0.84	< 1	<0.01						0.038			
17-Oct-00		49.5	47.1					5.9	317	7.61		585		< 1	<0.01									
24-Apr-01		15.9	56.1					4.8	270	7.82		544		< 1	0.01						5			
24-Apr-01 *		15.2	57.5					4.8	274	7.81		544		< 1	0.02						3			
3-Oct-01		62.2	49.7	8.8	2.2			5.7	357	7.64		680		< 1	<0.01						< 1			
3-Oct-01 *		70.2	44.1	16.2	4.3			5.8	357	7.56		625		< 1	<0.01						< 1			
18-Apr-02		68.5	49.1	8.3	2.3			5.8	373	7.49		625		< 1	<0.01						< 1			
22-Oct-02		79.4	46.7					5.4	390	8.1		650		< 1	0.04									
22-May-03		35.6	43.3					8.4	267	7.85		502		< 1	<0.01						0.6			
30-Oct-03		87.8	40.7					5.3	387	8.01		674		< 1	0.03	0.06	0.03	<0.1	<0.1					
20-May-04								5.9	391	7.5		632		< 1	0.04						< 0.5	0.05	<0.001	<0.01
30-Sep-04		68.7	46.2					6.2	362	7.79		618		< 1	0.04						< 0.5		<0.001	<0.01
5-May-05		10.2	13.2	46.6				225	8.02	8.0	416	648		< 1	<0.01				<0.1	<0.1	< 0.5		<0.001	<0.01
29-Sep-05		9.2	58.5	43.1				6	324	7.89	9.5	490	613		< 1	0.02	0.30	0.28		<0.1	<0.1	5.4	<0.001	<0.01
4-May-06		10.6	78.3	46.7				7.1	388	8	7.9	652	663		< 1	<0.01	0.38	0.37	<0.1	<0.1		<0.01	0.005	
28-Sep-06	DRY																							
10-May-07		9.9	28.3	44.3				6.5	253	7.98	8.1	480	469		< 1	<0.01	0.06	0.05	<0.1	<0.1		<0.01	0.0003	
4-Oct-07		12.7	25	47.6				6.5	258	7.66	8.4	491	578		< 1	<0.01	0.17	0.16	<0.1	<0.1		0.16	<0.0001	
15-May-08		18.2	49					6.4	247	7.4		503		< 1	<0.01	2.79	2.78	<0.1	<0.1		0.17	0.0002		
2-Oct-08		28	45.4					7.3	257	8.27	7.7	483	594		< 1	<0.01	0.1	0.09	<0.1	<0.1		0.03	<0.0001	
21-May-09		10.3	49					7	243	7.42		486		< 1	0.02	<0.05	<0.03	<0.1	<0.1					
15-Oct-09		15.7	49.5					7.8	257	7.46		540		< 1	<0.01	<0.05	0.04	<0.1	<0.1		<0.01	0.0002		
6-May-10		17.9	44.8					9.1	229	7.83		630		< 1	<0.01	<0.05	<0.04	<0.1	<0.1		0.02	<0.0001		
11-Nov-10		23.6	53					8.6	277	7.57		487		< 2	<0.01	<0.05	<0.04	<0.1	<0.1		<0.01	<0.0001		
5-May-11		13.7	45.3				12	8.3	221	7.94		462		< 1	<0.01	0.23	<0.23	<0.1	<0.1		<0.01	<0.0001		
29-Sep-11		19.0	47.9					8.5	244	8.07		499		< 3	<0.01	0.22	<0.22	<0.1	<0.1		0.05	<0.0001		
19-Apr-12		14.8	52.0					9.8	251	8.21		469		< 1	<0.01	0.14	0.14	<0.1	0.1		0.02	<0.0001		
19-Apr-12 *		14.5	51.5					9.8	248	8.23		462		< 1	<0.01	0.08	0.08	<0.1	<0.1		0.02	<0.0001		
4-Oct-12		11.9	18.5	52.4				9.4	262	8.23	8.09	458	712		< 1	<0.01	0.09	0.09	<0.1	<0.1		0.01	<0.0001	
2-May-13		13.7	15.4	51.5				8.9	250	8.26	7.73	420	569		< 1	<0.01	0.12	0.12	<0.1	<0.1		<0.01	<0.0001	
3-Oct-13		22.6	50.7					8.3	265	8.20		446		< 1	<0.01	0.07	0.07	<0.1	<0.1					
7-May-14		14.1	16.9	49.2				8.6	245	8.38	8.29	454	474		< 1	<0.01	<0.05	<0.05	<0.1	<0.1		<0.01	<0.0001	
2-Oct-14		11.5	22.3	49.4				9.0	259	8.28	8.37	454	461		< 1	<0.01	0.11	0.11	<0.1	<0.1		0.01	<0.0001	
6-May-15		15.7	14.1	51.3				18.6	246	8.23	8.48	422	435		< 1	<0.01	0.22	0.2	<0.1	<0.1		<0.01	<0.0001	
22-Sep-15		18.5	15.4	43.2				71.6	216	8.19	8.73	536	555		< 1	0.08	0.4	0.32	<0.1	<0.1		0.01	<0.0001	
4-May-16		10.8	43.0	39.5			13	96.5	270	8.26	8.26	746	909	0.014	< 1	0.25	0.5	0.25	<0.1	<0.1		<0.01	<0.0001	
28-Sep-16		11.9	57.0	29.4				7	142	8.06	7.77	1110	1081	0.037	23	2.13	4.24	2.11	<0.1	0.1		<0.01	0.0001	
5-Jun-17		10.1	67.8	23.3																				

Monitoring Well OW4-83

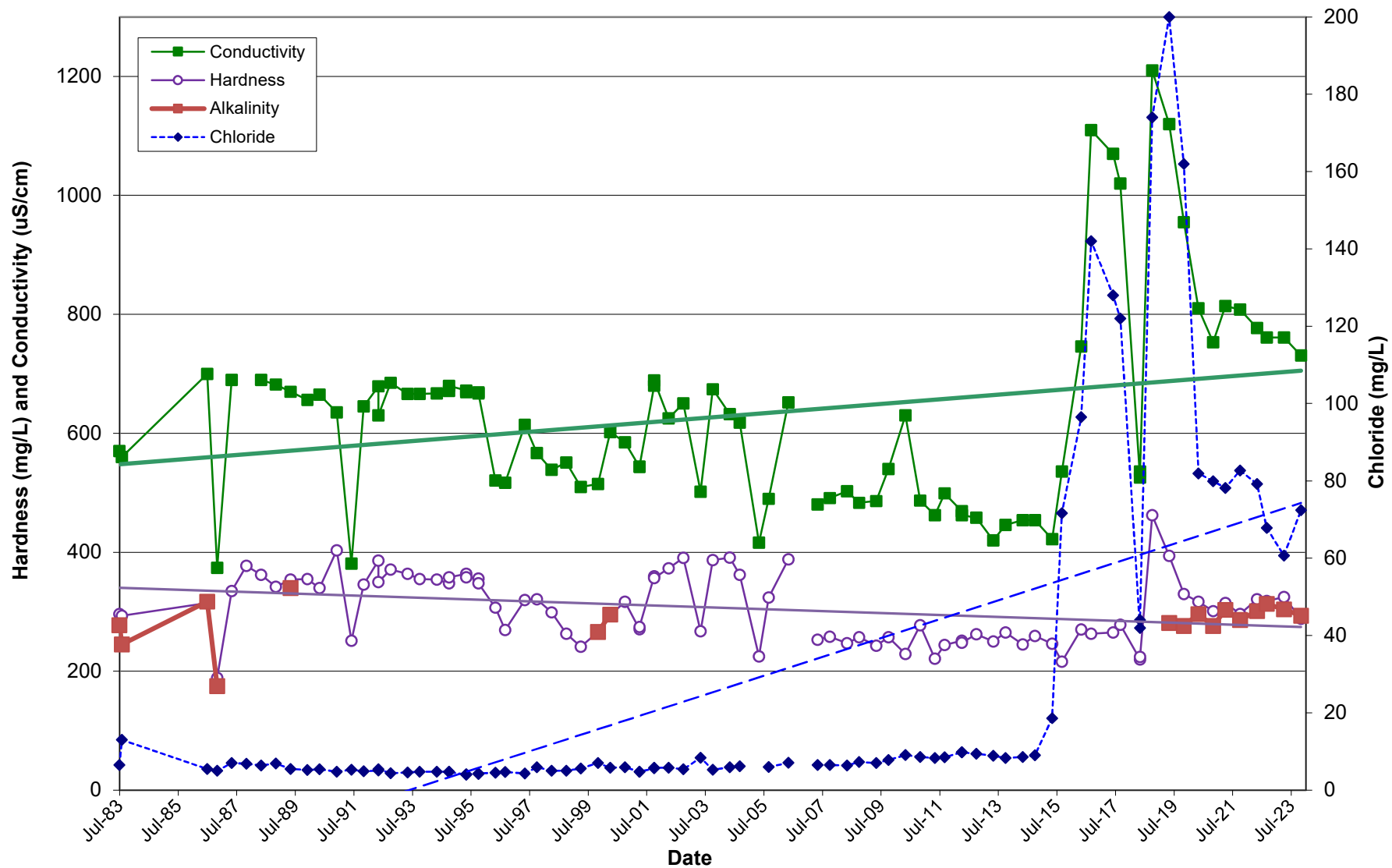

HISTORIC GROUNDWATER QUALITY DATA
TH1-82

DATE	Temp (field) °C	Calcium	Magnesium	Sodium	Potassium	Alkalinity as CaCO3 30-500	Sulphate 500	Chloride 250	Hardness as CaCO3 80-100	pH (field) 6.5-8.5	Conduct. (field)	Iron	Phenols	Ammonia NH3 as N	TKN as N	Organic Nitrogen	Nitrite as N	Nitrate as N	DOC	Magnesium	Total Phosphorus	Arsenic	o-PO4	
18-Jul-83		136	53.0	3.7	2.80	358	178	2.0	558	7.70	945	8.35	18.0	0.295	0.09	0.15	1***	10***	5	0.05		0.025***		
2-Aug-83		135	53	3.5	2.60	354	195	1.5	556	7.40	940	1.18	1.5	0.200	0.41									
9-Jul-86		190	66	1	3.1	313	480	1	747	7.75	1260	7.6	< 1	1.17	1.6			0.01	2	4.3	0.075			
13-Nov-86		162	51	3.4	4.2	429	215	1	615	7.64	1000	7.1	< 1	1.2	1.24			0.04	0.1	2	0.053			
5-May-87		125	45						1	498	7.44	920	< 1	1.4	2.12			0.01	0.5	10.5				
15-Nov-87		139.4	45.34					0.65	535	7.81			< 1							5.1				
19-May-88		112.4	35.1					0.6	426	7.85	765		< 1							4.9				
2-Nov-88		117.2	38.9					1.1	453	7.23	850		< 1							5.5				
24-May-89		107	37.7	2.83	2.5	386	68.5	0.8	423	7.17	782	5.1	< 1	1.2					4.8	0.11				
11-Dec-89		129	40.2					1.9	488	7.23	853		< 1							5.8				
16-May-90		96.9	29.5					1	353	7.17	694		< 1							3.9				
4-Dec-90		95	26.8					0.9	348	7.25	648		< 1							5.9				
3-Jun-91		104	31.3					1.8	389	7.27	708		< 1							4.1				
19-Nov-91		121	37.6					0.7	457	7.14	811		< 1							6.3				
18-May-92		105	35.3					1.1	408	7.12	745		< 1							4.8				
28-Oct-92		130	37.2					0.4	478	7.12	799		< 1	5.0	0.002					5.6				
25-May-93		115	31.2					0.6	417	7.15	745		< 1	1	0.429					2.7				
25-May-93	*	113	30.5					0.6	410	7.19	738		< 1	1.5	0.431					3.0				
18-Oct-93		129	26.3					1	472	7.49	816		< 1	2	0.357					4.8				
5-May-94		96.6	23.2	0.7	1			0.7	337	7.43	607		< 1	1	0.190					4.0				
21-Oct-94		133	42.2					1.1	508	7.41	880		< 1	1	0.220					5				
29-May-95		126	33.2					0.5	454	7.18	766		< 1	7.2	0.04					3.9				
11-Oct-95		138	44.2					0.5	528	7.31	925		< 1	0.26										
9-May-96		104	24.3					2.1	360	7.07	509		< 1	0.01						1				
9-May-96	*	106	24.2					2.2	364	7.04	590		< 1	0.01						1				
25-Sep-96		148	37.2					2.1	525	7.10	953		< 1	0.05										
25-Sep-96	*	148	50.5					2.1	578	7.17	936		< 1	0.06						1				
8-May-97		81.6	18.5					1.7	281	7.07	530		< 1	0.04										
8-May-97	*	86.8	19.3					1.7	296	7.10	530		< 1	0.04						4				
23-Oct-97		131	42.1					3.3	601	6.97	787		< 1	0.06						1				
16-Apr-98		101	33.8					1	349	7.07	600		< 1	0.02						6				
21-Oct-98		129	32.7					1.4	457	6.77	826		< 1	0.06						1				
21-Apr-99		131	29.1					1	447	7.26	819		< 1	0.02						2				
11-Nov-99		161	33.6	2.8	1.2	405	159	1.9	541	6.79	963	6.21	< 1	0.01					13	0.202				
15-Apr-00		157	37.9			385	144	0.9	588	7.06	853	5.9	< 1	< 0.01					5	0.166				
17-Oct-00		107	19.7					2.8	689	6.85	1121		< 1	0.03	0.84	0.81				10				
24-Apr-01		112	26.5					1.1	389	7.24	690		< 1	< 0.01					6					
3-Oct-01		160	40.8	2.1	2.4			1.9	568	7.17	908		< 1	4	0.04					7				
18-Apr-02		96.6	23.2	< 1.0	1.1			2.3	337	7.11	609		< 1	< 0.01						6				
24-Oct-02		177	45					1.5	627	7.86	949		< 1	0.04						2.3				
22-May-03		121	26.4					10.4	411	7.48	708		< 1	< 0.01						3.9				
30-Oct-03		138	28.9					1.7	464	7.73	777		< 1	0.03	0.58	0.55	< 0.1	0.1	16					
20-May-04								1.5	394	7.22	606		< 1	0.05						3.8	0.173		< 0.001	< 0.01
30-Sep-04		140	31.6					1.7	481	7.29	760		< 1	0.03						3.4		0.001	< 0.01	
14-May-05		8.4	24.1					3.1	391	7.17	7.9	641	590	< 1	< 0.01					2.7		< 0.001	< 0.01	
29-Sep-05		12.5	136	29.3				1.7	460	7.23	7.6	803	704	< 1	0.03	0.84	0.81			9.2		0.0030	< 0.01	
29-Sep-05	*	9.7	137	29.6				1.6	464	7.16	806		< 1	0.03	0.52	0.49				9.1		0.0030	< 0.01	
4-May-06		9.7	109	23.2				0.5	368	7.52	7.4	604	604	< 1	0.03	0.69	0.66	< 0.1	0.1		0.88	0.0030		
28-Sep-06		12.1	128	28.5				1.2	437	7.2	7.8	730	737	< 1	0.02	0.6	0.58	< 0.1	0.1		0.32	0.0006		
10-May-07		8.0	106	22.6				0.7	388	7.64	7.5	595	618	< 1	< 0.01	1	0.99	< 0.1	0.1		0.46	0.0004		
4-Oct-07		13.6	132	26.5				1.6	451	7.33	7.7	822	715	< 1	< 0.01	0.32	0.31	< 0.1	0.2		0.16	0.0008		
15-May-08		9.7	104	20.6				1	345	7.5	7.5	564	581	< 1	0.02	0.39	0.37	< 0.1	< 0.1		0.15	0.0004		
2-Oct-08		12.1	123	25.6				1.1	413	7.86	7.2	739	625	< 1	0.05	0.47	0.42	< 0.1	0.1		0.07	0.0001		
21-May-09		10.1	113	24.1				1	380	6.41	651	580	< 1	< 0.01	0.45	0.44	< 0.1	0.1		0.07	0.0004			
15-Oct-09		11.1	129	26.6				1.3	431	6.59	7.7	749	737	< 1	< 0.01	0.51	0.50	< 0.1	0.1		0.22	0.0006		
6-May-10		8.8	117	25.3				1.1	386	6.99	7.4	694	586	< 1	< 0.01	0.51	0.50	< 0.1	0.2		0.25	0.0004		
11-Nov-10		10.7	130	26.7				2.8	434	6.67	7.6	736	817	< 1	0.03	0.41	0.38	< 0.1	< 0.1		0.1	0.0005		
5-May-11		7.9	88.6	18.2				2	0.8	296	7.32	8.0	578	474	< 1	0.01	0.30	0.29	< 0.1	< 0.1		0.05	0.0004	
29-Sep-11		13.9	117	24.9				1.0	394	7.50	7.2	740	670	< 1	0.02	0.32	0.30	< 0.1	< 0.1		0.09	< 0.0001		
29-Sep-11	*	115	24.5					1.0	387	7.51	727		< 1	0.03	0.33	0.30	< 0.1	< 0.1		0.08	0.0004			
19-Apr-12		9.2	97.8	19.2				1.1	323	7.72	7.3	543	546	< 1	< 0.01	0.31	0.31	< 0.1	< 0.1		0.05	0.0003		
4-Oct-12		13.7	129	27.9				1.6	438	7.78	7.42	731	746	< 1	< 0.01	0.49	0.49	< 0.1	0.1		0.08	0.0004		
2-May-13	*	7.8	96.3	18.0				1.0	315	7.79	7.25	468	415	< 1	< 0.01	0.44	0.44	< 0.1	< 0.1		0.06	0.0002		
2-May-13	*	98.1	18.1					0.5	320	7.84	472		< 1	0.01	0.41	0.40	< 0.1	< 0.1		0.05	0.0002			
3-Oct-13		13.2	130	25.2				0.7	430	7.61	7.02	667	644	< 1	0.02	0.57	0.55	< 0.1	< 0.1		0.04	0.0006		
7-May-14		7.2	85.2	18.7				0.8	281	8.03	7.38	492	492	< 1	< 0.01	0.40	0.40	< 0.1	< 0.1		0.02	0.0005		
2-Oct-14		13.4	139	25.2				0.5	452	7.70	7.19	715	698	< 1	0.04	0.56	0.52	< 0.1	< 0.1		0.05	0.0008		
6-May-15		7.7	105	20.2				0.5	345	7.83	7.55	536	515	< 1	< 0.01	0.7	0.7	< 0.1	< 0.1		0.04	0.0005		
22-Sep-15		14.7	137	27.2				0.5	454	7.70	7.82	747	765	< 1	0.04	0.4	0.36	< 0.1	< 0.1		0.03	0.0007		
4-May-16		7.9	102	20.9				0.8	341	7.98	7.38	520	548	< 1	0.05	0.4	0.35	< 0.1	0.1		< 0.01	< 0.0001		
28-Sep-16		15.1	121	25.3				29	0.5	406	7.92	7.39	696	647	< 1	0.03	0.48	0.45	< 0.1	< 0.1		< 0.01	0.0005	
28-Sep-16	*	122	25.4					29	0.5	408	7.87	7.08		1.85	< 1	0.05								

Monitoring Well OW5-19

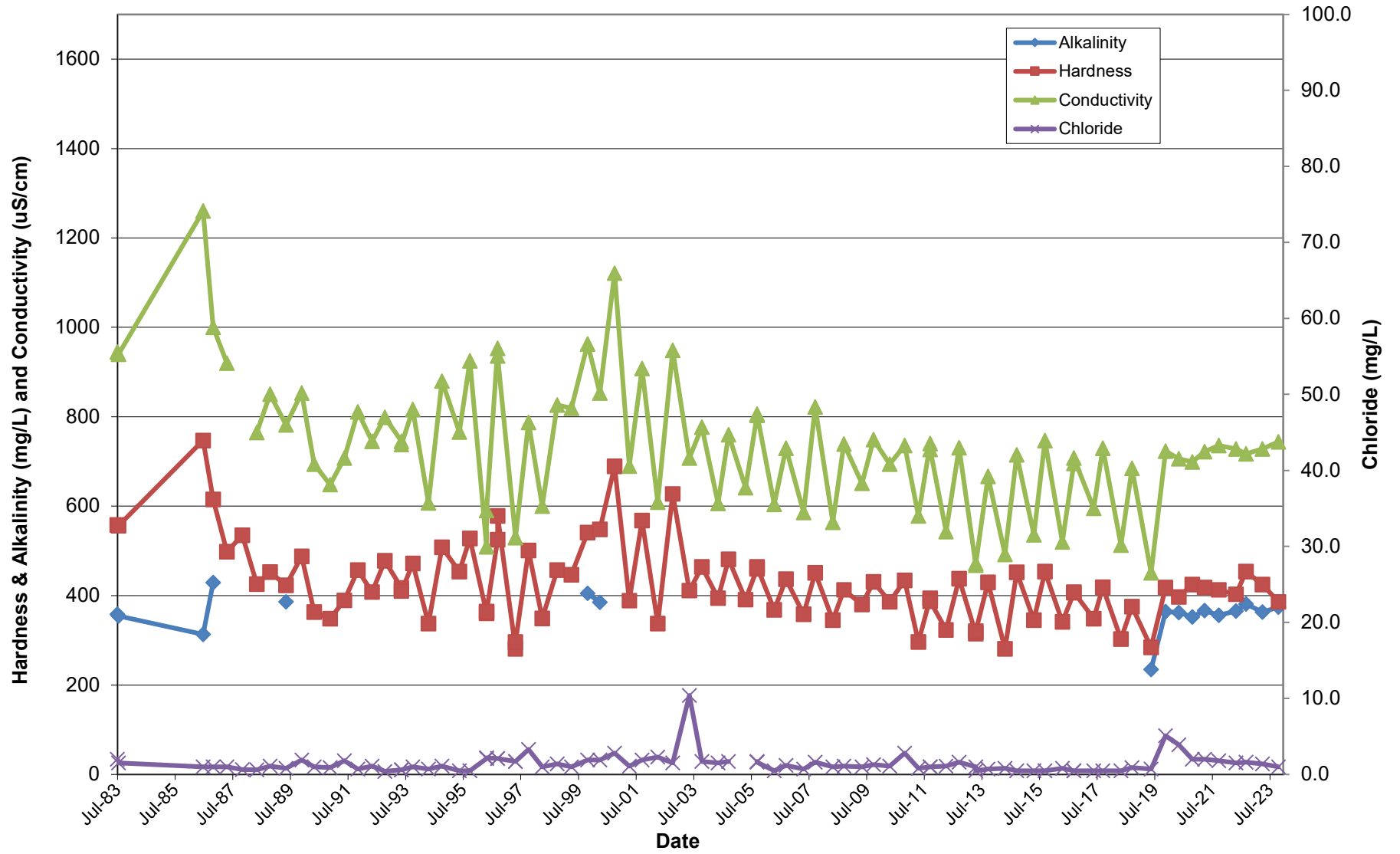

HISTORIC GROUNDWATER QUALITY DATA
Observation Well TH2-02

DATE	Temp (field) °C	Calcium	Magnesium	Sodium	Potassium	Alkalinity as CaCO3 30 - 500	Sulphate 500	Chloride 250	Hardness as CaCO3 80 - 100	pH 6.5 - 8.5	pH (field) 6.5 - 8.5	Conductivity (field)	Conductivity (field)	Iron 0.3	Phenols	Ammonia NH3 as N	TKN as N	Organic Nitrogen 0.15	Nitrite as N 1***	Nitrate as N 10***	DOC 5	Maganese 0.05	Total Phosphorus	Arsenic 0.025***	o-PO4
ODWQS				200																					
24-Oct-02	DRY													0.3				0.15	1***	10***	5	0.05		0.025***	
22-May-03		157	53.7					23.4	613	7.48		1050			< 1	0.02					3.3				
30-Oct-03		174	58.6					10.2	676	7.56		1140			< 1	0.13	1		<0.1	0.1		16			
20-May-04								11.1	652	7.07		943			< 1	0.25					2.4	0.781		0.001	<0.01
30-Sep-04		130	51.9					8.9	538	7.26		883			< 1	0.23								0.001	<0.01
30-Sep-04 *		129	52.3					8.9	537	7.28		882			< 1	0.24								0.001	<0.01
5-May-05	8	150	53						592	6.87	7.2	1020	930		< 1	0.27			<0.1	<0.1	2.1				<0.01
29-Sep-05	DRY																								
4-May-06	8.3	172	64					26	694	7.29	7.2	1150	1164		< 1	0.27	1.4	1.13	<0.1	<0.1			0.35	0.001	
4-May-06 *		174	64.5					26	700	7.29		1150			< 1	0.16	0.82	0.66	<0.1	<0.1			0.37	0.001	
28-Sep-06	DRY																								
10-May-07	7.5	170	57.4					43.6	662	7.26	7.4	1190	1200		< 1	0.22	0.55	0.33	<0.1	<0.1			0.69	0.0011	
4-Oct-07	DRY																								
15-May-08	7.3	190	66.7					39	751	7.54	7.2	1280	1323		< 1	0.09	0.57	0.48	<0.1	<0.1			0.29	0.0007	
2-Oct-08	10.7	138	45.1					31.5	531	7.75	7.1	1050	885		< 1	0.17	0.54	0.37	<0.1	0.1			0.16	0.0003	
2-Oct-08 *		138	45					31.6	530	7.76		1040			< 1	0.1	0.44	0.34	<0.1	0.1			0.16	0.0003	
21-May-09	7.9	211	75.4					42.4	839	6.61	7.5	1520	1309		< 1	0.23	0.5	0.27	<0.1	<0.1			0.15	0.0008	
15-Oct-09	10.7	132	49.3					32.9	533	6.48	7.8	1100	1045		< 1	0.1	0.64	0.54	<0.1	0.1			0.76	0.0008	
6-May-10	7.3	190	64.2					36.4	740	6.95	7.0	1340	1156		< 1	0.18	0.65	0.47	<0.1	<0.1			0.25	0.0006	
6-May-10 *		188	63.6					36.2	732	7.77		1340			< 1	0.17	0.64	0.47	<0.1	<0.1			0.54	0.0005	
11-Nov-10	9.5	137	54.4	20.2				3	566	6.59	7.0	1020	1103		< 1	0.23	0.43	0.2	<0.1	<0.1			0.15	0.001	
5-May-11	7.4	165	62.7	19.7			128	33.3	670	7.05	7.8	1340	1038		< 1	0.22	0.61	0.39	0.1	<0.1			0.52	0.0011	
29-Sep-11		127	53.4	21.6				23.8	537	7.30		1050			< 1	0.15	0.58	0.43	<0.1	<0.1			0.19	<0.0001	
19-Apr-12	7.9	171	72.2	22.4				29.4	770	7.30	7.1	1320	1324		< 1	0.09	0.46	0.37	<0.1	<0.1			0.13	0.0004	
4-Oct-12	12.5	132	55.9	21.2				22.4	561	7.72	7.02	963	1035		< 1	0.05	0.48	0.43	<0.1	0.1			0.29	0.0003	
2-May-13	7.9	227	78.0	26.5				36.1	889	7.49	7.15	1340	1248		< 1	0.12	0.76	0.64	<0.1	<0.1			0.63	0.0005	
3-Oct-13	12.0	130	49.9	22.2				23.0	530	7.55	7.06	895	826		< 1	0.12	1.00	0.88	<0.1	0.1			1.34	0.0004	
3-Oct-13 *		130	50.1	22.1				23.0	530	7.56		916			< 1	0.12	0.91	0.79	<0.1	0.1			1.55	0.0004	
7-May-14	6.9	195	72.7	23.6				39.1	786	7.68	6.93	1460	1411		< 1	0.13	0.57	0.44	<0.1	0.1			0.41	0.0008	
2-Oct-14	12.2	130	50.4	23.3				24.1	531	7.75	7.27	924	878		< 1	0.13	0.70	0.57	<0.1	<0.1			0.80	0.0006	
6-May-15	8.0	210	78.0	26.5				35.7	846	7.67	7.16	1320	1154		< 1	0.13	1.4	1.27	<0.1	0.1			2.90	0.0009	
6-May-15 *		212	79.4	24.1				27.7	857	7.69		1290			< 1	0.14	1.6	1.46	<0.1	0.1			3.14	0.0009	
22-Sep-15	12.3	118	49.8	24.1				22.1	501	7.79	7.91	908	890		< 1	0.11	0.4	0.29	<0.1	<0.1			0.19	0.0004	
4-May-16	7.6	217	85.1	29.8				37.6	892	7.72	6.85	1460	1474	0.301	< 1	0.19	0.5	0.31	<0.1	0.1			<0.01	0.0006	
4-May-16 *		199	88.3					231	37.6	862	7.76	1480		0.263	< 1	0.20	0.5	0.30	<0.1	0.1			<0.01	0.0004	
28-Sep-16								195	32.8	7.67		1290			< 1	0.04			<0.1	0.2					
5-Jun-17	8.8	202	76.9	25.1				233	23.5	822	7.43	6.90	1450	1360	<0.005	< 1	<0.01	0.5	0.50	<0.05	<0.05			<0.01	0.0003
27-Sep-17	11.6	155	62.9	23.5				154	20.4	846	7.85	7.33	1160	943	0.012	< 1	0.06	0.3	0.24	<0.05	<0.05			0.01	0.0003
27-Sep-17 *		157	63.4	23.6				154	20.4	853	7.87	1170		0.012	< 1	0.06	0.5	0.44	<0.05	<0.05			0.01	0.0002	
15-May-18	8.0	221	91.9	28.9				237	45.8	930	7.66	7.22	1530	1429	0.309	< 1	0.13	0.6	0.47	<0.05	<0.05			0.41	0.0003
3-Oct-18		191	77.0	24.3				203	32.1	794	7.83	1350		0.309	< 13	0.06	0.4	0.34	<0.05	<0.05			0.30	0.0005	
30-May-19		202	78.8			560	209	44.1	829	7.33		1410		0.054	< 0.002	0.1	0.7	0.60	< 0.05	0.13			0.77	0.0002	

OW6-19

25-Nov-19		123	54.8	7.5	3.5	391	95	30.3	533	7.64		966		0.288	< 0.002	0.2	1.3	1.1	< 0.05	0.26			3.84	0.0032
20-May-20		165	72.3	33.8	3.5	530	123	39.3	710	7.47		1230		< 0.005	< 0.002	0.2	17.9	17.7	< 0.5	< 0.5			24.7	0.0026
6-Nov-20		103	51.2	21.1	1.8	360	45	25.4	468	7.76		809		1.28	< 0.002	0.34			< 0.05	0.23			3.27	0.0133
8-Apr-21		160	73.8	24.9		531	152	32.2	704	7.61		1270			< 0.002	0.14	9.5	9.36	0.09	0.11			22.5	0.0017
7-Oct-21		145	62.3	28.6	2.6	462	113	29.9	619	7.5		1130		0.614	< 0.002	0.11	0.7	0.59	< 0.05	0.21			0.93	0.0005
11-May-22		265	99.9	7.2		553	409	3.5	1070	7.37		1640			< 0.001	< 0.01	0.3		< 0.05	< 0.05			0.15	0.0003
15-Sep-22		116	59	25.6	2.2	455	80	23.7	533	7.67		962		1.84	< 0.001	0.23	2.4		< 0.05	< 0.05			1.2	0.0172
11-Apr-23		166	70.4	49.9	2.6	564	136	34.9	704	7.53		1330		1.63	< 0.001	0.12	0.4		< 0.05	0.15			0.42	0.0019
2-Nov-23		88.1	47.6	23.3	1.7	394	58	27.4	416	7.87		851		<0.005	< 0.001	0.31	0.6		<0.05	0.29			0.36	0.0041
Average	9.1	168	63	24			194	28	680	7.44	7.23	1181	1142	0.201	1	0.15	0.68	0.53		0.11	5		0.62	0.001
Maximum	12.5	227	91.9	29.8			237	45.8	930	7.87	7.91	1530	1474	0.309	13	0.27	1.6	1.46		0.2	16		3.14	0.0011
Minimum	6.9	118	45	19.7			128	3	501	6.48	6.85	882	826	0.012	1	0.02	0.3	0.2		0.1	2.1		0.01	0.0002
Count																								

Monitoring Well OW6-19

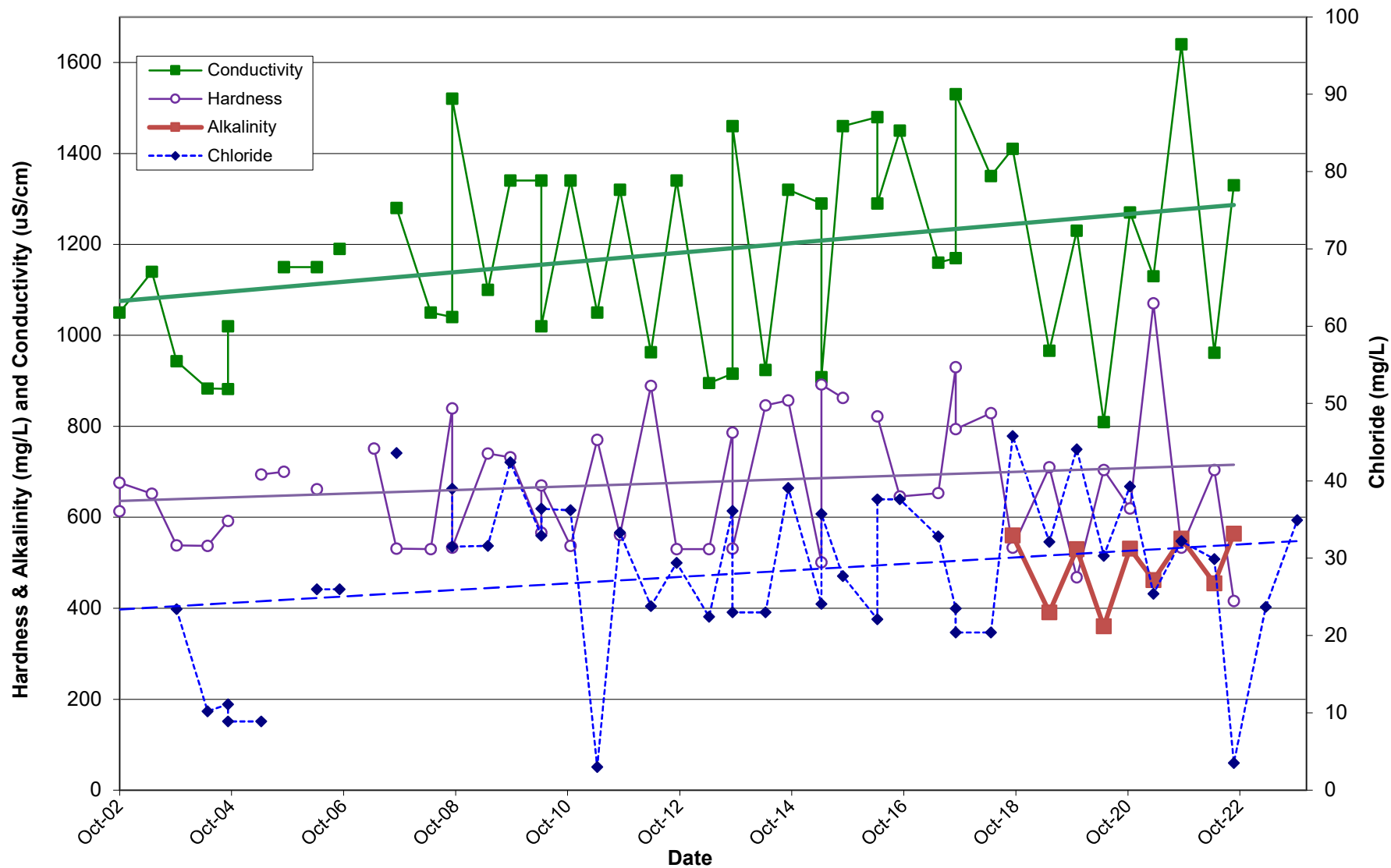

HISTORIC GROUNDWATER QUALITY DATA
Monitoring Well TH2-81

DATE	Temp (field) °C	Calcium	Magnesium	Sodium	Potassium	Alkalinity as CaCO3	Sulphate	Chloride	Hardness as CaCO3	pH	pH (field)	Conduct.	Conduct. (field)	Iron	Phenols	Ammonia NH ₃ as N	TKN as N	Nitrite as N	Nitrate as N	DOC	Maganese	
ODWQS				200		30 - 500	500	250	80 - 100	6.5 - 8.5	6.5 - 8.5			0.3				1***	10***	5	0.05	
19-Nov-87		135.4	57.2					14.8	574	7.49					< 1						5.8	
19-May-88		122.2	56.5					17.2	538	7.84		1005			< 1						6.7	
2-Nov-88		148.4	61.5					30	625	7.16		1195			< 1						6	
24-May-89		150	66	14.2	4.8	524	140	14	647	6.96		1172		3.6	< 1	0.476	0.05			0.5	0.92	
11-Dec-89		168	65					12.8	688	7.47		1203			< 1						4.0	
16-May-90		162	68					13.4	685	7.22		1211			2.5							
4-Dec-90		183	74					9.9	762	7.12		1295			< 1						4.1	
3-Jun-91		178	74					10.5	750	7.16		1256			< 1						3.8	
19-Nov-91		144	62					8.2	615	7.25		1114			3.0						4.7	
19-May-92		153	67.5					7.9	661	7.08		1182			< 1						3.9	
26-Oct-92		159	70.0					9.2	687	7.15		1159			< 1	0.025					3.5	
25-May-93		163	68.1					9.7	689	7.17		1182			2.0	0.159					2.2	
18-Oct-93		150	64.4					8.6	640	7.18		1136			< 1	0.176					3.5	
3-May-94		163	69.9	11.8	5.2			12.2	695	7.18		1239			< 1	0.212					3.9	
29-May-95		170	79.7					12	754	7.02		1262			11.3	0.18					3.8	
11-Oct-95		DRY																				
9-May-96		191	73.3					10.6	778	6.89		1275			< 1	0.02				<	1	
25-Sep-96		DRY																				
8-May-97		160	68.0					9.7	679	7.01		1218			< 1	0.10					4	
23-Oct-97		DRY																				
16-Apr-98		172	67.5					9.5	707	7.15		1209			< 1	0.08					14	
21-Oct-98		DRY																				
21-Apr-99		131	49					12.8	529	7.36		1182			< 1	0.03		1.1	<0.1		14	
11-Nov-99		DRY																				
13-Apr-00		201	91.6			554	332	16.2	879	7.06		1603		0.58	< 1	0.06					5	0.456
17-Oct-00		DRY																				
24-Apr-01		DRY																				
3-Oct-01		DRY																				
18-Apr-02		249	107	14.3	6.5			16.8	1062	6.84		1698			< 1	0.03					10	
Average		164	69.5	13.4	5.5	539	236	12.7	697	7.18		1240		2.09	1.7	0.129	0.05				5.22	0.688
Maximum		249	107	14.3	6.5	554	332	30	1062	7.84		1698		3.6	11.3	0.476	0.05				14	0.92
Minimum		122.2	49	11.8	4.8	524	140	7.9	529	6.84		1005		0.58	1	0.02	0.05				0.5	0.456
Count		29	21	3	3	2	2	21	21	21		20		2	21	12	1				20	2

All results expressed as mg/L except the following parameters

pH as -log [H⁺]

phenols as ppb

conductivity as µS/cm

* Monitoring well TH2-81 was decommissioned in 2002 and replaced in the monitoring program by TH2-02

*** Standard related to health.

HISTORIC GROUNDWATER QUALITY DATA
Monitoring Well TH4-02

DATE	Temp (field) °C	Ca	Mg	Na	K	Alk. as CaCO3	SO4	Cl	Hardness as CaCO3	pH	pH (field)	Conduct	Conduct (field)	Fe	Phenols	Free NH3 as N	TKN as N	Organic Nitrogen	NO2 as N	NO3 as N	DOC	Mn	Total P	As	o-PO4
ODWQS				200		30 - 500	500	250	80 - 100	6.5 - 8.5	6.5 - 8.5			0.3				0.15	1***	10***	5	0.05		0.025***	
24-Oct-02		99.1	52.4					8.8	463	7.86		807			<	1	0.08								
22-May-03		114	65.7					27.6	555	7.65		1020			<	1	0.10					1.7			
30-Oct-03		113	65.2					43.8	550	7.85		1040			<	1	0.13	3.59		<0.1	<0.1	11			
20-May-04								44.4	566	7.33		922			<	1	0.15					2.1	0.63		0.006 <0.01
30-Sep-04		107	62.3					39.2	524	7.3		932			<	1	0.13					2			0.005 <0.01
5-May-05		117	68.3						574	7.1		1160			<	1	0.11					1.2			0.004 <0.01
5-May-05 *	8.3	119	69.1						581	7.1	7.9	1160	1100		<	1	0.11					1.3			0.005 <0.01
29-Sep-05	11.6	119	59.9					178	543	7.31	7.5	1400	1269		<	1	0.13	0.97	0.84			6.2			0.003 <0.01
4-May-06	9.3	121	68.7					117	586	7.53	7.5	1190	1193		<	1	0.07	1.55	1.48	<0.1	<0.1		1.28		0.006
28-Sep-06	11.7	107	56.7					100	502	7.19	7.8	1100	1100		<	1	0.11	0.87	0.76	<0.1	0.1		0.91		0.0066
10-May-07	8.4	111	62.9	46.1	1	498	35	85.6	536	7.61	7.3	1060	1117	1.28	<	1	0.11	0.76	0.65	<0.1	<0.1		0.81		0.0066
4-Oct-07	14.3	102	53.5					80.8	475	7.32	8.1	1010	962		<	1	0.02	0.59	0.57	<0.1	<0.1			0.75	0.006
15-May-08	8.8	109	59.6					75.6	518	7.42	7.5	1050	1020		<	1	0.06	1.91	1.85	<0.1	<0.1		2.75		0.0044
15-May-08 *		110	59.8					75.6	521	7.39		1040			<	1	0.07	1.91	1.84	<0.1	<0.1		2.78		0.0043
2-Oct-08	10.7	101	51.1					57.7	461	7.87	7.1	990	840		<	1	0.12	0.67	0.55	<0.1	<0.1		0.82		0.0048
21-May-09	9.9	104	58.5					55.7	501	6.8	7.7	1010	930		<	1	0.09	1.95	1.86	<0.1	<0.1		3.17		0.0056
21-May-09 *		105	58.1					56	501	7.18		1010			<	1	0.09	1.97	1.88	<0.1	<0.1		3.32		0.0052
15-Oct-09	12.1	92.5	51.4					43.9	443	6.49	7.9	933	893		<	1	0.07	2.74	2.67	<0.1	<0.1		6.76		0.0037
6-May-10	7.7	96.3	53.4					47.8	460	7.2	7.1	1003	850		<	1	0.11	2.5	2.39	<0.1	<0.1		3.65		0.005
11-Nov-10	11.4	107	59.5					58.7	512	6.7	7.1	978	1102		<	1	0.13	1.39	1.26	<0.1	<0.1		2.54		0.0094
5-May-11	7.6	97.9	56.7				16	52.6	478	7.47	7.5	1060	810		<	1	0.10	6.58	6.48	<0.1	<0.1		13.3		0.0074
29-Sep-11	13.5	96.2	56.0					53.1	471	7.60	7.1	1010	941		<	1	0.15	2.36	2.21	<0.1	0.1		4.96		0.0067
19-Apr-12	9.2	106	62.2					47.9	521	7.64	7.3	974	966		<	1	0.05	2.39	2.34	<0.1	0.1		3.64		0.0049
3-Oct-12	13.2	103	54.4					70.1	482	7.92	7.46	902	960		<	1	0.11	1.64	1.53	<0.1	<0.1		2.85		0.0051
3-Oct-12 *		103	54.5					70.3	483	7.94		913			<	1	0.11	1.64	1.53	<0.1	<0.1		3.19		0.0050
2-May-13	8.9	112	58.0					66.3	519	7.83	7.12	918	837		<	1	0.10	1.05	0.95	<0.1	<0.1		1.31		0.0050
3-Oct-13	12.8	168	84.0					316	765	7.59	7.03	1580	1422		<	1	0.18	0.75	0.57	<0.1	0.1		0.71		0.0079
7-May-14	7.3	117	63.0					157	552	7.91	7.28	1190	1192		<	1	0.10	0.56	0.46	<0.1	<0.1		0.37		0.0064
2-Oct-14	12.9	120	61.1					130	551	7.81	7.34	1090	1051		<	1	0.14	1.02	0.88	<0.1	<0.1		1.74		0.0086
2-Oct-14 *		121	61.8					130	555	7.82		1100			<	1	0.14	0.95	0.81	<0.1	<0.1		1.83		0.0073
6-May-15	7.8	109	59.6					93.0	518	7.87	7.45	1010	933		<	1	0.10	0.6	0.5	<0.1	0.1		0.51		0.0050
22-Sep-15	16.2	111	56.9					73.6	512	7.77	8.18	987	1027		<	1	0.13	1.0	0.87	<0.1	<0.1		1.96		0.0030
22-Sep-15 *		116	59.4					74.8	534	7.86		998			<	1	0.13	1.2	1.07	<0.1	<0.1		2.51		0.0028
4-May-16	9.4	111	60.6				20	59.0	525	7.93	7.34	969	1010	2.44	<	1	0.17	0.4	0.23	<0.1	0.1		<0.01		0.0062
28-Sep-16	14.6	103	53.3				19	58.8	477	7.89	7.36	941	864	0.049	<	1	0.13	0.46	0.33	<0.1	<0.1		<0.01		0.0034
5-Jun-17	9.7	102	54.2				16	38.6	478	7.75	7.28	918	864	<0.005	<	1	0.12	0.4	0.28	<0.05	<0.05		<0.01		0.0020
5-Jun-17 *		101	53.7				16	38.7	474	7.84		916		<0.005	9	0.16	0.4	0.24	<0.05	<0.05		0.04		0.0021	
27-Sep-17	13.4	103	56.4				14	55.3	489	7.94	7.02	970	780	1.01	<	1	0.15	0.6	0.45	<0.05	<0.05		0.01		0.0072
15-May-18	8.1	109	61.4				15	69.9	525	7.95	7.35	978	935	2.57	<	1	0.28	3.8	3.52	<0.05	<0.05		6.06		0.0056
3-Oct-18	12.5	107	54.0				15	153	489	7.95	7.25	1150	1000	0.991		12	0.30	2.3	2.0	<0.05	<0.05		4.45		0.0052
3-Oct-18 *		108	53.8				15	153	491	7.94		1170		1.04		13	0.29	2.2	1.91	0.06	<0.05		2.64		0.0052
30-May-19		109	54.1			354	26	121	495	7.66		1040		1.91	<	0.002	0.24	2.2	1.96	<0.05	0.19		4.69		0.0021
25-Nov-19		117	56.6			356	26	141	525	7.83		1110		0.471	<	0.002	0.12	0.7	0.58	<0.05	0.21		0.8		0.0017
20-May-20		109	57.5	37.7	1.6	370	22	93.1	509	7.74		1000		<0.005	<	0.002	0.37	5.2	4.83	<0.05	0.16		6.91		0.0008
6-Nov-20		115	55.4	43.4	1.2	354	21	102	515	7.84		984		2.75	<	0.002	0.17			<0.05	0.09		2.42		0.0066
8-Apr-21		104	55.4	42		384	20	94.3	488	7.83		1020			<	0.002	0.21	3.6	3.39	0.09	0.17		5.66		0.0022
7-Oct-21		104	51.2	42.3	1.3	362	18	77.4	470	7.82		941		2.53	<	0.002	0.1	1	0.90	0.07	0.18		0.58		0.0078
11-May-22		26.7	43	7.9		223	5	15.7	243	7.84		465			<	0.001	<0.01	0.4		<0.05	<0.05		0.07		<0.0001
15-Sep-22		97.5	46.2	36.2	1.9	384	11	61.3	434	7.75		872		2.21	<	0.001	0.2	7.5		<0.05	<0.05		1.73		0.0093
11-Apr-23		106	54.7	35	1.5	406	19	62.7	491	7.77		971		0.574	<	0.001	0.13	1.1		<0.05	0.2		0.13		0.0016
Average	10.8	109.5	59.3				18.1	81.0	519	7.57	7.424	1038	999	1.340		1.7561	0.13	1.6	1.40			3.64	0.6	2.72	0.0053
Maximum	16.2	168	84				35	316.0	765	7.95	8.180	1580	1422	2.57		13	0.3	6.6	6.48			11	0.6	13.30	0.0094
Minimum	7.3	92.5	51.1				14	8.8	443	6.49	7.020	807	780	0.049		1	0.02	0.4	0.23			1.2	0.6	0.01	0.0020
Count	28	40	40				10	39	41	41	28	41	28	7		41	41	35	34			7	1	30	38

All results expressed as mg/L except the following parameters
 pH as -log [H+]
 phenols as ppb
 conductivity as µS/cm
 * denotes duplicate sample
 *** Standard related to health.

Monitoring Well TH4-02

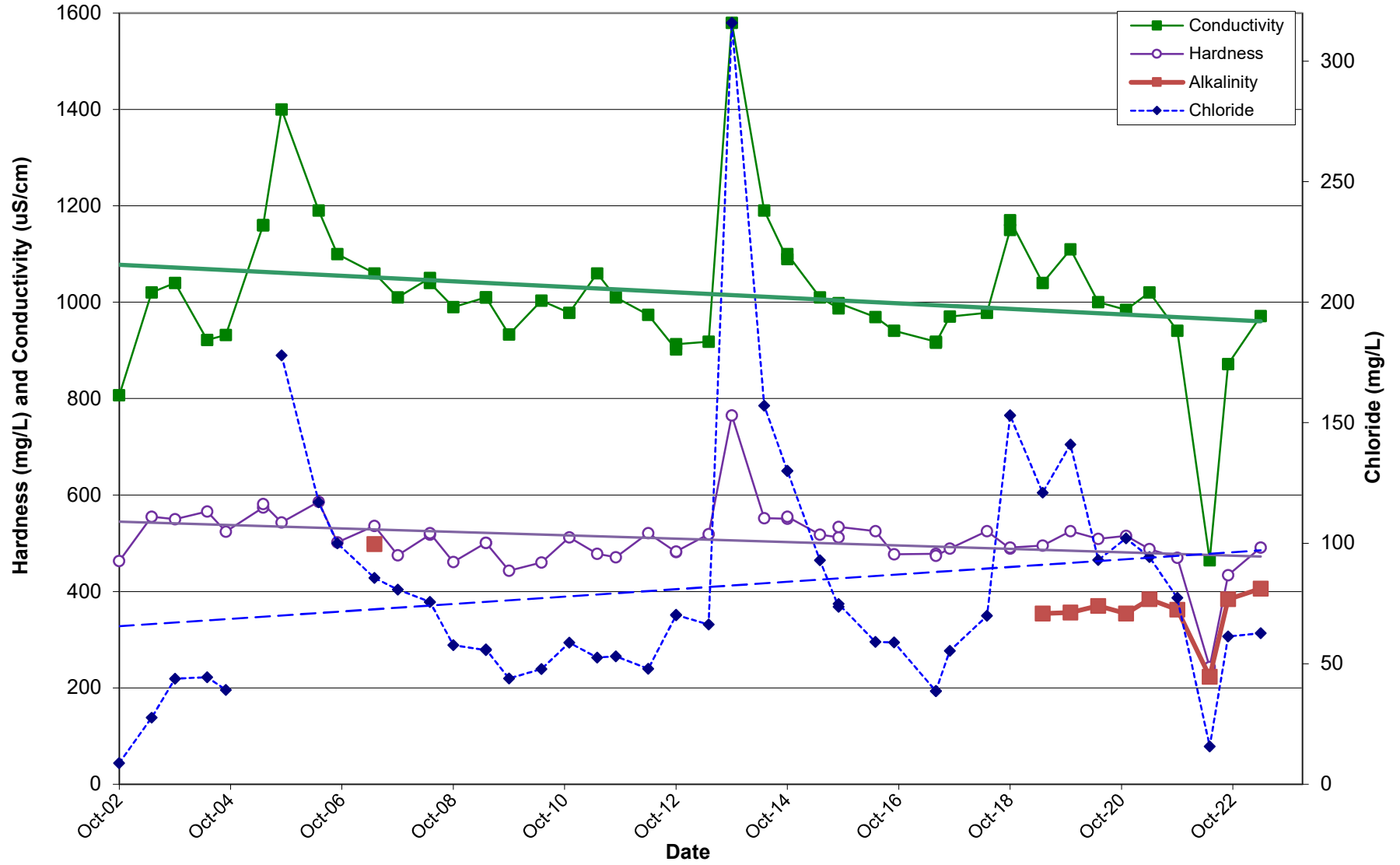

HISTORIC GROUNDWATER QUALITY DATA
Monitoring Well TH6-01

DATE	Temp (field) °C	Ca	Mg	Na	K	Alk as CaCO3	SO4	Cl	Hardness as CaCO3	pH	pH (field)	Conduct	Conduct (field)	Fe	Phenols	Free NH ₄ as N	TKN as N	Organic Nitrogen	NO ₂ as N	NO ₃ as N	DOC	Mn	Total P	As	o-PO ₄					
OBWGS				200		30-500	500	250	180-100	6.5-8.5	6.5-8.5			0.3				0.15	1***	10***	5	0.05		0.025***						
16-Oct-81		224	86	7.9	2.9	755	13	11	830	7.2		1310		0.35																
18-Jul-83															15.5															
18-Jul-83		136	48			550	5	3	536	8		730		0.32																
8-Jul-86		115	63	2	1.7	598	40	1.5	547	7.49		1210		3.22	< 1	2.47	3.25		0.03	0.3		4.7	1.6							
23-Nov-86		138	57	9	2.45	516	37	3.5	580	7.67		1000		6.8	< 1	1.3	2.26					3.8	0.83							
5-May-87		155	65					2	835	7.3		1150							0.01											
19-Nov-87		142	51.29						2.13	566	7.54																			
19-May-88		124.8	57.52						2.83	549	7.49		1060																	
2-Nov-88		143.8	49.58						8.63	563	7.03		1033																	
24-May-89		167	70	3.71	0.9	543	59	0.7	705	6.84				8.6	< 1	0.205									3.5	0.96				
11-Dec-89		238	80						1.4	925	6.98		1530																	
16-May-90		225	84						0.8	909	6.8		1520																	
14-Dec-90		212	75						1.2	839	6.99		1390																	
3-Jun-91		227	88	4.0	1.8	756	221	1.6	930	6.9		1570																		
19-Nov-91		240	94	5	2.2	620		0.9	967	6.92		1540		0.59																
19-May-92		274	82.3					< 0.1	1375	6.76		1500																		
26-Oct-92		195	90.5	5.8	1.9	531	192	1.1	864	7.14		1480		2.13	2.00	0.376	0.32		< 0.01	< 0.1		2.8			0.019					
25-May-93		222	82.8	5.4	1.6	724	235	1.1	897	6.87		1480		3.66	< 1	0.106	1.34		< 0.01	< 0.1		2.5			0.011					
18-Oct-93		163	69.5	7.3	1.7	499	170	1.8	694	6.97		1259		0.91	< 1	0.085	0.27		< 0.01	< 0.1		2.6			0.007					
18-Oct-93 *		161	71.6	7.4	1.7	492	156	2.3	698	6.93		1289		0.95	< 1	0.085	0.27		< 0.01	< 0.1		2.6			0.006					
3-May-94		198	77.2	6.2	1.3	513	172	13.9	813	7.36		1390		2.97	< 1	0.200	0.28		< 0.01	0.2		2.8			1.49	0.011				
29-May-95		256	96.1	6.7	1.92	637	244	0.8	1038	6.92		1610		2.41	2.8	0.08	0.45		< 0.01	< 0.1		3.5			1.68	0.06				
11-Oct-95		234	101	6.6	1.84	631	225	0.9	1001	6.92		1650		4.43	< 1	0.27	0.58		< 0.01	0.3		< 1			1.58	0.02				
8-May-96		239	91.6	7	1.5	748	193	2.3	876	7.5		1511		3.37	< 1											1.48				
25-Sep-96		193	94.7	6.3	2	724	216	2.5	872	7.05		1610		< 0.01	< 1	0.28										3	0.993			
8-May-97		207	79	4.7	1	688	177	2.5	827	8.14		1429		4.73	< 1	0.11	0.37									1	1.04			
23-Oct-97		238	90.8	7.6	2.5	698	263	3.4	963	6.9		1633		1.09	< 1	0.17											1	1.04		
16-Apr-98		219	87.3	8.0	1.8	645	209	2.2	906	6.82		1565		1.58	< 1	0.08											1	1.47		
16-Apr-98 *		249	95.0	8.1	1.9	774	216	2.2	1013	6.79		1562		1.55	< 1	0.08											1	1.45		
21-Oct-98	DRY																													
21-Apr-99		374	122	7.9	4.3	599	903	2.1	1436	6.95		2330		1	< 1	0.04											1	2.02		
11-Nov-99		394	122	9	3.5	493	979	1.6	1486	6.77		2190		0.05	< 1	< 0.01												1	0.213	
13-Apr-00		290	105	8.9	2.3	572	690	2.2	1157	6.79		1967		0.94	< 1	0.02											3	1.53	< 0.01	
17-Oct-00		354	111	9.62	3.35	703	571	3.2	1341	7.03		2050		2.64	< 1	0.04												19	2.09	
24-Apr-01		311	124	7.8	2.4	675	635	2	1287	6.77		2140		1.83	< 1	0.08												8	2.02	
3-Oct-01		311	106	8.6	3.7	582	695	2.5	1213	6.85		1969		0.03	< 1	< 0.01												8	0.21	
18-Apr-02		247	88	9.5	2.5	583	325	3.1	979	6.91		1532		0.47	< 1	0.01												8	1.15	
18-Apr-02 *		242	86.9	8.6	2.4			3.1	962	6.84		1537			< 1	0.02												3		
24-Oct-02	DRY																													
22-May-03		302	97.1	8.4	1.5	477	742	2.1	1154	7.42		1760		0.07	< 1	< 0.01											2.3	0.54	< 0.01	
22-May-03 *		300	96.0	8.3	2.0	480	750	2.6	1145	7.38		1740		0.08	< 1	< 0.01											1.6	0.54	< 0.01	
30-Oct-03		287	89.2	8.8	2.7	561	551	6.2	1080	7.49		1660		0.05	< 1	0.04	0.34	0.3	< 0.1	< 0.1							10	0.40	0.06	
30-Oct-03 *		290	90.4	8.9	2.7	570	550	2.2	1100	7.43		1670		0.056	< 1	0.03	0.31	0.28	< 0.1	< 0.1							22	0.41	0.07	
20-May-04						8.6	2.5	591	490			1430		0.244	< 1	0.04											1.3	0.63	0.001	< 0.01
30-Sep-04		325	112	9.4	3.4	654	630	3	1270	6.97		1800		0.348	< 1	0.08											2.3	0.38	0.001	< 0.01
5-May-05		7.2	296	102	7.9	2	595	500	2.8	1160	6.67	7.1	1680	1641	0.658	< 1	0.04		< 0.1	< 0.1						1.2	0.877	0.001	< 0.01	
29-Sep-05	DRY																													
4-May-06		301	104	8.8	2.8	506	610	2.8	1180	7.19	7.2	1710	1638	0.044	< 1	< 0.01	0.95	0.94	< 0.1	< 0.1							0.41	0.002		
28-Sep-06	DRY																													
10-May-07		8.3	278	96.1	8.4	2.6	615	530	2.3	1090	7.22	7.0	1550	1683	0.193	< 1	0.04	2	1.96	< 0.1	< 0.1					1.75	0.0008			
10-May-07 *		278	95.6	8.6	2.7	612	550	1.7	1090	7.17		1670		0.207	< 1	0.12	1.28	1.16	< 0.1	< 0.1							1.83	0.0008		
4-Oct-07	DRY																													
15-May-08		9.2	281	99.3	9.8	3.2	570	460	1.7	1110	7	7.0	1690	1634	0.186	< 1	< 0.01	0.3	0.29	< 0.1	< 0.1						0.12	0.0008		
2-Oct-08		11.7	282	86.1	10.4	3.3	666	480	2.6	1060	7.35	6.8	1740	1482	1.02	< 1	0.05	0.31	0.26	< 0.1	< 0.1						0.07	0.0009		
21-May-09		9.7	276	97.2	8.1	2.3	600	380	2.6	1090	6.63		1620	1516	1.15	< 1	0.03	0.23	0.2											

Monitoring Well TH6-81

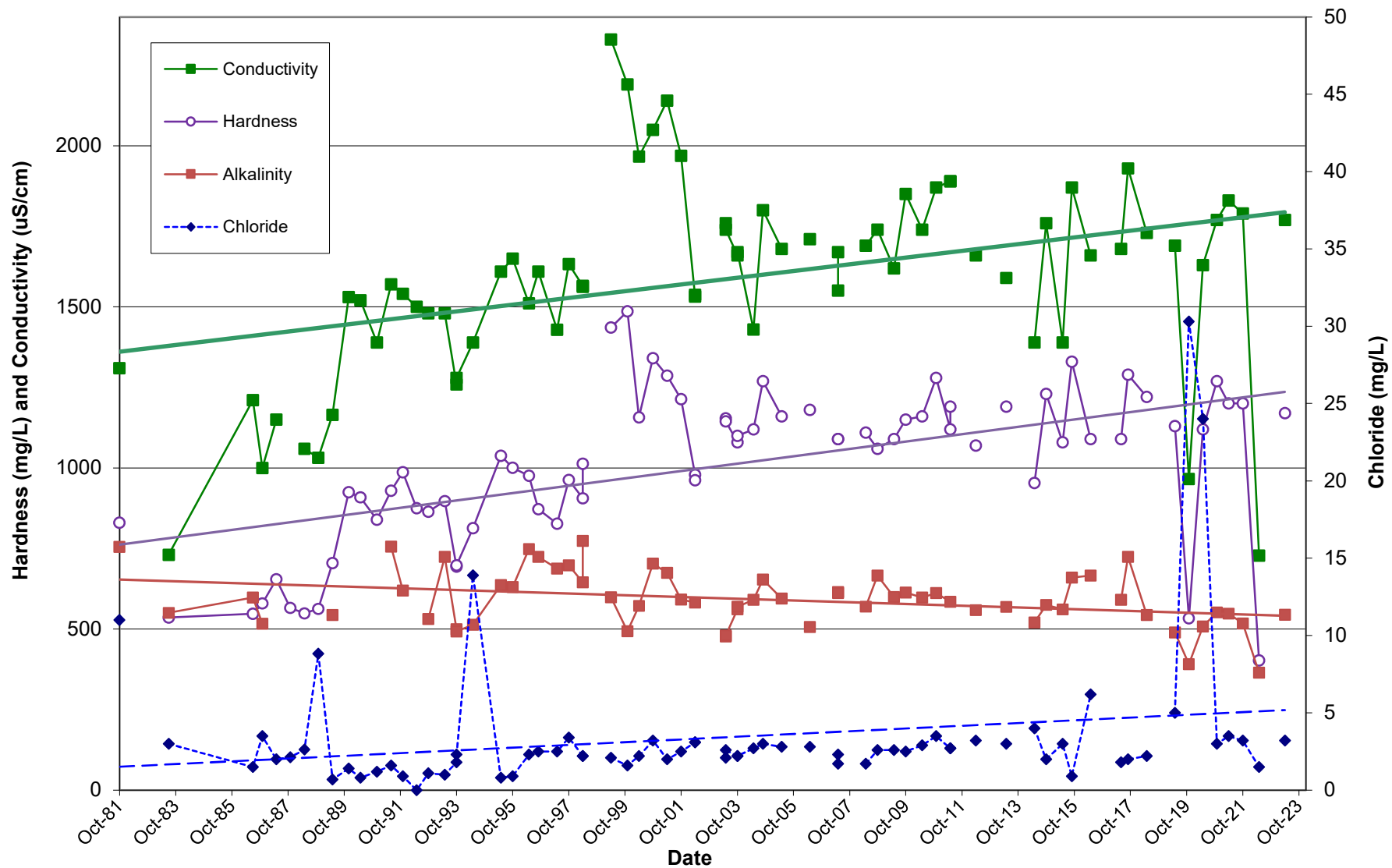

HISTORIC GROUNDWATER QUALITY DATA
Monitoring Well TH7-81

DATE	Temp (field) °C	Ca	Mg	Na	K	Alk. as CaCO3 30 - 500	SO4 500	Cl 250	Hardness as CaCO3 80 - 100	pH	pH (field)	Conduct.	Conduct. (field)	Fe	Phenols	Free NH ₃ as N	TKN as N	Organic Nitrogen 0.15	NO ₂ as N 1***	NO ₃ as N 10***	DOC 5	Mn 0.05	Total P	As 0.025***	o-PO ₄		
ODWQS				200					6.5 - 8.5	6.5 - 8.5			0.3														
16-Oct-81		60	22	17	2.0	232	39	12	241	7.7		510		0.02		-	-										
18-Jul-83		73.5	41.2	16.9	2.10	357	21.5	7.5	353	7.88		690		0.47	1.5	0.195											
2-Aug-83		68	38.4	15.2	2.1	343	30	6.0	328	7.87		660		0.94	1.0	0.095											
9-Jul-86		69.5	45	14	2.5	356	920	5	859	7.75		875		8.2	<	1	0.535	1.18		0.01	0.1	2.5	0.25				
13-Nov-86		104	52	12	1.75	426	90	4.5	474	7.62		860		2.42	<	1	0.3	0.68		<0.01	0.1	2.5	0.14				
5-May-87		112	62					5	535	7.39		970		<	1	0.245	0.94		0.01	0.5	7.1						
19-Nov-87		113.2	27.73					4.01	397	7.64				<	1						3						
19-May-88		90.8	55.4					4.68	455	7.84		915		<	1						4.6						
2-Nov-88		95.6	50.03					6.78	445	7.48		873		<	1						3						
24-May-89		123	65	14.4	1.9	465	155	3.5	575	7.28		1055		2.7	1.0	0.128						0.124					
11-Dec-89		67.7	35.3					1.7	315	7.82		584		<	1						20						
16-May-90		143	72					3.4	654	7.62		1146		<	1						0.8						
4-Dec-90	NOT SAMPLED														3.5												
3-Jun-91		96	51					2.4	450	7.7		841		4.02	<	1	0.118					0.9					
19-Nov-91		46.8	24.5					1.4	218	7.78		442										0.6					
19-May-92		80.4	45.5					4.4	388	7.52		695			2.5							1.0					
26-Oct-92		84.1	59.9					9.4	457	7.70		900			1.0							1.3					
25-May-93		117	56.2					10.0	525	7.59		933			**	0.078						1.3					
18-Oct-93		92.9	58.5					9.3	473	7.43		922		<	1	0.111						1.8					
3-May-94		133	62.4	18.2	1.6			18.0	591	7.39		1071			1	0.136						2.0					
21-Oct-94		111	62.4					13.9	537	7.28		955			2.1	0.056						2.2					
29-May-95		127	69.3					16.1	605	7.4		1095			3.5	0.13						2.4					
11-Oct-95		106	62					15	521	7.34		1012			2.3	0.25											
9-May-96		118	51.1					20.2	505	7.03		1036		<	1	0.11					<	1					
25-Sep-96		123	60.4					21.2	556	7.28		1043		<	1	0.17					<	1					
8-May-97		100	56.9					22.8	484	7.45		1060		<	1	0.13						3					
23-Oct-97		123	65.5					17.3	577	7.72		1042		<	1	0.19						<	1				
16-Apr-98		132	59.5					19.9	575	7.65		1073		<	1	0.11						<	1				
21-Oct-98		108	47.5					4.9	465	7.18		871		<	1	0.15						<	1				
21-Apr-99		134	57					27.6	569	7.5		1241		<	1	0.09						<	1				
11-Nov-99		133	65.5	24.8	2	369	245	25.5	602	7.36		1130		0.72	<	1	0.06					7		0.05			
13-Apr-00		167	71.3			374	361	35.3	711	7.43		1460		0.81	<	1	0.03					3		0.053			
17-Oct-00		181	82.7					31.0	792	6.93		1411		<	1	0.18							12				
24-Apr-01		183	88					29.6	819	7.26		1425		<	1	0.07							11				
3-Oct-01		124	60.9	28.6	2.6			22.5	560	7.36		1151		<	1	0.16							2				
18-Apr-02		166	81.1	28.8	2.2			23.4	753	7.11		1347		<	1	0.15							5				
24-Oct-02		97.7	50.1					11.2	450	7.93		801		<	1	0.16							0.7				
22-May-03		219	95.3					16.8	939	7.53		1540		<	1	0.14							<0.01				
30-Oct-03		217	93.1					25.2	925	7.72		1540		<	1	0.2	5.95	5.75	<0.1	<0.1					0.013	<0.01	
20-May-04								37.4	1020	7.17		1550		<	1	0.2							1.3		0.173		0.013
30-Sep-04		169	80.7					23.1	756	7.23		1220		<	1	0.19							1.3			0.005	<0.01
5-May-05	7.7	215	98.2					94.2	6.86	7.3	1510	1427		<	1	0.13							1.2			0.005	<0.01
29-Sep-05	10.2	114	53.7					14.7	506	7.39	8.9	990	894		<	1	0.14	0.99	0.85				5.2			0.005	<0.01
14-May-06		151	70					32.4	665	7.77		1280		<	1	0.08	1.11	1.03	<0.1	0.1						1.33	0.003
28-Sep-06		103	51					45.4	380	66.1	821	7.13	6.9	1550	1317	2.92	<	1	0.12	0.8	0.68	<0.1	<0.1			0.91	0.0017
10-May-07	10.4	198	91.7					44.6	871	7.5	7.8	1470	1506		<	1	0.12	0.53	0.41	<0.1	<0.1					0.39	0.0067
4-Oct-07		85.8	40.5					8	381	7.51		754		<	1	0.09	1.15	1.06	<0.1	<0.1						1.59	0.0046
15-May-08	8.7	183	87.4					56.6	817	7.32	7.4	1580	1559		<	1	0.1	2.1	2	<0.1	<0.1					4.01	0.0032
2-Oct-08		133	57.8					27.1	569	8.06		1110		<	1	0.13	0.78	0.65	<0.1	0.1						0.94	0.003
21-May-09	8.9	185	90.6					48.1	836	6.79	6.9	1530	1402		<	1	0.13	0.64	0.51	<0.1	<0.1					0.84	0.0045
15-Oct-09	9.3	90.1	45.8	15.8	1.6	295	145	12.3	414	6.79	8.2	776	762	0.264	<	1	0.07	0.45	0.38	<0.1	0.1					0.62	0.0003
15-Oct-09	*	85.4	43.5	15	1.5	294	146	12.3	392	7.1		783		0.271	<	1	0.07	0.5	0.43	<0.1	0.1					0.6	0.0003
18-May-10		7.1	190	84.4		454	380	66.1	821	7.13	6.9	1550	1317	2.92	<	1	0.12	0.43	0.31	<0.1	0.1					0.45	0.0042
11-Nov-10	10	174	92.9			465	337	62.9	816	7.21	7.2	1460	1614	1.1	<	1	0.15	0.42	0.27	<0.1	<0.1					0.42	0.0047
5-May-11	7.3	177	91.7			552	301	95.6	819	7.18	7.6	1730	1325	2.00	<	1	0.14	0.49	0.35	<0.1	<0.1					0.33	0.0068
29-Sep-11		107	54.6	20.7	1.8	316	160	22.9	492	7.73		938		0.337	<	1	0.12	1.17	1.05	<0.1	<0.1					1.65	0.0017
19-Apr-12	8.0	158	91.9			406	369	100	820	7.43	7.2	1540	1573	1.23	<	1	0.09	0.49	0.40	<0.1	0.1					0.12	0.0040
3-Oct-12	12.2	69.4	34.8	13.1	1.5	260	68	8.0	316	8.01	8.07	595	637	0.253	<	1	0.05	1.41	1.36	<0.1	0.1					2.88	0.0042
2-May-13	7.3	171	81.5			398	430	67.6	764	7.60	6.80	1730	1642	1.06	<	1	0.13	0.45	0.32	<0.1	<0.1					0.15	0.0031
3-Oct-13	10.7	92.8	46.0	23.4	1.7	284	137	29.4	421	7.77	7.42	768	707	0.139	<	1	0.10	0.36	0.26	<0.1	<0.1					0.27	0.0030
7-May-14	6.5	150	75.3			378	307	97.9	684	7.85	7.20	1430	1391	1.43	<	1	0.14	0.42	0.28	<0.1	<0.1					0.19	0.0049
2-Oct-14	11.4	66.7	31.7			245	63	9.4	297	8.04	7.74	584	597	0.021	<	1	0.08	0.77	0.69	<0.1	<0.1					0.52	0.0028
8-May-15	7.0	127	64.0			374	214	82.8	580	7.78	7.43	1170	1079	0.512	<	1	0.11	0.4	0.29	<0.1	0.2					0.13	0.0036
22-Sep-15	12.5	69.5	34.2			256	55	10.7	314	8.02	8.02	575	583	0.570	<	1	0.07	0.5	0.43	<0.1	0.1					0.84	0.0055
4-May-16	7.3	104	55.6			347	141	60.7	487	7.93	7.43	1010	1065	0.862	<	1	0.12	0.5	0.38	<							

Monitoring Well TH7-81

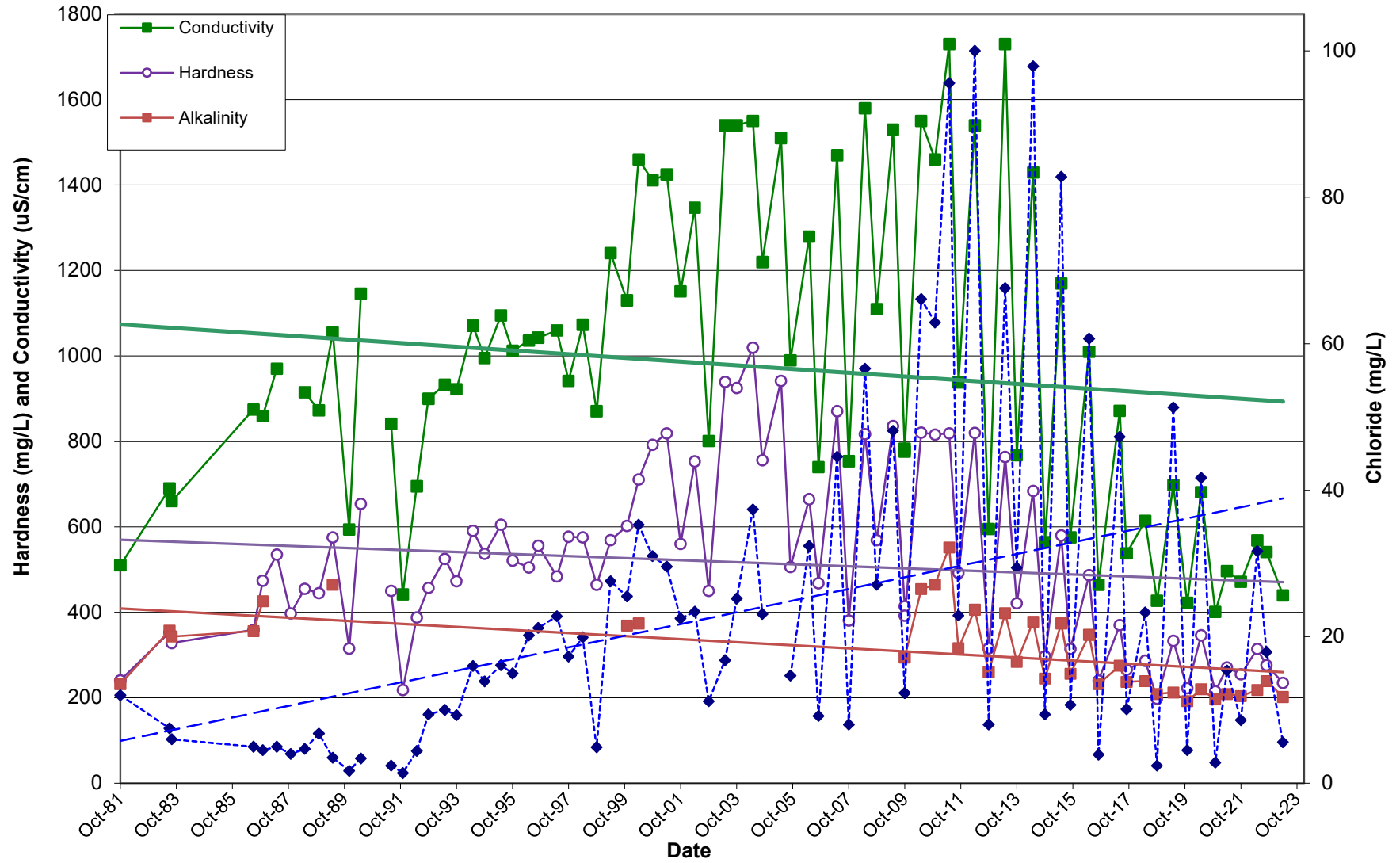

HISTORIC GROUNDWATER QUALITY DATA
Monitoring Well TH8-81

DATE	Temp (field) °C	Ca	Mg	Na	K	Alk as CaCO3	SO4	Cl	Hardness as CaCO3	pH	pH (field)	Conduct	Conduct (field)	Fe	Phenols	Free NH3 as N	TKN as N	Organic Nitrogen	NO2 as N	NO3 as N	DOC	Mn	Total P	As	o-PO4	
ODWQS				200		30 - 500	500	250	80 - 100	6.5 - 8.5	6.5 - 8.5			0.3				0.15	1***	10***	5	0.05		0.025***		
2-Aug-83		50	25.6	14.0	7.7	227	13.0	3.0	230	7.69		400		8.95	< 1	0.31	1.86									
11-Dec-89		86.4	39.1					2.8	377	7.66		460			< 1.5							BROKEN				
4-Dec-90	NOT SAMPLED																									
3-Jun-91	UNSUITABLE FOR ANALYSIS																									
19-Nov-91		50.2	31.3						2.0	254	7.57	417			18.0										1.8	
19-May-92		53.6	32.6						2.0	268	7.75	416		< 1												1.2
26-Oct-92		44.5	33.1						1.7	248	7.61	472			6.5											1.3
25-May-93		39.5	26.3						1.5	207	7.77	414		< 1	0.304											1.2
18-Oct-93		59.5	37.9						1.1	305	7.62	589			6.5	0.391										2.0
3-May-94		36.9	25.9	13.5	1.0				1.2	199	7.94	431		< 1	0.345											1.5
21-Oct-94		38.8	28.9						1.6	216	7.86	453		< 1	0.250											1.5
29-May-95		38.7	27.6						1.3	210	7.8	416			7.7	0.1										1.6
11-Oct-95		50.5	34.8						1	270	7.62	515		< 1	0.13											
9-May-96		37.3	27						2.7	204	7.66	400		< 1	0.3						< 1					1
25-Sep-96		41.5	29.9						2.7	227	7.71	420		< 1	0.5						< 1					1
8-May-97		35.5	26.2						2.3	196	7.85	408		< 1	0.35						< 1					4
23-Oct-97		54.8	49.3						3.6	340	7.5	689		< 1	0.66						< 1					1
16-Apr-98		44.0	29.2						2.5	230	7.82	729		< 1	0.40											4
21-Oct-98		50.1	32						2.1	257	7.43	515		< 1	0.47											3
21-Apr-99		58.4	38.3						3.3	303	7.84	625		< 1	0.54											7
11-Nov-99		99.7	60.2	16.2	1.7	423	159	3.0	497	7.23		1000		3.12	< 1	1.05						7	0.231			
13-Apr-00		85.9	34.5			273	58.7	3.0	357	7.5		623		0.95	< 1	0.61						6	0.181			
17-Oct-00		76.1	45.8						3.4	378	7.12	750		< 1	0.79											16
24-Apr-01		43.4	32.5						1.9	242	7.81	489		< 1	0.43											4
3-Oct-01		91.8	50.7	14.3	2.6				2.7	438	7.43	777		< 1	0.82											5
18-Apr-02		43.4	30.2	12.7	1.6				3	233	7.52	467		< 1	0.42											3
24-Oct-02		45.4	28.8						1.8	232	8.18	438		< 1	0.43											1
22-May-03		64.9	38.0						8.0	318	7.70	614		< 1	0.50											1.2
30-Oct-03		99.1	53.3						2.3	467	7.9	826		< 1	0.73	8.65	7.92	<0.1	0.1							18
20-May-04									1.9	237	7.75	463		< 1	0.4							0.8	0.093		0.026	<0.01
30-Sep-04		49.7	30.6						1.9	250	7.7	477		< 1	0.51							0.9			0.01	<0.01
5-May-05	7.7	35.7	26.1						1.9	197	6.66	8.0	418	384	< 1	0.29						0.8			0.011	<0.01
29-Sep-05	11	36.8	24.7						1.7	194	7.69	8.3	423	392	< 1	0.39	3.15	2.76				4.5			0.011	<0.01
4-May-06	8	42.2	29.9						1.9	229	7.83	8	465	450	< 1	0.4	3.65	3.25	<0.1	<0.1					4.59	0.012
28-Sep-06	11.1	51.6	33.1						1.9	265	7.51	8.2	549	551	< 1	0.51	8.79	8.28	<0.1	0.1					10.9	0.0105
10-May-07	7.5	41.7	28.5						1.5	222	7.77	8.1	462	443	< 1	0.27	7.12	6.85	<0.1	<0.1					8.95	0.0158
4-Oct-07	DRY																									
15-May-08	7.8	43.9	29.3						1.4	230	7.6	8.0	465	443	< 1	0.19	1.85	1.66	<0.1	0.1					2.73	0.0111
2-Oct-08	10.9	43.7	28.8						1.5	228	8.12	7.7	443	415	< 1	0.43	2.1	1.67	<0.1	<0.1					2.67	0.0105
21-May-09	8.2	38.5	29.5						1.4	217	7.09	8.1	453	392	< 1	0.26	7.54	7.28	<0.1	<0.1					10.5	0.0081
15-Oct-09	9.9	76.2	49.9						1.8	395	6.87	8.1	770	737	< 1	0.61	30.6	29.99	<0.1	0.1					35.7	0.0173
6-May-10	7.7	38.2	27.7						1.5	209	7.56	7.3	477	400	< 1	0.28	3.12	2.84	<0.1	<0.1					4.37	0.0079
11-Nov-10	10.2	42.3	33.1						1.3	242	7.2	8.2	473	523	< 1	0.25	2.71	2.46	<0.1	<0.1					4.32	0.0207
5-May-11	6.7	37.1	30.3				49		1.3	217	7.70	8.6	486	368	< 1	0.24	1.47	1.23	<0.1	<0.1					1.93	0.0154
29-Sep-11	13.6	34.9	26.8						1.2	198	7.80	7.8	451	416	< 1	0.26	4.34	4.08	<0.1	<0.1					6.70	0.0147
19-Apr-12	7.6	42.2	32.9						1.5	241	7.94	7.8	468	464	< 1	0.16	0.68	0.52	<0.1	0.1					0.82	0.0109
3-Oct-12	12.8	38.5	29.4						1.3	217	8.11	8.31	428	457	< 1	0.13	2.63	2.7	<0.1	0.2					4.87	0.0097
2-May-13	9.6	46.0	33.0						1.5	251	8.08	7.75	453	413	< 1	24	0.19	1.35	1.16	<0.1	<0.1				1.65	0.0101
3-Oct-13	12.1	62.3	41.9						1.2	328	7.96	7.55	580	512	< 1	0.40	1.31	0.91	<0.1	<0.1					1.47	0.0194
7-May-14	6.7	39.4	30.4						1.3	223	8.17	7.84	466	457	< 1	0.18	0.58	0.40	<0.1	<0.1					0.56	0.0076
2-Oct-14	12.0	64.9	43.6						1.2	342	8.05	7.74	596	580	< 1	0.36	0.92	0.56	<0.1	<0.1					0.86	0.0109
6-May-15	8.3	48.0	36.5						1.4	270	8.02	7.92	464	443	< 1	0.17	1.2	1.03	<0.1	<0.1					1.97	0.0114
22-Sep-15	12.3	59.6	42.9						1.2	325	8.02	8.31	574	577	< 1	0.31	5.5	5.19	<0.1	0.1					12.3	0.0121
4-May-16	7.58	44.8	37.9				66		1.5	268	8.09	7.81	518	536	0.054	< 1	0.24	0.6	0.36	<0.1	0.2				0.01	0.0123
28-Sep-16	12.7	42.5	32.3				43		0.8	239	8.05	7.85	481	449	0.051	< 1	0.16	0.36	0.2	<0.1	0.2				<0.01	0.0116
5-Jun-17	9.2	45.8	35.6						51	1.2	261	8.01	7.71	515	490	<0.005	3	0.03	0.4	0.37	<0.05	<0.05			<0.01	0.0069
27-Sep-17	12.4	79.6	51.1						50	1.3	409	8.14	7.49	630	509	0.970	< 1	0.30	0.6	0.3	<0.05	<0.05			0.01	0.0078
15-May-18	8.3	41.4	35.6						67	0.7	250	8.17	7.77	511	495	0.044	< 1	0.31	11.0	10.69	<0.05	0.20			14.	

Monitoring Well TH8-81

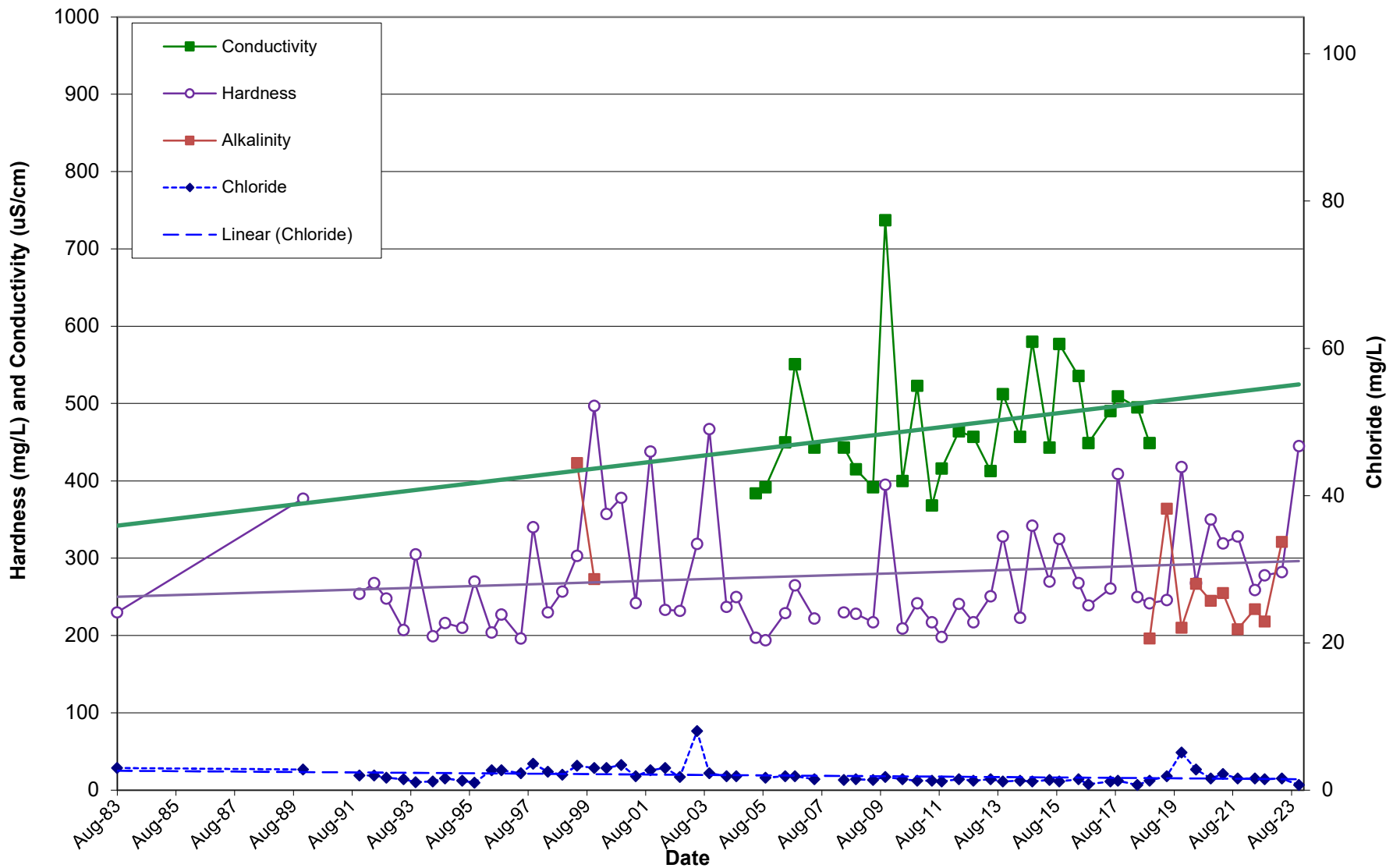

HISTORIC GROUNDWATER QUALITY DATA
Monitoring Well TH4-81

DATE	Temp (field) °C	Ca	Mg	Na	K	Alk. as CaCO ₃	SO ₄	Cl	Hardness as CaCO ₃	pH	pH (field)	Conduct.	Conduct. (field)	Fe	Phenols	Free NH ₃ as N	TKN as N	NO ₂ as N	NO ₃ as N	DOC	Mn	
ODWQS				200		30 - 500	500	250	80 - 100	6.5 - 8.5	6.5 - 8.5			0.3				1***	10***	5	0.05	
16-Oct-81		104	83	28	1.5	570	52	30	600	7.7		1100		0.02	-	-	-					
19-Nov-87		101.4	84.8					2.87	603	7.62					< 1						3.5	
19-May-88		84.4	70.8					5.34	503	8.1		865			< 1						4.4	
2-Nov-88		91.8	84.6					3.3	578	7.29		982			< 1						4.7	
24-May-89		88	78	8.04	0.7	499	42.5	5.1	541	7.4		941		0.79	1.0	0.162	0.1				3.0	0.55
11-Dec-89		101	83					5	594	7.46		1034			< 1						2.7	
16-May-90		268	114					13.9	1140	7.46		858			1.0						2.3	
4-Dec-90		86.2	68					3.4	496	7.39		868			< 1						3.0	
3-Jun-91		80.7	66					6.9	474	7.47		812			< 1						2.3	
19-Nov-91		84.3	71					6.6	503	7.38		908			6.5						2.8	
19-May-92		77.4	63.5					9.0	455	7.43		789			< 1						2.3	
26-Oct-92		70.0	77.6					6.3	495	7.61		904			4.5	0.142					2.4	
25-May-93		83.4	63.1					4.8	468	7.37		827			4.0	0.090					1.8	
18-Oct-93		81.2	68.3					3.7	484	7.34		886			3.5	0.134					2.6	
3-May-94		71.7	56.1	6.1	0.3			4.3	410	7.55		753			3.8	0.107					2.3	
21-Oct-94		78.2	64.9					5.2	463	7.50		791			< 1	0.097					2.4	
29-May-95		67.5	59.7					3.2	415	7.48		737			1.9	0.04					2.4	
11-Oct-95		69.7	63					4	434	7.54		785			< 1	0.09						
9-May-96		78	51.1					5.2	405	7.22		698			< 1	0.05				<	1	
25-Sep-96		72.9	56					5.1	412	7.53		738			< 1	0.13				<	1	
8-May-97		66.5	49.4					5.6	369	7.43		674			< 1	0.10					4	
23-Oct-97		73.4	48.2					6.7	382	7.72		716			< 1	0.12					3	
16-Apr-98		82.4	53.8					7.2	427	7.57		745			< 1	0.06				<	1	
21-Oct-98		126	73					49	615	7.43		1096			< 1	0.12					8	
21-Apr-99		78.6	44.9					25.7	381	7.67		878			< 1	0.02					9	
11-Nov-99		118	65	18	<1.0	447	69.7	42.2	562	7.37		1010		0.03	< 1	<0.01				<	1	0.032
13-Apr-00		118	62			420	50.6	22.5	550	7.35		935		0.12	< 1	<0.01				<	1	0.294
17-Oct-00		114	67.4					14.7	562	7.08		980			< 1	0.05					19	
24-Apr-01		92.7	69					15.5	515	7.33		937			< 1	0.07					6	
3-Oct-01		113	62.4	10.9	1.0			12.1	539	7.27		988			< 1	0.17					6	
18-Apr-02		Decommissioned																				
Average		94.1	67.4	14.2	0.9	484	53.7	11.1	513	7.47		870		0.24	1.6	0.10					3.7	0.292
Maximum		268	114	28	1.5	570	69.7	49	1140	8.1		1100		0.79	6.5	0.17					19	0.550
Minimum		66.5	44.9	6.1	0.3	420	42.5	2.87	369	7.08		674		0.02	1	0.02					1	0.032
Count		30	30	5	5	4	4	30	30	30		29		4	30	21					28	3

All results expressed as mg/L except the following parameters

pH as -log [H⁺]

phenols as ppb

conductivity as µS/cm

1983 data is from CRA Hydrogeological Investigation (1984)

* Monitoring well TH4-81 was decommissioned in 2002 and replaced in the monitoring program by TH4-02.

*** Standard related to health.

**APPENDIX F:
SUMMARY OF SURFACEWATER ANALYTICAL RESULTS
(TABLES & GRAPHS)**

Historic Surface Water Quality Data Sample SP1-83

DATE	Temp (°C) (field)	Calcium	Magnesium	Sodium	Potassium	Alkalinity as CaCO3	Sulphate	Chloride	Hardness as CaCO3	pH	Conduct.	Iron	Phenols	Ammonia as N	Unionized Ammonia as NH3 ****	TKN as N	Organic Nitrogen	Nitrite as N	Nitrate as N	DOC	Magnese	Total Phosphorus	Arsenic
PWQO										6.5 - 8.5		0.3	1		0.02							0.03	0.005
18-May-77 ***																							
27-Jul-77 ***		86	39.6	15.2	12.20	407	29	27.5	412	7.38	843	0.32		1.90		2.80	0.90	0.047					
7-Apr-81 ***		92	40.4	12.5	9.05	373	41	18	396	7.31	790	1.5		1.32		1.64	0.32	0.004					
5-May-81 ***		93.5	39.8	11.5	8.75		38	17.5	398	7.34	765	0.32		1.42		1.61	0.19	0.019					
13-May-82		102	32	8.7	6.70	352	50	15	388	7.6	710	0.03					0.00						
18-Jul-83		103	41.2	10.8	8.55	370	41.0	17.5	427	7.31	800	1.3		1.20			1.20						
2-Aug-83		98	39.6	10.5	8.55	366	44.0	16.5	408	7.35	895	1.38					0.00						
9-Jul-86		82.50	36.20	8.5	5.10	335	47.50	13.50	355	7.42	780	0.42	< 1	47.50		0.61	46.90	0.78	<0.01	1.5			
13-Nov-86		95.50	38.20	9.0	6.05	348	49.00	14.00	396	7.51	665	0.74	< 1	49.00		1.20	47.80	1.36	<0.01				
5-May-87		93.50	36.60					13.00	385	7.34	785		< 1			0.50	0.50	0.71	0.01		2.1		
19-Nov-87		94.80	37.42					13.01	311	7.58	735		< 1			0.47	0.47				1.2		
19-May-88		88.80	35.91					11.61	370	7.91	735		< 1			0.41	0.41				1.7		
2-Nov-88		86.00	34.39					13.81	357	7.12	751		< 1			0.60	0.60				1.5		
24-May-89		91.00	36.00					13.60	376	7.17	754		< 1			0.53	0.53				1.4		
11-Dec-89		97.3	38.2					14.2	402	8.02	739		< 1	0.567						2.3			0.007
16-May-90								13.8		7.26	740		< 1	0.617						1.9			0.003
4-Dec-90		93.6	36.1					13.8	383	7.28	759		< 1	0.614						2.5			0.014
4-Dec-90 *		90.1	34.6					13.5	368	7.35	757		< 1	0.637						2.4			0.0004
3-Jun-91		90.6	34.6					13.3	369	7.29	724		< 1	0.573						1.9			0.003
19-Nov-91		91.5	38.7					13.7	388	7.81	751		< 1	0.423						2.2			0.003
19-May-92		95.8	39.5					14.7	402	7.26	755		< 1	0.507						2.1			0.003
19-May-92 *		90.3	39.9					14.7	390	7.43	757		< 1	0.511						2.2			0.005
26-Oct-92		91.6	41.6	9.9	6.3	322	39.0	14.3	401	7.55	767	0.18	< 1	0.163		0.78	0.62	<0.01	2.6				0.008
25-May-93		95.1	35.3	8.5	5.3	366	38.4	14.2	383	7.25	758	0.76	< 1	0.61		0.92	0.31	<0.01	3.0				0.005
18-Oct-93		90.8	38.6	9.3	5.6	346	49	13.5	386	7.31	766	0.7	< 1	0.54		0.91	0.37	<0.01	2.5				0.003
3-May-94		99.1	39.2	9.2	5.6	345	38.8	14.2	409	7.74	785	1.36	< 1	0.45		0.93	0.48	0.03	1.9				0.006
21-Oct-94		92.7	43.5	12.0	6.88	336	37.5	9.2	411	7.52	805	1.95	< 1	0.59		1.14	0.55	0.02	1.2				0.015
21-Oct-94 *		90.0	42.7	12.1	6.96	309	37.2	16.6	401	7.52	806	1.79	< 1	0.63		1.13	0.50	0.02	1.2				0.003
29-May-95		86.8	42.7	10.6	7.63	378	44.8	14.1	393	7.27	798	1.85	< 1	0.89		1.18	0.29	<0.01	1.5				0.06
29-May-95 *		88.6	42.2	10.3	7.55	377	44.7	14.0	395	7.32	797	2.81	< 1	0.04		1.24	1.20	<0.01	1.5				0.05
11-Oct-95		93.8	42.9	10.9	7.96	348	42.9	15.5	411	7.27	810	3.67	< 1	0.89		1.33	0.44	0.01	1.7				0.01
9-May-96		114	47.3	10.5	7.7	387	39.7	14.0	479	7	798	1.68	< 1	0.83		0.95	0.12	<0.1	1.7		0.106		<0.1
25-Sep-96		102	39.5	9.6	7.5	349	40.8	14.4	417	6.96	797	0.13	< 1	0.87		1.15	0.28	<0.1	1.8		0.087		<0.1
8-May-97		98.7	37.8	6.6	4.9	348	38.4	12.9	401	7.1	778	1.81	< 1	0.65		0.88	0.23	<0.1	1.7				<0.1
23-Oct-97		98.0	42.2	8.9	6.9	357	38.5	13.0	418	7.09	766	1.43	< 1	0.77		0.95	0.18	<0.1	1.9		0.053		<0.025
16-Apr-98		105	41.9	9.0	6.5	360	42.2	12.8	435	7.16	785	1.40	< 1	0.61		0.65	0.04	<0.1	2.2		0.055		0.01
16-Apr-98 *		105	41.9	9.2	6.6	365	42.5	12.9	435	7.17	786	1.39	< 1	0.61		0.65	0.04	<0.01	2.2		0.054		0.01
21-Oct-98		105	36.1	8.8	5.8	357	48.6	13.2	411	6.77	792	1.38	< 1	0.50		0.62	0.12	<0.1	2.4		0.053		<0.01
21-Oct-98 *		105	35.8	8.3	5.8	357	48.4	13.1	410	6.76	792	1.40	< 1	0.50		0.63	0.13	<0.1	2.4		0.053		<0.01
21-Apr-99		100	36.9	8.4	7.5	347	43.4	13.0	402	7.33	797	1.42	< 1	0.46		0.57	0.11	<0.1	2.2		0.05		<0.01
21-Apr-99 *		104	39	8.5	6.9	354	43.5	13.0	420	7.2	796	1.42	< 1	0.46		0.57	0.11	<0.1	2.2		0.05		<0.01
11-Nov-99		102	36	9	5.9	370	44.9	14.7	403	7.11	801	1.48	< 1	0.37		0.37	0.00	<0.1	2.2		0.05		<0.01
11-Nov-99 *		99.7	36.2	8.9	5.8	377	44.8	14.7	398	7.07	798	1.44	< 1	0.34		0.37	0.03	<0.1	2.2		0.05		<0.01
13-Apr-00		122	30.9	9.9	6.4	366	36.9	12.6	432	7.14	804	1.67	< 1	0.38		0.54	0.16	<0.1	2.0	4	0.058		<0.01
13-Apr-00 *		108	35.9	9.3	6.0	364	37.0	12.5	418	7.12	806	1.68	< 1	0.38		0.51	0.13	<0.1	2.0	1	0.059		<0.01
17-Oct-00		105	39	9.43	5.73	360	34.7	12.6	423	6.9	792	1.59	< 1	0.37		0.52	0.15	<0.1	2.5		0.056		0.03
17-Oct-00 *		108	39.2	10	6.19	364	34.8	12.6	440	6.89	791	1.46	< 1	0.38		0.55	0.17	<0.1	2.6		0.051		0.03
24-Apr-01		96	39.8	7.9	4.8	355	37.2	14.2	404	7.17	802	6.07	< 1	0.4		0.66	0.26	<0.1	2.3				0.114
24-Apr-01 *		96.9	39.2	7.6	5.3	355	37.2	13.8	403	7.43	802	21.1	< 1	0.4		0.58	0.18	<0.1	2.3				0.171
3-Oct-01		111	43.3	13.7	8.6	392	39.6	15.4	455	7.09	807	1.35	< 1	0.53		0.79	0.26	<0.1	3.5				
3-Oct-01 *		105	39.9	10.3	7.8	389	40	15.4	426	7.06	807	1.19	< 1	0.52		0.71	0.19	<0.1	2.7				
18-Apr-02		104	41.6	10.8	6.4	373	41.4	14.7	431	7.02	808	1.35	< 1	0.42		0.54	0.12	<0.1	2.5				
18-Apr-02 *		103	41.0	10.3	6.5	372	41.5	14.7	426	7.03	804	1.35	< 1	0.4		0.54	0.14	<0.1	2.5				
24-Oct-02		117	43	10.8	5.8	363	42	16.8	469	7.75	805	1.16	< 1	0.42		0.54	0.12	<0.1	2.4		0.05		0.01
22-May-03		111	39.5	11.6	6.9	361	41	16.8	440	7.54	815	0.50	< 1	0.66		0.89	0.23	<0.1	2.2		0.06		<0.01
30-Oct-03		110	38.8	12.3	6.6	423	40	17.8	434	7.72	857	2.42	< 1	0.91		1.14	0.23	<0.1	2.1		0.15		<0.01
20-May-04		106	35.9	9	5.5	354	43	14.2	413	7.22	742	1.13	< 1	0.4		0.51	0.11	<0.1	2.5		0.062		

Historic Surface Water Quality Data Sample SP1-83

DATE	Temp (°C) (field)	Calcium	Magnesium	Sodium	Potassium	Alkalinity as CaCO3	Sulphate	Chloride	Hardness as CaCO3	pH	Conduct.	Iron	Phenols	Ammonia as N	Unionized Ammonia as NH3 ****	TKN as N	Organic Nitrogen	Nitrite as N	Nitrate as N	DOC	Magnese	Total Phosphorus	Arsenic	
PWQO										6.5 - 8.5		0.3	1		0.02							0.03	0.005	
28-Sep-06	9.8	107	38	9.5	5.1	378	40	16.8	423	7.23	757	0.761	< 1	1	0.18	0.00247	0.25	0.07	<0.1	2.5		<0.01	0.0005	
10-May-07	9.3	102	36.6	9.6	5.4	388	39	16.1	406	7.61	700	0.929	< 1	1	0.26	0.00138	0.35	0.09	<0.1	2.4		<0.01	0.001	
4-Oct-07	10.0	72.6	29.7	7.9	3.9	216	35	16.9	304	7.53	573	0.79	< 1	1	0.1	0.00140	0.32	0.22	<0.1	2.3		<0.01	<0.0005	
15-May-08	9.6	113	40.6	11	5.6	376	39	17.6	449	7.23	742	1.24	< 1	1	0.26	0.00141	0.46	0.20	<0.1	2.3		<0.01	<0.0005	
2-Oct-08	10.3	98.8	34.7	16.2	6.4	381	38	23.5	390	7.81	718	0.725	< 1	1	0.68	0.00490	0.79	0.11	0.3	2.4		<0.01	0.001	
21-May-09	10.1	107	37.9	11.9	5.8	369	37	20.7	422	7.12	816	1.25	< 1	1	0.43		0.54	0.11	<0.1	2.2		<0.01	<0.0005	
21-May-09 *		107	37.9	11.9	5.7	369	37	20.6	423	7.21	819	1.2	< 1	1	0.44		0.54	0.10	<0.1	2.3		<0.01	<0.0005	
15-Oct-09	9.9	106	40.2	13.7	6.7	383	37	24.1	431	6.88	812	2.04	< 1	1	0.83	0.01150	1.05	0.22	<0.1	2.2		<0.01	<0.0005	
15-Oct-09 *		104	39.6	13.4	6.6	383	37	24.2	424	6.95	803	1.07	< 1	1	0.85		1.04	0.19	<0.1	2.2		<0.01	<0.0005	
6-May-10	8.9	109	38.5	12.7	5.5	354	37	22.3	432	7.29	818	1.19	< 1	1	0.5	0.00129	0.59	0.09	<0.1	2.3		<0.01	0.0007	
11-Nov-10	10.0	117	42.2	18.2	6.8	393	36	30.1	467	7.27	882	1.48	< 1	1	1.15	0.01278	1.37	0.22	<0.1	2.2		<0.01	0.0007	
5-May-11	8.9	113	40.7	18.5	6.7	406	33	32.0	451	7.22	902	2.53	< 1	1	1.55	0.03921	1.64	0.09	<0.1	1.9		<0.01	0.0015	
29-Sep-11	14.4	207	54.8	32.4	15.2	520	17	41.1	742	7.39	1110	342	4	7.40	0.01844	12.7	5.30	<0.1	<0.1		1.01	0.0238		
19-Apr-12	9.4	102	39.1	18.7	7.4	395	33	30.7	416	7.54	861	1.26	< 1	1	1.18	< 0.02	1.47	0.29	<0.1	1.8		<0.01	0.0012	
4-Oct-12 No Flow	14.1	141	46.6	26.4	13.1	569	15	41.9	544	7.74	1120	32.8	< 1	1	5.78	0.03	7.85	2.07	<0.1	0.1		0.17	0.0037	
2-May-13	8.4	101	35.2	15.1	5.7	383	34	24.3	397	7.82	801	1.34	< 1	1	0.94	< 0.02	1.32	0.38	<0.1	1.8		<0.01	0.0006	
3-Oct-13	12.7	104	37.5	19.7	6.8	404	28	29.2	415	7.58	758	0.088	< 1	1	1.23	< 0.02	1.50	0.27	<0.1	1.5		<0.01	0.0005	
7-May-14	8.7	95.4	34.9	14.8	5.1	370	33	24.6	382	7.12	766	1.51	< 1	1	0.85	< 0.02	1.06	0.21	<0.1	1.7		<0.01	0.0010	
7-May-14 *		96.2	35.4					24.3	386	7.81	756		< 1	1	0.85		1.05	0.20	<0.1	1.7		<0.01	0.0008	
2-Oct-14	11.5	95.8	33.3	17.1	5.6	356	29	27.1	376	7.84	773	1.07	< 1	1	0.71	< 0.02	0.89	0.18	<0.1	1.7		<0.01	0.0006	
6-May-15	8.2	101	35.4	16.1	5.7	378	31	22.8	398	7.80	774	0.993	< 1	1	0.88	< 0.02	1.1	0.22	<0.1	1.9		0.02	0.0006	
22-Sep-15	13.0	109	37.9	20.2	6.6	399	28	26.7	429	7.77	832	0.718	< 1	1	1.14	0.03	1.4	0.26	<0.1	1.5		<0.01	0.0006	
4-May-16	7.8	103	41.5	21.5	7.7	427	27	25.8	429	7.62	827	4.07	< 1	1	2.91	< 0.02	3.29	0.38	<0.1	1.4		<0.01	0.0010	
28-Sep-16	13.7	120	41.7	26.4	9.7	501	16	32.9	472	7.72	991	1.43	< 1	1	4.61	< 0.02	5.14	0.53	<0.1	<0.1		<0.01	0.0003	
5-Jun-17	9.5	104	36.5	16.3	5.3	366	25	17.7	409	7.79	810	1.01	< 1	1	0.83	< 0.02	0.9	0.07	<0.05	1.74		<0.01	0.0006	
27-Sep-17	10.9	99.3	37.0	16.3	5.7	361	23	20.6	400	7.77	795	0.886	< 1	1	0.69	< 0.02	0.86	0.17	<0.05	2.02		<0.01	0.0005	
15-May-18	9.2	92.2	36.9	15.8	5.2	371	32	21.0	382	7.72	757	1.15	< 1	1	0.60	< 0.02	0.7	0.10	<0.05	1.75		<0.01	0.0007	
3-Oct-18	10.7	111	38.3	15.0	4.8	340	29	19.4	435	7.63	790	1.69		2	0.34	< 0.02	0.4	0.06	<0.05	1.8		0.02	0.0007	
30-May-19	9	110	36	12.8	4.4	349	33	19.7	423	8.07	771	0.667	< 0.02	1	0.51	< 0.02	0.5	0.01	< 0.05	1.9		0.03	0.0004	
25-Nov-19	7.5	104	34.5	13	4.7	343	31	22.7	402	7.88	777	0.81	< 0.02	1	0.51	< 0.02	0.60	0.09	<0.05	2.09		< 0.01	0.0004	
20-May-20																								
6-Nov-20		107	33.4	12.9	4.9	354	28	19.5	405	7.88	774	1.05	< 0.002	1	0.5	0.01	1.8	1.3	< 0.05	2.01		0.11	0.0005	
8-Apr-21	10	98.4	35.3	12.7	4.9	363	27	19.1	391	7.95	786	1.34	< 0.002	1	0.68	0.00	0.8	0.12	0.07	2.03	2.8	< 0.01	0.0005	
7-Oct-21	12	82.6	35.1	9.9	3.6	368	28	19.7	351	8.16	752	0.017	< 0.002	1	0.04	0.00	0.2	0.16	0.05	1.88		< 0.01	0.0002	
11-May-22	7	103	35.6	14.1	5.1	389	30	28.1	404	8.05	804	3.72	< 0.001	1	0.94	0.02	1.1		< 0.05	2.06	2.3	< 0.01	0.0019	
15-Sep-22																								
11-Apr-23	5	112	36.7	13.7	5.2	373	23	22.6	442	8.07	811	< 0.005	< 0.001	1	1.07	0.02	2.3		< 0.05	1.7	2.7		0.16	0.0106
2-Nov-23																								
Average	10.24	102.24	38.73	12.33	6.66	372.62	37.71	17.77	414.54	7.36	792.92	6.66	1.38		2.03	0.01578	1.16	0.34	0.30	2.08	1.80	0.06	0.06	0.002
Maximum	14.4	207	54.8	32.4	15.2	569	50	41.9	742	8.02	1120	342	9.5		49	0.03921	12.7	5.3	1.36	3.5	4	0.15	1.01	0.0238
Minimum	7.8	72.6	29.7	6.6	3.9	216	15	9.2	304	6.76	573	0.03	1		0.04	0.00129	0.25	0.01	0.004	0.01	1	0.044	0.0004	0.0003
Count	28	87	87	74	74	73	74	88	87	88	88	74	82		81	27	77	45	73	78	8	22	71	33

* denotes duplicate sample

** result not valid due to excessively corroded sample bottle cap,
duplicate used in graph

*** Sample from SP3 in 1984 Hydrogeological Investigation by CRA. Sample location SP3 is reportedly
the same location as SP1-83

****Fraction (f) of NH3 where $f = 1/(10^{pH-pKa} + 1)$; $pKa = 0.09018 + 2729.92/T$; $T = °C + 273.15$

All results expressed as mg/L except the following parameters:

pH as -log [H+]
phenols as ppb
conductivity as $\mu S/cm$

Surface Water Sample SP1-83

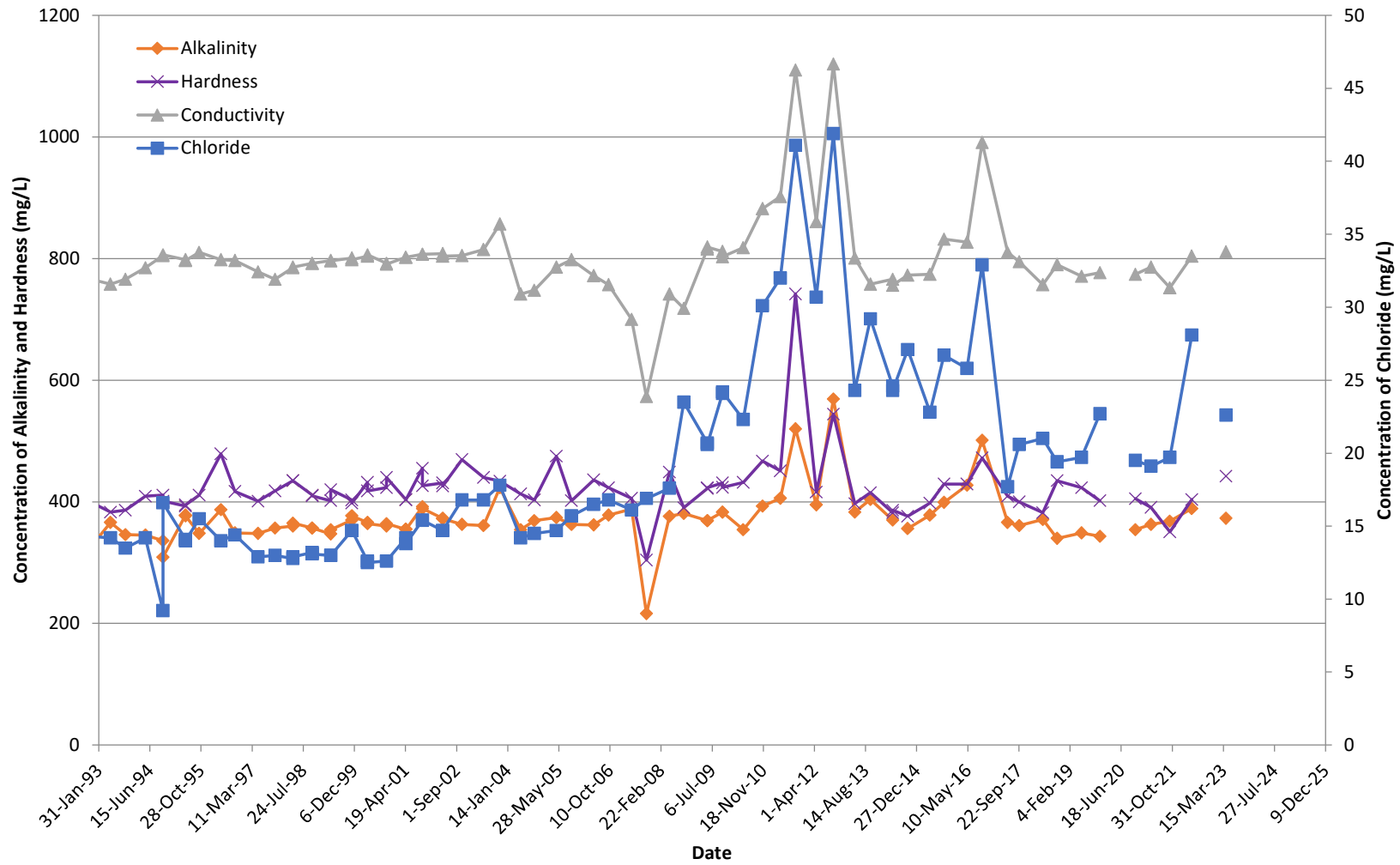

Historic Surface Water Quality Data
Sample SP2-83

DATE	Temp (°C) (field)	Ca	Mg	Na	K	Alk. as CaCO3	SO4	Cl	Hardness as CaCO3	pH	Conduct.	Fe	Phenols	NH3 as N	Unionized Ammonia as NH3 ****	TKN as N	Organic Nitrogen	NO2 as N	NO3 as N	DOC	Mn	Total P	As	0-PO4
PWQO										6.5 - 8.5		0.3	1		0.02							0.03	0.005	
18-May-77																								
27-Jul-77		74	32.8	7.5	3.9	322	38.5	14.0	356	7.60	668	0.7		0.035		0.310		0.015						
5-May-81		89	38	7.9	4.45	334	41	12	179	7.51	700	0.06		0.015		0.13		0.003						
9-Jul-86																								
13-Nov-86		96.00	30.20	12.0	1.65	367	14.00	8.00		8.07	705	0.38	< 0.1	0.055		0.41		<0.010	0.1			0.170		
5-May-87																								
19-Nov-87		136.80	52.18					20.48	557	7.81	975		< 0.1	0.016					0.3	7.2				
19-May-88		109.40	57.42					28.84	510	8.07	1070		< 1	0.190					<0.1	8.5				
2-Nov-88		131.60	55.82					40.75	559	7.61	1112		< 1	0.036					0.3	7.6				
24-May-89		104.00	44.80					9.80	445	7.48	721	2.20	1.5	0.002					0.1					
11-Dec-89		238	84					58.2	941	7.51	1205		< 1	0.017					1.2			3.5		
16-May-90								8.7		7.66	320		4	0.008					0.7			0.148		
4-Dec-90		106	48.2					87.9	464	7.77	1123		< 1	0.015					0.6			0.046		
3-Jun-91		142	77	22.7	12.1	501	120	28.9	672	7.83	1184	0.95	< 1	0.019					<0.1			0.205		
19-Nov-91		NO SAMPLE TAKEN - STAGNANT																						
19-May-92		132	95.5					46.8	723	7.70	1400		8.0	0.042					<0.1			0.25		
26-Oct-92		116	70.3					35.9	578	7.87	1088		2.5	0.010					0.5			0.280		
25-May-93		110	60.6					30.3	525	8.17	1034		3.5	0.101					0.4			0.056		
18-Oct-93		117	51.4					30.4	506	7.94	983		3.5	0.039					0.3			0.08		
3-May-94		106	51.2	14.2	10.9			22.0	478	8.20	921		< 1	0.005		0.74		<0.01	0.3			0.038		
21-Oct-94		93	65.4					44.1	502	8.18	967		4.8	0.005		1.09		0.02	0.2			0.104		
29-May-95		105	91.3					43	641	8.11	1148		4.9	0.04		4.32		<0.01	<0.1			0.59		
11-Oct-95	DRY																							
9-May-96		108	62.9					27.1	529	7.95	945		1	0.02		0.03		<0.1	<0.1			0.02		
25-Sep-96		17.8	3.6					3.3	59	7.73	127		1	0.03		0.41		<0.1	<0.1			0.08		
8-May-97		98.7	42.8					21.2	423	7.65	836		< 3	0.03		1.26		<0.1	<0.1			0.16		
23-Oct-97		94	54					65	457	7.61	993		< 1	0.53		1.3		<0.1	0.4			0.08		
16-Apr-98		103	42.7					15.3	433	7.84	773		< 1	0.65		1.19		<0.1	0.4			0.04		
21-Oct-98		21.5	5.3					6.4	76	7.24	150		2	<0.01		0.34		<0.1	0.4			0.22		
21-Apr-99		113	47.3					30.2	477	7.77	988		< 1	0.09		0.67		<0.1	<0.1			0.08		
11-Nov-99		121	91.3	35.8	24.3	475	243	75.5	678	7.69	1410	0.38	< 1	0.03		1.07		0.3	<0.1		0.101	0.04		
13-Apr-00		150	63.7			536	77.1	49.1	637	7.45	1270	0.56	19	2.56						60	0.245			
17-Oct-00		88.3	81.4					67.1	555	7.85	1458		18	5.72		8.48	2.76	<0.1	<0.1			0.73		
24-Apr-01		70.2	32				26.4	15.4	307	7.98	583		< 1	0.17		0.5	0.33	<0.1	0.9					
3-Oct-01		562	347	255	154			*336	*2831.17	6.89	*5500		701	79.8		148	68.2	<0.1	<0.1					
18-Apr-02		107	51.8	22.4	13.1			27.6	480	7.17	943		10	2.36		4.5	2.14	<0.1	<0.1					
24-Oct-02		DRY																						
22-May-03		123	77.3					27.3	625	7.79	1190		< 1	4.20		8.15	3.95	<0.1	0.1			0.69		
30-Oct-03		125	64.3					61.5	577	8.02	1200		< 1	2.65		4	1.35	<0.1	0.2			0.08		
20-May-04		127	70.2					64.9	606	7.56	1130		< 1	7.76		15.1	7.34	<0.1	0.2			1.98	0.005	0.07
30-Sep-04		103	47.2					13.1	453	7.61	764		< 1	0.04		0.25	0.21	<0.1	<0.1			0.08	0.002	<0.01
5-May-05		10.7	140	62.9					609	7.7	1090		5	1.7	0.03144	3.4	1.7	<0.1	<0.1			0.32	0.002	0.07
29-Sep-05		11.3	62.2	28.2					155	7.6	1080		< 1	0.26	0.05353	1.68	1.42	<0.1	0.6			0.12	0.001	<0.01
4-May-06	DRY																							
28-Sep-06	DRY																							
10-May-07		13.3	97.6	27.5				67	357	7.81	755		< 1	0.15	0.00171	0.94	0.79	0.2	1.8			0.12	0.0016	
4-Oct-07	DRY																							
15-May-08		11.3	120	32.3				47.9	434	7.49	760		< 1	0.04	0.00049	0.83	0.79	<0.1	0.4			0.12	0.0021	
2-Oct-08	DRY																							
21-May-09	NO FLOW																							
15-Oct-09		4.5	121	43.8				40.5	483	7.13	905		< 1	< 0.01	< 0.00022	0.35	0.35	<0.1	0.3			0.02	<0.0005	
6-May-10		9.2	148	48.5				58.1	580	7.52	956		< 1	0.55	0.00230	3.12	2.57	<0.1	0.4			0.8	0.0029	
11-Nov-10		2.1	161	49.5				62.1	605	7.48	1090		< 1	0.42	0.00775	1.06	0.64	<0.1	0.1			0.14	0.0015	
5-May-11		7.9	120	35.2				32.9	446	7.64	869		< 1	0.44	0.00415	0.86	0.42	<0.1	0.3			0.11	0.0011	
29-Sep-11	DRY																							
20-Apr-12		7.8	120	39.6				54.2	463	7.80	987		< 1	0.06	< 0.02	1.43	1.37	<0.1	0.3			0.51	0.0032	
3-Oct-12	NO FLOW	10.7	138	24.8				46.3	446	7.91	805		< 1	< 0.01	< 0.02	0.72	0.72	<0.1	<0.1			0.83	0.0090	
2-May-13		10.9	98.8	25.0				18.2	350	8.04	695		< 1	0.18	< 0.02	0.72	0.54	<0.1	0.3			0.04	0.0006	
3-Oct-13		8.1	154	40.4				61.0	550	7.55	1070		< 1	< 0.01	< 0.02	7.86	7.86	<0.1	<0.1			3.59	0.0069	
7-May-14		6.2	94.1	24.6				79.1	336	7.36	800		< 1	0.06	< 0.02	0.37	0.31	<0.1	0.4			0.03	0.0005	
2-Oct-14		13.2	155	34.2				115	527	7.96	1150		< 1	0.46	< 0.02	1.35	0.89	<0.1	0.1			0.17	0.0022	
6-May-15		7.7	96.4	24.4				185	341	7.97	1050		< 1	< 0.01	< 0.02	0.8	0.8	<0.1	0.2			0.12	0.0005	
22-Sep-15		13.3	148	37.1				182	522	7.73	1400		< 1	< 0.01	< 0.02									

**Historic Surface Water Quality Data
Sample SP2-83**

DATE	Temp (°C) (field)	Ca	Mg	Na	K	Alk. as CaCO3	SO4	Cl	Hardness as CaCO3	pH	Conduct.	Fe	Phenols	NH ₃ as N	Unionized Ammonia as NH ₃ ****	TKN as N	Organic Nitrogen	NO ₂ as N	NO ₃ as N	DOC	Mn	Total P	As	0-PO4
PWQO										6.5 - 8.5		0.3	1		0.02							0.03	0.005	
3-Oct-18	11.2	132	26.4					114	439	7.72	982		3	0.05	< 0.02	1.1	1.05	<0.05	0.12			0.29	0.0016	
25-Nov-19	2.0	118	30.4			337	21	88.4	420	8.04	946	0.916	< 0.002	0.73	< 0.02	1.5	0.77	< 0.05	4.79			0.09	0.0004	
20-May-20																								
6-Nov-20																								
8-Apr-21																								
7-Oct-21																								
11-May-22																								
15-Sep-22																								
11-Apr-23	7	94.7	22.5	18.5	1.8	295	7.0	37.1	329	8.2	684	0.282	< 0.001	0.02	0.0005	0.2		< 0.05	1.64	1.8		0.03	0.0006	
2-Nov-23	6	114	27.3	30.2		409	6.0	54	397	8.02	879	2.27	< 0.001	0.65	0.009	1.1		< 0.05	1.68	6.8		0.07	0.0008	
Average	10.18	122.55	52.96	47.2	28.1	423	80.00	58.20	524	7.73	1042	0.75	15.1	2.054	0.01824	5.92	4.56	0.098	0.4	20.8	0.17	0.670	0.004	0.07
Maximum	15.9	562	347	255	154	536	243	336	2831	8.2	5500	2.2	701	79.8	0.05353	148	68.2	0.3	1.8	60	0.245	12.8	0.0416	0.07
Minimum	2.1	17.8	3.6	7.5	1.65	322	14	3.3	59	6.89	127	0.06	0.1	0.002	0.00022	0.03	0.21	0.003	0.1	7.2	0.101	0.02	0.0005	0.07
Count	23	57	56	8	8	6	7	56	55	57	57	7	55	57	22	44	30	44	54	4	2	47	24	4

All results expressed as mg/L except the following parameters:

pH as -log [H⁺]

phenols as ppb

conductivity as µS/cm

1983 data is from CRA Hydrogeological Investigation (1984)

****Fraction (f) of NH3 where $f = 1 / (10^{pH - pKa} + 1)$; $pKa = 0.09018 + 2729.92/T$; $T = °C + 273.16$

Surface Water Sample SP2-85

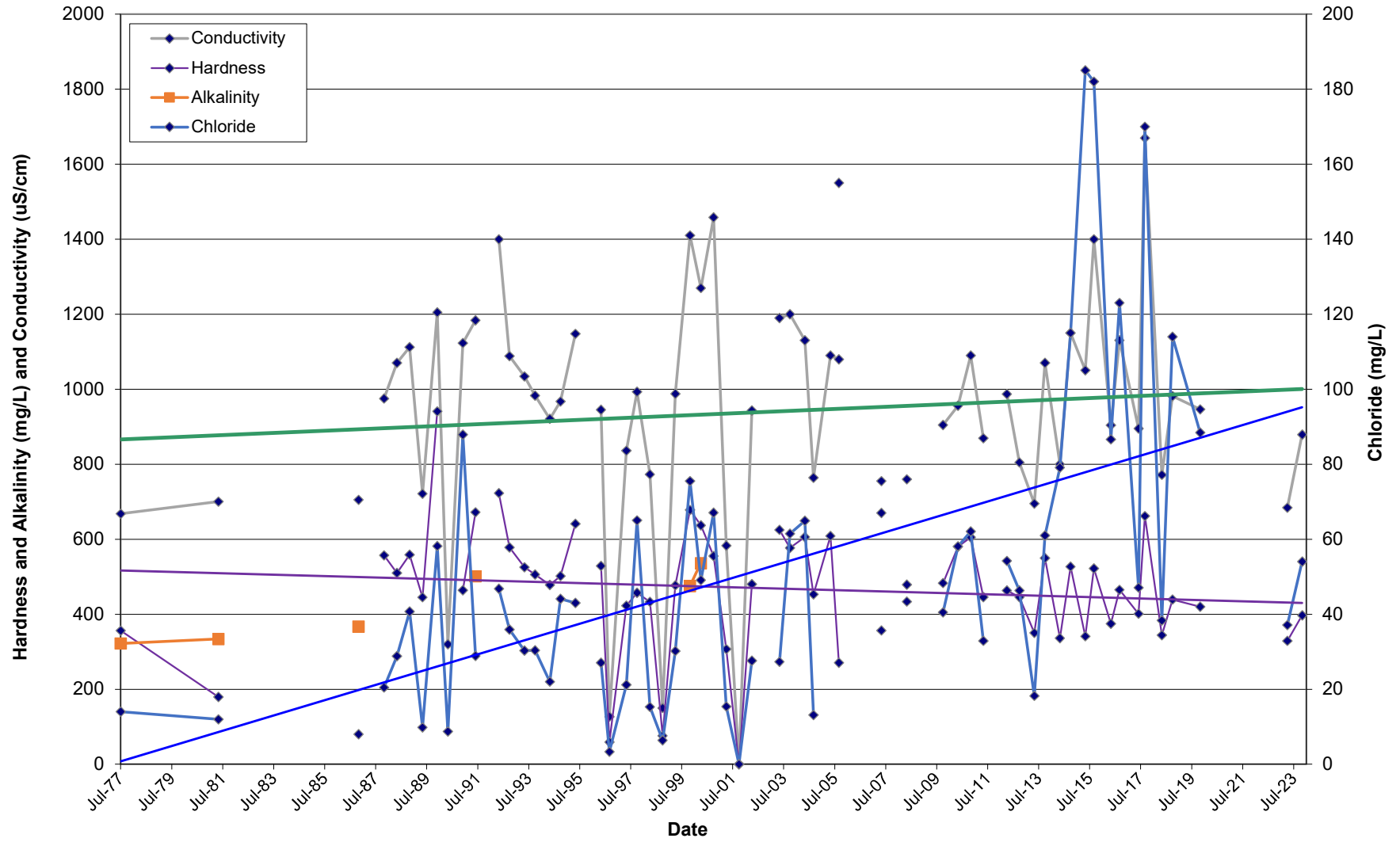

**Historic Surface Water Quality Data
Sample SP2A-85**

DATE	Temp (°C) (field)	Ca	Mg	Na	K	Alk. as CaCO3	SO4	Cl	Hardness as CaCO3	pH	Conduct.	Fe	Phenols	NH ₃ as N	Unionized Ammonia as NH ₃ ****	TKN as N	Organic Nitrogen	NO ₂ as N	NO ₃ as N	DOC	Mn	Total P	As
PWQO									6.5 - 8.5		0.3		1		0.02							0.03	0.005
19-Nov-87		105.5	28.6				9.28	382	7.78	715		<	1	0.003					<1.0	4.5		0.042	
19-May-88		85.5	20.21				36.1	297	8.19	720		<	1	0.048					<1.0	5.9		0.069	
2-Nov-88		93.8	23.4				10.8	331	7.6	685		<	1	0.006					<1.0	4.1		0.032	
24-May-89		110	25.9				23.6	382	8.09	769	0.28	<	1.5	0.172					0.5	4.4		0.072	
11-Dec-89		93.9	21.6				16.2	324	7.77	593			7	0.104					0.4			0.017	
16-May-90							11.9	7.67	402				5	0.007					0.5			0.178	
2-Dec-90		84.3	18.6				97.4	287	7.78	*3270		<	1	0.021					1.2			0.071	
3-Jun-91						DRY																	
19-Nov-91		98.50	25.10				15.80	350	8.00	697			1.5	0.007					0.1			0.041	
19-Nov-91 *		101	25.8				15.9	359	8.00	696				0.001					0.1			0.032	
19-May-92		104	28.7				11.6	378	7.96	705			5	0.066					0.4			0.056	
26-Oct-92		118	34				14.4	436	7.92	787			6.0						0.7			0.049	
25-May-93		78.5	20.3				6.8	280	8.04	540			4.5	0.087					0.3			0.134	
25-May-93 *		79.3	20.6				6.9	283	8.04	842			4.0	0.078					0.4			0.142	
18-Oct-93		93	19.2				7.4	312	7.9	585			5	0.044					0.4			0.102	
3-May-94		101	27.7	8.2	1.5		7.7	368	8.21	671			1.7	0.034				<0.01	0.2			0.029	
3-May-94 *		100	27.6	8.0	1.5		7.7	364	8.14	668			1.5	0.026				<0.01	0.2			0.027	
21-Oct-94		80.7	32				12.2	334	8.12	728		<	1	0.017				0.01	0.1			0.022	
29-May-95		96.8	36.2				7.3	391	8.06	702			6.7	0.07				<0.01	0.2			0.04	
11-Oct-95 DRY																							
9-May-96		104	26.7				5.7	370	7.91	621		<	1	<	0.01			0.16	<0.1	<1			
25-Sep-96		20	2.8				3.1	62	7.76	128		<	1	0.05				<0.1	<0.1			0.05	
8-May-97		101	26.2				94	360	7.94	666		<	1	0.02				<0.1	<0.1			0.02	
23-Oct-97		74	15.8				11.3	250	7.85	472		<	1	0.02				<0.1	<0.1			0.05	
23-Oct-97 *		56.6	15.7				11.2	206	7.82	473		<	1	0.02				<0.1	<0.1			0.05	
16-Apr-98		32.2	9.4				3.1	119	8.09	118			2	0.16				<0.1	0.3			0.14	
21-Oct-98		40.4	6.4				3.5	127	7.61	239		<	1	<	0.01			<0.1				0.15	
21-Apr-99		87	19.8				15.1	299	8.29	644		<	1	<	0.01			<0.1	<0.1			0.04	
11-Nov-99		97.5	18.8	14.4	2.2	250	21.4	36.2	7.89	612	0.05	<	1	<	0.01	0.32	0.31	<0.1	0.3		0.01	0.05	
13-Apr-00		71.8	23			258	9.3	15.4	7.95	555	0.03	<	1	<	0.01	0.32	0.31	<0.1	0.7	7	0.012	0.02	
17-Oct-00		102	32.6				19.8	389	7.3	721		<	1	0.02		0.55	0.53	<0.1	<0.1	17		0.07	
24-Apr-01		66.8	25.4				17.1	14.5	271	8.12	573		<	1	0.03		0.5	0.47	<0.1	1.3			
3-Oct-01 DRY																							
18-Apr-02		82.5	27.8	9.5	2		15.3	321	7.64	576			2	0.09		0.62	0.53	<0.1	<0.1				
24-Oct-02 DRY																							
22-May-03		119	26.5				54.4	406	7.83	749		<	1	<	0.01	0.78	0.77	<0.1	8.6			0.08	
30-Oct-03		127	28.8				25	436	8.11	796		<	1	0.03		0.41	0.38	<0.1	<0.1			0.03	
20-May-04		116	27.6				24.5	404	7.96	627		<	1	0.09		0.76	0.67	<0.1	0.2			0.11	0.001
30-Sep-04 DRY																							
5-May-05	12.9	120	31.5					430	8.13	724		<	1	0.01	0.00067	0.39	0.38	<0.1	0.2			0.09	<0.001
29-Sep-05	11.9	34.2	7.93				107	118	7.68	554		<	1	0.01	0.00050	0.52	0.51	<0.1	0.2			0.12	<0.001
29-Sep-05 *		34	7.85				106	117	7.69	554		<	1	0.02		0.47	0.45	<0.1	0.2			0.12	<0.001
4-May-06 DRY																							
28-Sep-06 DRY																							
10-May-07	13	81.3	21.4				66.9	291	7.9	688		<	1	0.25	0.00690	0.92	0.67	0.2	2.7			0.11	0.001
10-May-07 *		83	21.8				66.8	297	7.98	735		<	1	0.25		0.87	0.62	0.2	2.7			0.11	0.0012
4-Oct-07 DRY																							
15-May-08	8.7	114	29.6				43.6	407	7.43	828		<	1	0.03	0.00048	0.42	0.39	<0.1	0.7			0.03	0.0006
2-Oct-08 DRY																							
21-May-09		101	24.3				22	352	7.55	704		<	1	0.02		0.33	0.31	<0.1	0.2			0.04	<0.0005
15-Oct-09	5.1	114	24.9				47.9	388	7.59	784		<	1	<	0.01	<	0.00109	0.35	0.34	<0.1	0.1	0.04	0.0007
6-May-10	10.4	86.5	16.8				49.6	285	7.92	646		<	1	0.05	0.00222	0.59	0.54	<0.1	0.1			0.07	0.0005
11-Nov-10	4.0	144	37				24.8	512	7.86	878		<	1	<	0.01	<	0.00022	0.21	0.2	<0.1	0.1	0.03	<0.0005
5-May-11	6.2	111	29.5				16.5	399	7.81	774		<	1	0.01	0.00050	0.18	0.17	<0.1	0.3			0.02	0.0006
29-Sep-11 DRY																							
19-Apr-12		111	27.7				12.8	391	8.34	682		<	1	<	0.01	0.33	0.33	<0.1	<0.1			0.05	0.0011
4-Oct-12 DRY																							
2-May-13	12.2	93.9	21.5				7.9	323	8.21	605		<	1	<	0.01	<	0.02	0.28	0.28	<0.1	0.2	0.02	0.0004
3-Oct-13 DRY																							
7-May-14	6.9	110	26.2				11.5	383	8.17	714		<	1	<	0.01	<	0.02	0.18	0.18	<0.1	0.3	0.03	0.0005
2-Oct-14	13.3	136	28.3				4.3	457	7.99	715		<	1	0.02	<	0.02	0.28	0.26	<0.1	0.1	0.06	0.0004	
6-May-15	6.5	133	29.6				10.3	455	8.15	743		<	1	<	0.01	<	0.02	0.3	0.3	<0.1	0.2	0.03	0.0003
22-Sep-15	9.8	82.8	14.3				5.9	266	8.04	527		<	1	<	0.01	<	0.02	0.4	0.4	<0.1	<0.1	0.09	0.0005
4-May-16	9.4	122	34.7				11.5	448	8.14	797		<	1	<	0.01	<	0.02	0.17	0.17	<0.1	0.1	<0.01	<0.0001
28-Sep-16	12.2	36																					

**Historic Surface Water Quality Data
Sample SP2A-85**

DATE	Temp (°C) (field)	Ca	Mg	Na	K	Alk. as CaCO3	SO4	Cl	Hardness as CaCO3	pH	Conduct.	Fe	Phenols	NH ₃ as N	Unionized Ammonia as NH ₃ ****	TKN as N	Organic Nitrogen	NO ₂ as N	NO ₃ as N	DOC	Mn	Total P	As			
PWQO									6.5 - 8.5			0.3	1		0.02							0.03	0.005			
5-Jun-17	13.3	98.3	22.6					8.7	338	8.11	675		1	0.07	<	0.02	0.4	0.33	0.16	3.99			0.03	0.0005		
27-Sep-17	DRY																									
15-May-18	13.9	30.3	6.33					16.0	102	7.94	220		<	1	0.12	<	0.02	0.6	0.48	<0.05	0.64			0.11	0.0006	
15-May-18	*	31.3	6.59					16.0	105	7.96	220		<	1	0.10		0.6	0.5	<0.05	0.64				0.12	0.0007	
3-Oct-18	11.0	47.3	6.83					6.0	146	8.04	309		<	2	0.02	<	0.02	0.3	0.28	<0.05	0.58			0.11	0.0004	
30-May-19	12.0	96.6	22.3	14.9		287	6.0	41.2	333	8.2	687	0.077	<	0.002	0.09		0.4	0.31	< 0.05	2.0			0.04	0.0005		
25-Nov-19	3.5	95.2	20.8			268	8.0	27.7	323	8.01	639	0.207	<	0.002	0.07		0.6	0.53	< 0.05	5.0			0.05	0.0003		
20-May-20																										
6-Nov-20		107	20.2	10.4	1.3	317	7.0	26.7	351	8.06	688	0.067	<	0.002	0.01		0.008	0.3		< 0.05	1.1			0.04	0.0003	
8-Apr-21																										
7-Oct-21	12.0	101	21.8	6.1	1.8	357	4.0	20.5	341	7.91	694	0.112	<	0.002	0.07		0.000	0.7	0.63	< 0.05	0.31			0.09	0.0008	
11-May-22																										
15-Sep-22																										
11-Apr-23	5.0	96.7	22.9	16.6	1.8	305	7.0	32.4	336	8.2	678	0.366	<	0.001	0.02		0.000	0.2		< 0.05	1.2	3.3		0.08	0.0005	
2-Nov-23	7.0	117	28.5	16.8		391	7.0	35.2	410	8.1	789	0.144	<	0.001	<0.05		0.0004	0.4		<0.05	2.6	5.7		0.03	0.0004	
Average	10.0	88.9	22.3	10.0	1.8	254.00	15.9	23.86	314	7.92	661	0.12		1.7	0.044	0.01181	0.44	0.40	0.1	0.8	7.2	0.01	0.068	0.001		
Maximum	13.9	144	37	14.4	2.2	258	21.4	107	512	8.34	3270	0.28		7	0.25	0.02000	0.92	0.77	0.2	8.6	17	0.012	0.178	0.0012		
Minimum	4	20	2.8	8	1.5	250	9.3	3.1	62	7.3	118	0.03		1	0.001	0.00022	0.17	0.17	0.01	0.1	4.1	0.01	0.017	0.0003		
Count	18	56	56	4	4	3	3	56	56	57	57	3		56	56	18	31	31	43	56	7	2	54	24		

*denotes duplicate sample

All results expressed as mg/L except the following parameters:

pH as log [H⁺]

phenols as ppb

conductivity as µS/cm

****Fraction (f) of NH₃ where $f = 1/(10^{pH-pKa} + 1)$; $pKa = 0.09018 + 2729.92/T$; $T = °C + 273.16$

Surface Water Sample SP2A-85

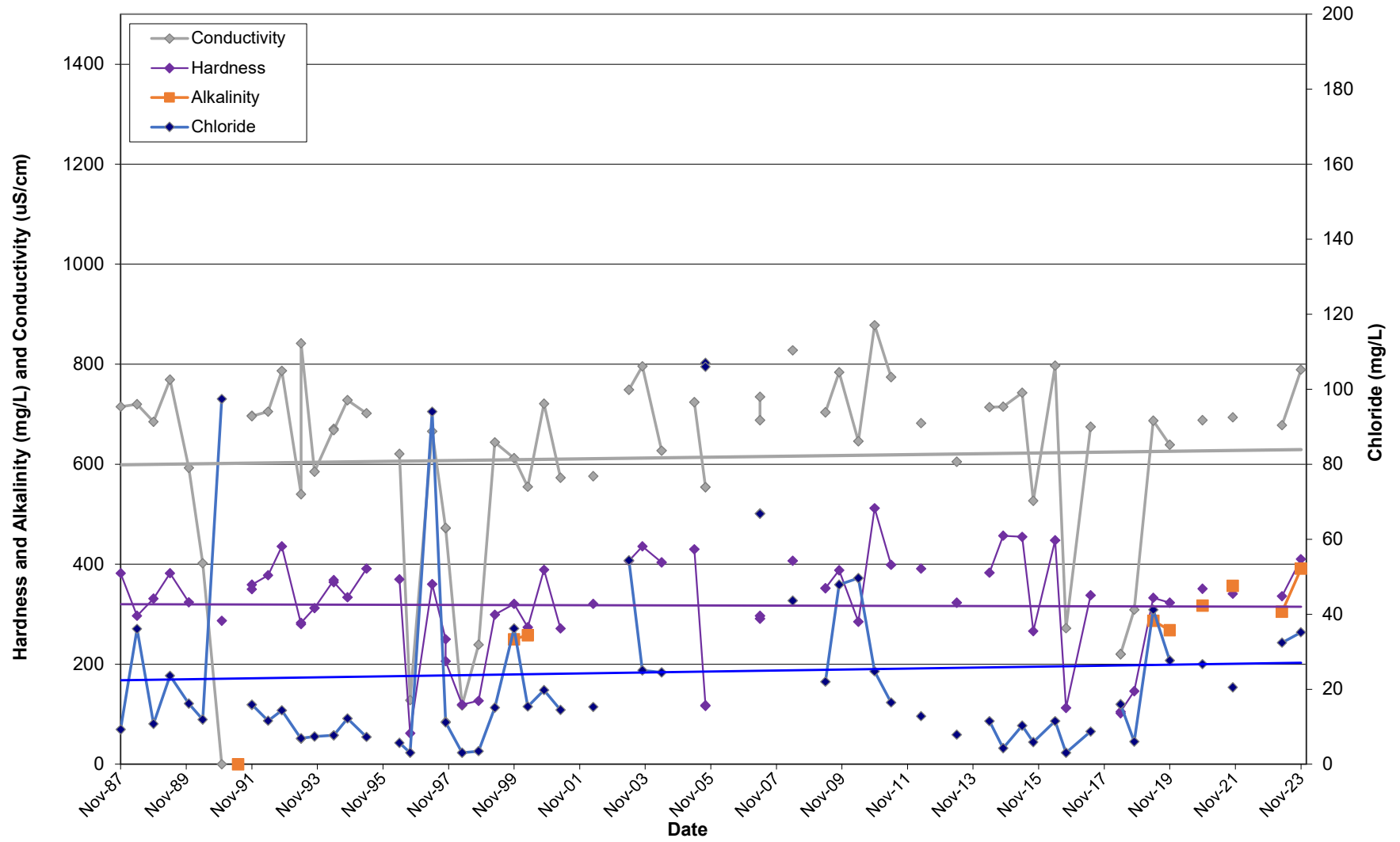

Historic Surface Water Quality Data
Sample SP3-85

DATE	Temp (°C) (field)	Ca	Mg	Na	K	Alk. as CaCO3	SO4	Cl	Hardness as CaCO3	pH	Conduct.	Fe	Phenols	NH3 as N	Unionized Ammonia as NH3 ****	TKN as N	Organic Nitrogen	NO2 as N	NO3 as N	DOC	Mn	Total P	As	0-P04
PWQO										6.5 - 8.5		0.3	1		0.02							0.03	0.005	
9-Jul-86		43.5	25.4	2.3	0.7	213	10	4	213	8.42	429		2	0.035		0.28		0.01	0.3	3.7		0.016		
13-Nov-86		61	25.6	2	1	240	11.5	4	258	8.35	451	0.001	< 0.01	0.005		0.27		0.01	0.7	3.2		0.007		
5-May-87		53.5	25.2					5.5	238	8.32	469	0.011	< 0.01	0.03		0.29		0.01	1	4.4				
19-Nov-87		59.2	25.79					5.54	254	8.22	416	0.008	< 0.01	0.047					0.2	3.9				
19-May-88		49.1	24.12					4.4	222	8.37	432	0.011	< 0.01	0.039					0.4	3.9				
2-Nov-88		51.7	22.52					5.58	222	8.1	448	0.006	< 0.01	0.011					0.4	5				
24-May-89		52.9	24.3					4.9	232	8.34	442	0.012		0.039					0.5	4				
11-Dec-89		57.2	24.3					6.1	243	8.18	451	0.005	< 1	0.02					0.7					
16-May-90								5.5		8.33	437		6.5	0.022					0.5			0.013		
4-Dec-90								9	218	8.24	435		< 1	0.008					0.5			0.009		
3-Jun-91		51.8	24.8					4.9	232	8.42	427		< 1	0.036					0.4			0.018		
19-Nov-91		53.3	25.5					6.2	238	8.33	452		1.0	0.026					0.4			0.006		
19-May-92		58.2	27.4					6	258	8.30	446		3.0	0.024					0.4			0.016		
26-Oct-92		65.6	29.0					6.5	283	8.22	469		2.0	0.122					0.5			0.010		
25-May-93		55.7	24.1					5.5	239	8.31	438		12.0	0.029					0.7			0.019		
18-Oct-93		60.1	25.8					7.2	257	8.18	459		1.0	0.006					0.5			0.019		
3-May-94		52.1	22.4	3.2	0.8			11.8	223	8.40	417		7.0	0.023			0.34	<0.01	0.5			0.011		
21-Oct-94		56.7	27.1					6.1	253	8.44	447		3.9	0.030			0.31	0.02	0.3			0.010		
29-May-95		61.5	27.4					5.3	267	8.36	456		6.6	0.08			0.46	0.02	0.2			0.05		
11-Oct-95		58.4	28.2					6.3	262	8.34	447		< 1	0.13			0.36	0.01	0.4			0.02		
11-Oct-95	*	58	28					6.6	260	8.33	451		1.7	0.14			0.34	0.01	0.4			0.02		
9-May-96		58.7	25.2					5.6	250	8	419		< 0.01	< 0.05			<0.1	<0.1	0.6			0.02		
25-Sep-96		52.8	27.2					6.3	244	8.19	443		< 1	0.06			0.45	<0.1	0.3			<0.01		
25-Sep-96	*	53.7	27.4					6.3	247	8.22	442		< 1	0.04			0.33	<0.1	0.3					
8-May-97		53.7	22.9					5.3	228	7.92	425		< 1	0.02			0.31	<0.1	0.4			0.01		
23-Oct-97		42.1	30.2					7.1	229	8.26	447		< 1	0.03			0.27	<0.1	0.3			<0.025		
16-Apr-98		58.9	25.1					6.2	250	8.33			< 1	0.01			0.13	<0.1	0.5			0.02		
21-Oct-98		55.9	27.1					6.4	251	8.08	440		< 1	< 0.01			0.26	<0.1	0.4			<0.01		
21-Apr-99		52.9	22.9					6.7	226	8.53	441		< 1	< 0.01			0.25	<0.1	0.5			0.02		
11-Nov-99		60.6	26	3.9	1.1	213	17.2	7.5	258	8.19	446	0.03	< 1	< 0.01			0.17	<0.1	0.4		<0.005			
13-Apr-00		52.2	29.9			222	11.5	7.4	253	8.37	453	0.02	< 1	< 0.01			0.22	0.21	<0.1	0.9	3	<0.005	<0.01	
17-Oct-00		62.6	27.4					7.4	269	8.14	463		< 1	0.01			0.35	0.34	<0.1	1.2		0.01		
24-Apr-01		47.1	21				9	5.6	204	8.15	416		< 1	< 0.01			0.4	0.39	<0.1	0.8				
3-Oct-01		57.6	26.8	4.1	1.2			6.7	254	8.26	435		< 1	< 0.01			0.4	0.39	<0.1	0.6				
18-Apr-02		51.5	22.2	3.6	1.0			6.0	220	7.68	399		< 1	< 0.01			0.29	0.28	<0.1	0.7				
24-Oct-02		64.6	30.8					6.3	288	8.27	455		< 1	0.04			0.24	0.2	<0.1	0.4			0.01	
22-May-03		60.2	2.58					6.4	161	8.24	423		< 1	< 0.01			0.36	0.35	<0.1	0.5		<0.01		
30-Oct-03		53.7	22.8					7.2	228	8.28	457		< 1	0.03			0.3	0.27	<0.1	0.5		<0.01		
30-Oct-03	*	53.8	22.8					7.2	228	8.25	459		< 1	0.02			0.28	0.26	<0.1	0.5		<0.01		
20-May-04		56.8	23.4					5.9	238	8.25	434		< 1	0.03			0.3	0.27	<0.1	0.5		<0.01	0.001	<0.01
30-Sep-04		48	25.7					6.4	226	8.36	420		< 1	0.03			0.22	0.19	<0.1	0.3		<0.01	0.001	<0.01
5-May-05	10	59.1	25.6						253	8.3	417		< 1	< 0.01	< 0.00103		0.2	0.19	<0.1	0.5		0.01	<0.001	<0.01
29-Sep-05	15.4	49.6	24.7					5.7	225	8.23	422		< 1	0.02	0.00298		0.37	0.35	<0.1	0.3		0.02	<0.001	<0.01
4-May-06	17	58.8	25.2					6.1	251	8.28	432		< 1	< 0.01	< 0.00135		0.41	0.4	<0.1	0.6		0.01	0.001	
4-May-06	*	57.1	24.5					6.1	244	8.28	432		< 1	< 0.01			0.39	0.38	<0.1	0.6		0.01	<0.001	
28-Sep-06	14.1	50.5	26.7					5.9	236	8.26	415		< 1	< 0.01	< 0.00294		0.19	0.18	<0.1	0.3		<0.01	0.0003	
28-Sep-06	*	50.6	26.7					5.8	236	8.26	417		< 1	< 0.01			0.19	0.18	<0.1	0.3		<0.01	0.0003	
10-May-07	15.7	52.4	23.1					5.6	226	8.23	447		< 1	< 0.01	< 0.00053		0.21	0.2	<0.1	0.6		<0.01	<0.0005	
4-Oct-07	17.4	50.1	27.6					7	239	8.01	422		< 1	< 0.01	< 0.00353		0.23	0.22	<0.1	0.2		<0.01	<0.0005	
4-Oct-07	*	49.8	27.5					6.9	238	8.09	398		< 1	< 0.01			0.24	0.23	<0.1	0.2		<0.01	<0.0005	
15-May-08	13.4	62.1	26.6					5.7	265	7.81	422		< 1	< 0.01	< 0.00106		0.26	0.25	<0.1	0.5		<0.01	<0.0005	
15-May-08	*	62.4	26.7					5.8	266	7.93	425		< 1	< 0.01			0.27	0.26	<0.1	0.5		<0.01	<0.0005	
2-Oct-08	13.2	50.1	24.3					6	225	8.39	387		< 1	< 0.01	< 0.00055		0.23	0.23	<0.1	0.3		<0.01	<0.0005	
21-May-09	17.9	56.7	24.9					5.2	244	7.73	452		< 1	< 0.01	< 0.00257		0.21	0.2	<0.1	0.3		<0.01	<0.0005	
15-Oct-09	7.9	57.7	27.1					6.1	256	8.01	539		< 1	< 0.01	< 0.00342		0.18	0.17	<0.1	0.3		<0.01	<0.0005	
6-May-10	15.9	56.8	25.8					5.8	248	8.14	444		< 1	< 0.01	< 0.00082		0.23	0.22	<0.1	0.4		0.02	<0.0005	
6-May-10	*	56.6	25.7					5.7	247	8.17	444		< 1	0.02			0.19	0.17	<0.1	0.4		0.02	<0.0005	
11-Nov-10	6.2	64.7	28.4					3.2	279	8	472		< 1	< 0.01	< 0.00032		0.11	0.11	<0.1	0.5		<0.01	<0.0005	
5-May-11	12.7	49.4	21.2					5.4	211	8.09	443		< 1	< 0.01	< 0.00152		0.14	<0.14	<0.1	0.4		<0.01	0.0003	
29-Sep-11	19.1	58.1	30.7					5.4	271	8.13	439		< 1	0.02	0.00166		0.27	0.25	<0.1	0.3		0.04	0.0005	
29-Sep-11	*	56.7	30.1					5.3	265	8.15	435		< 1	0.01			0.25	0.24	<0.1	0.2		0.04	0.0008	
19-Apr-12	12.0	52.5	24.5					5.7	232	8.37	454		< 1	< 0.01	< 0.02		0.24	0.24	<0.1	0.6		0.01	0.0003	
3-Oct-12	15.4	46.8	26.6					6.0	226	8.32	418		< 1	< 0.01	< 0.02		0.16	0.16	<0.1	0.3		<0.01	0.0003	
2-May-13	17.2	52.6	21.4					5.6	220	8.31	397		< 1	< 0.01	< 0.02		0.27	0.27	<0.1	0.5		<0.01	<0.0001	
3-Oct-13	18.3	51.3	27.1					5.7	240	8.30	372		< 1	< 0.01	< 0.02		0.29	0.29	<0.1	0.3		<0.01	0.0003	
3-Oct-13	*	49.5	26.6					5.7	233	8.32	378		< 1	< 0.01			0.26	0.26	<0.1	0.3				

**Historic Surface Water Quality Data
Sample SP3-85**

DATE	Temp (°C) (field)	Ca	Mg	Na	K	Alk. as CaCO3	SO4	Cl	Hardness as CaCO3	pH	Conduct.	Fe	Phenols	NH ₃ as N	Unionized Ammonia as NH ₃ ****	TKN as N	Organic Nitrogen	NO ₂ as N	NO ₃ as N	DOC	Mn	Total P	As	0-PO4	
PWQO										6.5 - 8.5		0.3	1		0.02							0.03	0.005		
6-May-15	15.4	58.6	25.3					5.6	250	8.27	417		<	0.01	<	0.02	0.4	0.4	<0.1	0.5			0.01	0.0002	
22-Sep-15	19	56.6	27.8					5.9	256	8.24	436		<	0.01	<	0.02	0.2	0.2	<0.1	0.3			0.02	0.0003	
22-Sep-15	*	59.8	29.4					5.9	270	8.26	427		<	0.01	<	0.01	0.3	0.3	<0.1	0.3			0.01	0.0003	
4-May-16	12.9	54.3	27.6					5.4	249	8.25	437		<	0.01	<	0.02	0.17	0.17	<0.1	0.6			<0.01	<0.0001	
28-Sep-16	17.3	49.0	27.5					4.9	236	8.31	417		<	0.01	<	0.02	0.21	0.21	<0.1	0.3			<0.01	0.0002	
5-Jun-17	17.9	55.6	24.6					4.5	240	8.33	442		<	0.03	<	0.02	0.3	0.27	<0.05	0.37			0.01	0.0002	
27-Sep-17	22.0	54.7	27.9					5.3	251	8.31	447		<	0.01	<	0.02	0.23	0.22	<0.05	0.33			<0.01	0.0003	
15-May-18	18.0	51.2	24.0					5.7	227	8.32	419		<	0.06	<	0.02	0.3	0.24	<0.05	0.62			0.01	0.0005	
3-Oct-18	11.6	56.2	26.8					5.9	251	8.30	421		2	0.03	<	0.02	0.2	0.17	<0.05	0.35			0.03	0.0003	
30-May-19	13.0	59.4	23.3	3.3		222	3.0	6.2	244	8.36	446	0.14	<	0.002	0.06	<	0.02	0.2	0.14	<0.05	0.67			0.03	0.0002
25-Nov-19	3.00	56.5	23.8			215	8.0	9.1	239	8.31	444	0.03	<	0.002	0.06	<	0.02	0.3	0.24	<0.05	0.76			<0.01	0.0002
20-May-20		63.9	26.4	4.4	1.0	220	4.0	6.2	268	8.36	448	0.16	<	0.002	0.02		0.016	0.5	0.48	<0.05	0.78			0.01	0.0002
6-Nov-20		57.9	23.1	3.8	0.9	228	7.0	8.0	240	8.26	457	0.04	<	0.002	<	0.01	0.013	0.2	0.19	<0.05	0.57			<0.01	0.0002
8-Apr-21	10	53.3	23.7	3.8	0.9	212	5.0	6.8	231	8.26	428	0.03	<	0.002	0.01		0.000	0.3	0.29	<0.05	0.71	4.8		<0.01	0.0002
7-Oct-21	11	55	24.6	3.6	1.1	277	4.0	7.0	239	8.17	427	0.02	<	0.002	0.03		0.000	0.4	0.37	<0.05	0.39			0.01	0.0003
11-May-22	7	58.5	25.7	3.8	0.9	252	6.0	8.8	252	8.35	472	0.08	<	0.001	0.01		0.000	0.2		<0.05	0.87	4.1		0.01	0.0003
15-Sep-22	20	47	28.8	3.9	1	230	5.0	6.1	236	8.18	420	0.10	<	0.001	0.01		0.000	0.4		<0.05	0.15	3.1		0.03	0.0003
11-Apr-23	7	46.4	19.4	3.3	0.9	189	4.0	6.1	196	8.24	387	0.07	<	0.001	0.01		0.000	0.2		<0.05	0.63	3.3		0.03	0.0002
2-Nov-23	7	57.3	27.5	4.1		243	6.0	8.5	256	8.17	468	0.04	<	0.001	<	0.05	5.23E-10	0.3		<0.05	0.67	5.9		<0.01	0.0002
Average	15.0	54.9	25.43	3.2	1.0	222	11.8	5.97	242	8.23	457	0.12		1.4	0.024	0.01087	0.27	0.25	0.01	0.5	3.9			0.017	0.000
Maximum	22	65.6	30.8	4.1	1.2	240	17.2	11.8	288.088	8.53	2150	0.03		12	0.14	0.02000	0.46	0.4	0.02	1.2	5			0.05	0.001
Minimum	6.2	42.1	2.58	2	0.7	213	9	3.2	161	7.68	372	0.001	0.01	0.005	0.00032	0.11	0.1	0.01	0.2	3			0.006	0.0002	
Count	28	76	76	6	6	4	5	76	76	77	77	9	77	77	28	64	46	64	77	8			66	38	

* denotes duplicate sample

All results expressed as mg/L, except the following parameters:

pH as -log [H⁺]

phenols as ppb

conductivity as µS/cm

****Fraction (f) of NH₃ where $f = 1/(10^{pH-pK_a} + 1)$; $pK_a = 0.09018 + 2729.92/T$; $T = °C + 273.16$

Surface Water Sample SP3-85

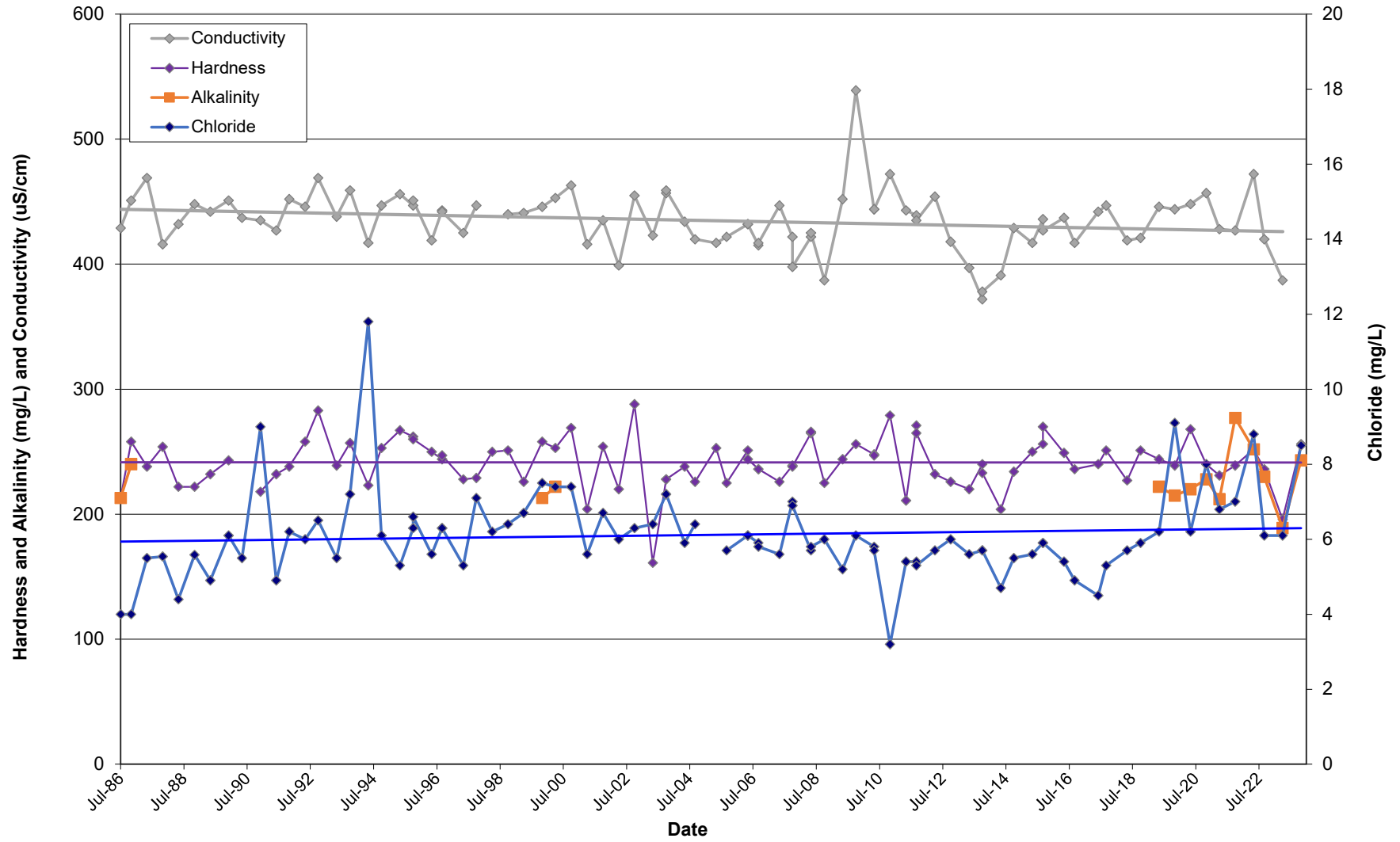

Historic Surface Water Quality Data
Sample SP4-85

DATE	Temp (°C) (field)	Ca	Mg	Na	K	Alk. as CaCO ₃	SO ₄	Cl	Hardness as CaCO ₃	pH	Conduct.	Fe	Phenols		NH ₃ as N	Unionized Ammonia as NH ₃ ****	TKN as N	Organic Nitrogen	NO ₂ as N	NO ₃ as N	DOC	Mn	Total P	As	0-PO ₄
PWQO									6.5 - 8.5			0.3	1		0.02							0.03	0.005		
9-Jul-86		43.5	25.4					4	213	8.42	429		2		0.035		0.28		0.01	0.3			0.03	0.005	
13-Nov-86		61	25.6		<0.001			4	258	8.35	451	<	1		0.005		0.27		0.01	0.7			0.03	0.005	
5-May-87		53.5	25.2		0.011			5.5	238	8.32	469	<	1		0.03		0.29		0.01	1			0.03	0.005	
19-Nov-87		59.2	25.79		0.008			5.54	254	8.22	416	<	1		0.047					0.2			0.03	0.005	
19-May-88		49.1	24.12		0.012			4.4	222	8.37	432	<	1		0.039					0.4			0.03	0.005	
2-Nov-88		51.7	22.52		0.006			5.58	222	8.1	448	<	1		0.011					0.4			0.03	0.005	
24-May-89		52.9	24.3		0.013			4.9	232	8.34	442	0.13	1		0.039					0.5			0.03	0.005	
11-Dec-89		65.2	25.6		0.004			6.3	268	8.11	451		1		0.025					0.8			0.03	0.005	
16-May-90								5.6		8.33	437	<	1		0.018								0.03	0.005	
4-Dec-90		52.6	22.3					8.7	223	8.24	454	<	1		0.019								0.03	0.005	
3-Jun-91		51.3	24.5					5.1	229	8.43	427	<	1		0.031								0.03	0.005	
19-Nov-91		53.9	25.9					6.4	241	8.33	460		1.5		0.014								0.03	0.005	
19-May-92		57.5	27.8					6.2	258	8.32	442		4.0		0.018								0.03	0.005	
26-Oct-92		65.4	29.1					6.4	284	8.18	475		2.0		0.008								0.03	0.005	
25-May-93		56.1	24.8					5.6	242	8.32	445		2		0.03								0.03	0.005	
18-Oct-93		65.9	26.9					8.8	276	8.13	506	<	1		0.005								0.03	0.005	
18-Oct-93 *		63.9	26.4					7.7	269	8.09	503	<	1		1								0.03	0.005	
3-May-94		54.2	23.7	3.1	1.0			5.2	233	8.42	419		5.5		0.023		0.34		<0.01	0.4			0.03	0.005	
21-Oct-94		57.1	27.3					6.1	255	8.42	449	<	1		0.032		0.3		0.02	0.3			0.03	0.005	
29-May-95		61.4	27.2					5.8	266	8.35	459		5.9		0.07		0.46		0.02	0.3			0.03	0.005	
11-Oct-95		58.4	28.6					6.6	264	8.31	454		1.7		0.11		0.34		0.01	0.4			0.03	0.005	
9-May-96		60.7	26.1					5.6	259	8.14	421		1	<	0.01		<0.05		<-1	0.5			0.03	0.005	
9-May-96 *		61.3	26.4					5.7	262	6.69	421	<	1	<	0.01		<0.05		<-1	0.6			0.03	0.005	
25-Sep-96		54.8	27.5					6.4	250	8.12	447	<	1		0.02		0.38		<-1	0.3			0.03	0.005	
8-May-97		54.2	22.8					5.3	229	7.99	428	<	1		0.03		0.28		<-1	0.4			0.03	0.005	
8-May-97 *		52.5	22.9					2	225	8.14	426	<	1		0.03		0.31		<-1	0.2			0.03	0.005	
23-Oct-97		44.2	30.6					7.1	236	8.25	449	<	1		0.03		0.22		<-1	0.3			0.03	0.005	
16-Apr-98		56.8	25.1					6.0	245	8.34	431	<	1	<	0.01		0.14		<-1	0.5			0.03	0.005	
21-Oct-98		58.6	30.8					6.4	273	8.03	444	<	1	<	0.01		0.26		<-1	0.4			0.03	0.005	
21-Apr-99		47.9	22.0					7	210	8.7	437	<	1	<	0.01		0.31		<-1	0.4			0.03	0.005	
11-Nov-99		60.3	25.9	4	1.1	219	18	7.6	257	8.23	447	0.02	<	1	<	0.01		0.22		<-1	0.4			0.03	0.005
13-Apr-00		64.1	30.6			221	10.8	7.1	286	8.3	449	0.04	<	1	<	0.01		0.19	0.18	<-1	0.9	3	0.006	0.03	0.005
17-Oct-00		62.1	27.6					7.4	269	8.25	465	<	1	<	0.01		0.33	0.32	<-1	11.7			0.03	0.005	
24-Apr-01		47.6	21.6				9.6	6	208	8.18	422	<	1	<	0.01		0.3	0.29	<-1	0.8			0.03	0.005	
3-Oct-01		56.7	26.4	3.6	1.1			7	250	8.28	440	<	1	<	0.01		0.42	0.41	<-1	0.6			0.03	0.005	
18-Apr-02		52.6	22.5	4.2	1.2			6.1	224	7.68	401	<	1	<	0.01		0.28	0.27	<-1	0.7			0.03	0.005	
24-Oct-02		65.4	30.5					6.3	289	8.26	456	<	1		0.05		0.24	0.19	<-1	0.5			0.03	0.005	
24-Oct-02 *		63.8	30.5					6.4	285	8.24	457	<	1		0.04		0.24	0.2	<-1	0.5			0.03	0.005	
22-May-03		60.5	25.9					6.7	258	8.27	422	<	1	<	0.01		0.35	0.34	<-1	0.5			0.03	0.005	
22-May-03 *		60.5	25.8					6.6	257	8.27	424	<	1	<	0.01		1.82	1.81	<-1	0.5			0.03	0.005	
30-Oct-03		56.2	24.9					7.4	243	8.28	458	<	1		0.02		0.28	0.26	<-1	0.5			0.03	0.005	
20-May-04		58	23.8					6.1	243	8.27	438	<	1		0.08		0.32	0.24	<-1	0.5			0.03	0.005	
30-Sep-04		49.5	26.2					6.4	232	8.34	424	<	1		0.03		0.24	0.21	<-1	0.4			0.03	0.005	
5-May-05	10.4	59	25.7					6	253	8.32	418	<	1	<	0.01	<	0.00130	0.19	0.18	<-1	0.5			0.03	0.005
29-Sep-05	15.2	48	24.3					6	220	8.26	427	<	1		0.02	0.00359	0.31	0.29	<-1	0.3			0.03	0.005	
4-May-06	17.2	57	24.7					6.2	244	8.3	432	<	1	<	0.01	<	0.00112	0.34	0.33	<-1	0.5			0.03	0.005
28-Sep-06	14.1	50.2	26.3					6	234	8.26	415	<	1	<	0.01	<	0.00294	0.24	0.23	<-1	0.3			0.03	0.005
10-May-07	15.7	55.2	24.3					5.6	238	8.29	425	<	1	<	0.01	<	0.00053	0.2	0.19	<-1	0.6			0.03	0.005
4-Oct-07	17.1	50.1	27.6					6.8	239	8.12	410	<	1	<	0.01	<	0.00407	0.25	0.24	<-1	0.2			0.03	0.005
15-May-08	13.7	62.1	26.4					5.8	264	7.63	429	<	1	<	0.01	<	0.00133	0.27	0.26	<-1	0.5			0.03	0.005
2-Oct-08	13.3	50.7	24.4					6.1	227	8.51	404	<	1	<	0.01	<	0.00044	0.23		<-1	0.4			0.03	0.005
2-Oct-08 *		50.4	24.4					6	226	8.56	409	<	1	<	0.01		0.22		<-1	0.3			0.03	0.005	
21-May-09	17.9	56.5	24.7					5.2	243	8.12	424	<	1	<	0.01		0.2	0.19	<-1	0.3			0.03	0.005	
15-Oct-09	7.8	58	27					6.1	256	7.92	436	<	1	<	0.01	<	0.00341	0.18	0.17	<-1	0.3			0.03	0.005
6-May-10	16.2	58.4	26.6					5.8	255	8.09	446	<	1		0.01	0.00022	0.2	0.19	<-1	0.4			0.03	0.005	
11-Nov-10	6.1	64.5	28.3					6.2	278	8.09	504	<	1	<	0.01	<	0.00032	0.13	0.12	<-1	0.5			0.03	0.005
11-Nov-10 *		63.7	28					6.2	274	8.15	502	<	1		0.01		0.14		<-1	0.5			0.03	0.005	
5-May-11	12.8	49.1	21.1					5.5	209	8.07	443	<	1	<	0.01	<	0.00125	0.14	<0.14	<-1	0.4			0.03	0.005
29-Sep-11	18.7	53.4	28.1					5.4	249	8.13	441	<	1		0.02	0.00130	0.22	0.20	<-1	0.3			0.03	0.005	
19-Apr-12	12.2	51.8	24.1					5.8	229	8.36	454	<	1	<	0.01	<	0.02	0.18	0.18	<-1	0.6			0.03	0.005
3-Oct-12	15.6	48.8	27.6					6.1	235	8.35	418	<	1	<	0.01	<	0.02	0.18	0.18	<-1	0.3			0.03	0.005
3-Oct-12 *		49.4	27.7					6.1	237	8.34	421	<	1	<	0.01		0.18	0.18	<-1	0.3			0.03	0.005	
2-May-13	17.8	52.4	21.3					5.7	218	8.32	391	<	1	<	0.01	<	0.02	0.26	0.26	<-1	0.5			0.03	0.005
3-Oct-13	18.1	52.1	27.5					5.7	243	8.30	374	<	1	<	0.01	<	0.02	0.29	0.29	<-1	0.3			0.03	0.005
7-May-14	11.7	46.4	20.5					4.8	201	8.32	389	<	1	<	0.01	<	0.02	0.13	0.13	<-1	0.5			0.03	0.005
2-Oct-14	16.2	58.0	24.2					6.0	244	8.29	425	<	1	<	0.01	<	0.02	0.32	0.32	<-1	0.4			0.03	0.005
2-Oct-14 *		56.7	23.7																						

**Historic Surface Water Quality Data
Sample SP4-85**

DATE	Temp (°C) (field)	Ca	Mg	Na	K	Alk. as CaCO3	SO4	Cl	Hardness as CaCO3	pH	Conduct.	Fe	Phenols		NH ₃ as N	Unionized Ammonia as NH ₃ ****	TKN as N	Organic Nitrogen	NO ₂ as N	NO ₃ as N	DOC	Mn	Total P	As	0-PO4		
PWQO									6.5 - 8.5			0.3	1			0.02							0.03	0.005			
6-May-15	*	60.8	26.0					5.7	259	8.29	423		<	1	<	0.01	0.3	0.3	<0.1	0.5			0.03	0.0002			
22-Sep-15		18.7	58.5	28.9				6.0	265	8.25	427		<	1	<	0.01	0.4	0.4	<0.1	0.3			0.01	0.0004			
4-May-16		13.0	58.4	29.5				4.7	267	8.26	434		<	1	<	0.01	0.20	0.20	<0.1	0.6			<0.01	<0.0001			
28-Sep-16		16.5	50.3	28.1				5.1	241	8.32	424		<	1	<	0.01	0.21	0.21	<0.1	0.3			<0.01	0.0003			
28-Sep-16	*	49.6	27.7					5.6	238	8.34	426		<	1	<	0.01	0.20	0.20	<0.1	0.6			<0.01	0.0002			
5-Jun-17		17.8	54.9	24.5				4.5	238	8.30	448			3	<	0.01	0.2	0.10	<0.05	0.40			0.01	0.0003			
27-Sep-17		21.6	54.9	28.0				5.3	252	8.29	454		<	1	0.02	<	0.02	0.56	0.54	<0.05	0.32			<0.01	0.0004		
27-Sep-17	*	54.8	28.0					5.3	252	8.30	447		<	1	0.01		0.18	0.17	<0.05	0.33			<0.01	0.0003			
15-May-18		16.9	54.9	25.4				5.9	242	8.33	425		<	1	0.06	<	0.02	0.3	0.24	<0.05	0.59			0.02	0.0006		
3-Oct-18		11.6	55.3	26.3				6.0	246	8.29	424		<	2	0.03	<	0.02	0.2	0.17	<0.05	0.35			0.03	0.0002		
3-Oct-18	*	54.3	26.4					6.0	244	8.33	421		<	2	0.03	<	0.02	0.2	0.17	<0.05	0.35			0.02	0.0002		
30-May-19		13	59.7	23.2	3.8		229	5.0	7.1	245	8.27	460	0.099	<	0.002	0.07	<	0.02	0.5	0.43	<	0.05	0.67		0.03	0.0002	
25-Nov-19		3.0	58.4	24.5			213	8.0	9.1	247	8.19	451	0.043	<	0.002	0.06	<	0.02	0.3	0.24	<	0.05	0.78		<	0.01	0.0002
20-May-20		66.3	26.6	5.5	1.2		225	6.0	7.7	275	8.23	474	0.073	<	0.002	0.01	0.012	0.3	0.29	<	0.05	0.7			0.01	0.0002	
6-Nov-20		67.0	25.3	6.1	1.5	241	10.0	10.4	271	8.3	488	0.053	<	0.002	<	0.01	0.014	0.2	0.19	<	0.05	0.64			<	0.01	0.0003
8-Apr-21	10	55.4	24.2	4.3	1.1	219	7.0	7.7	238	8.31	441	0.063	<	0.002	0.02	0.000	0.3	0.19	<	0.05	0.71	4.8			0.01	0.0002	
7-Oct-21	11	53.1	24.5	3.6	1.2	224	4.0	6.7	233	8.24	421	0.076	<	0.002	0.05	0.000	0.6	0.19	<	0.05	0.37				0.01	0.0003	
11-May-22	7	56.2	26.1	3.3	0.9	249	5.0	8.4	248	8.4	462	<	0.005	<	0.001	0.03	0.000	0.3	<	0.05	0.85	4.0			0.01	0.0003	
15-Sep-22	20	47.0	29	4.1	1	229	5.0	6.1	236	8.41	412	0.098	<	0.001	<	0.01	0.000	0.3	<	0.05	0.15	3.1			0.02	0.0003	
11-Apr-23	7	47.9	20.2	3.4	1	189	4.0	6.1	203	8.27	390	0.067	<	0.001	0.01	0.000	0.2	<	0.05	0.63	5.0			0.03	0.0002		
2-Nov-23	7	56.2	26.9	4.1		247	6.0	8.3	251	8.21	466	0.04	<	0.001	<	0.05	5.76E-10	0.3	<	0.05	0.67	6.2			0.01	0.0002	
Average	15.0	55.8	25.93	3.73	0.445	220.00	12.80	5.95	246	8.23	437	0.06	1.3		0.032	0.01118	0.29	0.28	0.01	0.6	3.9	0.006	0.197	0.000			
Maximum	21.6	65.9	30.8	4.2	1.2	221	18	8.8	288.855	8.70	506	0.13	5.9		1	0.02000	1.82	1.81	0.02	11.7	5	0.006	2.8	0.0011			
Minimum	6.1	43.5	20.5	3.1	0.004	219	9.6	2	201	6.69	374	0.02	1		0.005	0.00022	0.13	0.1	0.01	0.2	3	0.006	0.006	0.0001			
Count	28	78	78	4	11	2	3	78	78	79	79	3	79		79	27	65	45	65	79	8	1	72	38			

* denotes duplicate sample

All results expressed as mg/L except the following parameters:

pH as -log [H⁺]

phenols as ppb

conductivity as µS/cm

****Fraction (f) of NH₃ where $f = 1 / (10^{pH - pKa} + 1)$; $pKa = 0.09018 + 2729.92/T$; $T = °C + 273.16$

Surface Water Sample SP4-85

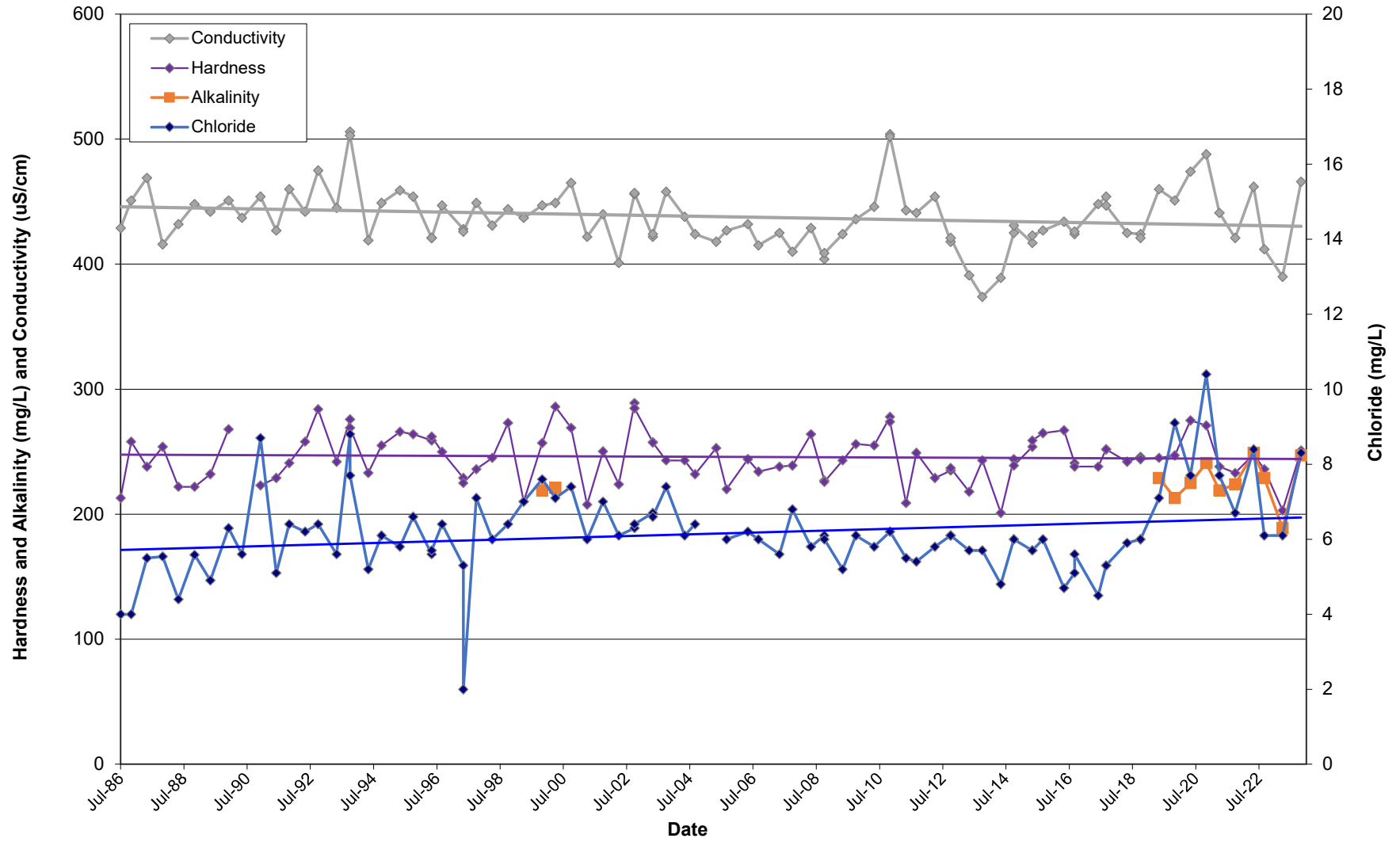

Historic Surface Water Quality Data
Sample SP5-88

DATE	Temp (°C) (field)	Ca	Mg	Na	K	Alk. as CaCO3	SO4	Cl	Hardness as CaCO3	pH	Conduct.	Fe 0.3	Phenols 1	NH3 as N	Unionized Ammonia as NH3 **** 0.02	TKN as N	Organic Nitrogen	NO2 as N	NO3 as N	DOC	Mn	Total P	As 0.005	0-PO4	
PWQO										6.5 - 8.5		0.3	1		0.02							0.03	0.005		
2-Nov-88		84	34		0.001			11	348	7.02	703		< 1	0.008		0.79				3.5	1.5				
24-May-89		90	36		0.004			12	373	7.83	722		< 1	0.174		1.5				2.9	1.5				
11-Dec-89		97	38.6		0.155			14.2	402	8.02	739		< 1	0.155						3					
16-May-90								11.60		7.89	689		1.5	0.009		0.500				3.1			0.004		
4-Dec-90		93.00	33.20					11.80	369	7.93	747		< 1	0.377						2.1			0.003		
3-Jun-91		84.4	34.9	11.3	4.1	264	42	12.3	355	7.94	695	0.03	< 1	0.228						2.2			0.005		
19-Nov-91		87.7	37.1					12.8	372	7.95	726		Broken	0.104						2.7			0.003		
19-May-92		165	180					12.3	1154	7.9	700		2.0	0.009						3.2			0.004		
26-Oct-92		87.5	43					14.0	396	7.84	742		6.5	0.061						2.7			0.009		
25-May-93		93.2	36.9					12.4	385	7.93	723		14	0.128						3.4			0.044		
18-Oct-93		97.4	36.8					15.7	395	7.81	747		1	0.005						2.1			0.126		
3-May-94		80.8	36.4	7.3	3.8			7.7	352	8.19	715		7.9	0.112		0.46		0.01		2.3	2.0		0.012		
21-Oct-94		74.4	40					13.6	351	8.04	727		< 1	0.105		0.39		0.03		2.1			0.010		
29-May-95		96.1	42.6					11.9	416	8.03	727		4.5	0.24		4.19		0.01		1.7			0.48		
11-Oct-95		77.5	40.8					13.1	362	7.91	730		1.2	0.13		0.34		0.02		2.1			0.02		
9-May-96		102	42.8					12.2	431	7.7	740		< 1	0.06		0.24		<0.1		2			<0.01		
25-Sep-96		76	82.4					11.3	529	7.66	614		< 1	0.05		0.47		<0.1		1.7			0.05		
8-May-97		98.6	37.1					11.9	399	7.46	761		< 1	0.42		0.65		<0.1		1.6			<0.01		
23-Oct-97		100	47.8					13	446	7.68	714		< 1	0.14		0.4		<0.1		2.2			0.004		
16-Apr-98		104	42.7					11.5	435	7.76	728		< 1	0.18		0.33		<0.1		2.3			0.02		
21-Oct-98		67.7	24.6					9.4	270	7.34	496		< 1	< 0.01		0.43		<0.1		1.6			0.08		
21-Apr-99		87.2	33.7					13	357	8.17	744		< 1	0.02		0.22		<0.1		2.4			0.02		
11-Nov-99		108	42.7	10.7	6.4	341	79.1	18.2	445	7.85	813	0.08	< 1	0.02		0.5		<0.1		2.2			0.013		
13-Apr-00		84.6	37.6			333	44.8	13.7	366	7.83	777	0.1	< 1	0.12		0.54	0.42	<0.1		2	3	0.032	0.02		
17-Oct-00		96.5	38.3					12.2	399	7.55	755		< 1	0.05		0.32	0.27	<0.1		2.8			0.03		
24-Apr-01		77.5	34.9				32	14.1	337	7.88	660		< 1	0.12		0.4	0.28	<0.1		1.6					
3-Oct-01		124	57.4	29.9	17.1			42.9	546	7.39	1233		49	6.04		11.1	5.06	<0.1		0.7					
18-Apr-02		94.4	39.8	9.4	5.2			13.7	400	7.52	751		1	0.41		1.03	0.62	<0.1		2.5					
24-Oct-02		106	41.7					13.3	436	8.13	728		< 1	0.08		0.21	0.13	<0.1		2.9			0.01		
22-May-03		99.6	5.61					16.2	272	8.04	747		< 1	0.26		0.69	0.43	<0.1		2.7			0.03		
30-Oct-03		104	39.9					22.9	424	8.09	813		< 1	0.14		0.48	0.34	0.2		2.5			0.01		
20-May-04		104	37.2					14.5	412	7.87	670		< 1	0.31		0.61	0.3	0.2		2.6			0.02	0.001	<0.01
20-May-04 *		103	36.9					14.6	408	7.87	663		< 1	0.31		0.67	0.36	0.2		2.6			0.02	0.001	<0.01
30-Sep-04		95.4	35.3					12.4	384	7.93	703		< 1	0.08		0.14	0.06	<0.1		3			<0.01	0.001	<0.01
30-Sep-04 *		92	34.1					12.7	370	7.9	695		< 1	0.06		0.18	0.12	<0.1		3			<0.01	0.001	<0.01
5-May-05	15	121	44.8					48.7	8.1	743		< 1	0.1	0.00500	0.49	0.39	<0.1		2.2			0.04	<0.001	<0.01	
29-Sep-05	12.1	92.4	35.8					12.7	378	7.94	728		< 1	0.03	0.00151	0.3	0.27	<0.1		2.6			0.01	<0.001	<0.01
4-May-06	15.9	108	38.7					16.4	430	8.01	761		< 1	0.23	0.00787	0.54	0.31	<0.1		2.5			<0.01	0.001	
28-Sep-06	10.8	105	37.6					16.7	417	7.84	741		< 1	0.09	0.00513	0.24	0.15	<0.1		2.5			<0.01	0.0003	
10-May-07	12.2	102	36.2					15.7	403	7.95	784		< 1	0.17	0.00353	0.24	0.07	<0.1		2.3			<0.01	0.0005	
4-Oct-07	11.2	109	37.2					17.7	426	7.75	804		< 1	0.01	0.00024	0.24	0.23	<0.1		2.2			<0.01	<0.0005	
15-May-08	15.5	116	41					16.5	458	7.5	692		< 1	0.18	0.00598	0.41	0.23	<0.1		2.1			<0.01	0.0007	
2-Oct-08	11.1	96	34					22.2	380	8.32	629		< 1	0.43	0.00520	0.6	0.17	<0.1		2.2			<0.01	<0.0005	
21-May-09	14.7	107	37.5					19.6	421	7.89	806		< 1	0.31		0.4	0.09	<0.1		2.1			<0.01	<0.0005	
15-Oct-09	6.8	100	39					17.8	411	7.37	739		< 1	0.06	0.00315	0.2	0.14	<0.1		2.3			<0.01	<0.0005	
6-May-10	10.9	104	37.3					16.9	413	7.05	753		< 1	0.06	0.00141	0.18	0.12	<0.1		2.2			<0.01	<0.0005	
11-Nov-10	7.3	107	39.4					19	431	7.78	767		< 1	0.06	0.00263	0.2	0.14	<0.1		2.3			<0.01	<0.0005	
5-May-11	13.1	99.5	36.0					18.4	397	7.81	776		< 1	0.04	0.00174	0.10	0.06	<0.1		2.1			<0.01	0.0004	
5-May-11 *		106	38.3					18.3	423	7.83	776		< 1	< 0.01		0.13	<0.13	<0.1		2.1			<0.01	0.0003	
29-Sep-11	12.7	105	40.3					16.9	427	7.92	761		< 1	< 0.01	< 0.00014	0.14	<0.14	<0.1		2.3			0.03	0.0003	
19-Apr-12	14.5	80.4	33.0					18.9	337	8.14	719		< 1	< 0.01	< 0.02	0.17	0.17	<0.1		1.9			<0.01	0.0004	
19-Apr-12 *		80.9	33.3					19.0	339	8.14	721		< 1	< 0.01		0.15	0.15	<0.1		2.0			<0.01	0.0005	
3-Oct-12	15.5	68.2	39.6					27.8	333	8.22	675		< 1	0.24	< 0.02	1.17	0.93	<0.1		0.4			0.06	0.0021	
2-May-13	15.9	97.8	29.1					17.9	364	8.20	707		< 1	< 0.01	< 0.02	0.38	0.38	<0.1		0.1			0.03	0.0004	
3-Oct-13	11.1	94.6	36.0					17.4	385	7.93	652		< 1	< 0.01	< 0.02	0.26	0.26	<0.1		2.2			<0.01	0.0002	
7-May-14	12.2	92.5	33.4					23.5	368	8.17	697		< 1	0.04	< 0.02	0.34	0.30	<0.1		1.7			0.02	0.0004	
2-Oct-14	13.2	93.4	33.6					20.2	372	8.17	709		< 1	< 0.01	< 0.02	0.16	0.16	<0.1		2.0			0.01	0.0003	
6-May-15	15.9	92.7	33.5					23.5	370	8.18	694		< 1	< 0.01	< 0.02	0.3	0.3	<0.1		1.8			0.01	0.0003	
22-Sep-15	12.3	100.0	37.0					16.8	402	8.13	710		< 1	< 0.01	< 0.02	0.2	0.2	<0.1		2.1			<0.01	0.0002	
4-May-16	14.0	99.1	41.7					20.9	419	8.15	730		< 1	0.39	< 0.02	0.58	0.19	<0.1		1.6			<0.01	<0.0001	
4-May-16 *		93.4	39.4					20.7	395	8.18	743		< 1	0.39	< 0.02	0.61	0.22	<0.1		1.6			<0.01	<0.0001	
28-Sep-16	13.2	101	38.5					16.5	410	8.17	723		< 1	< 0.01	< 0.02	0.20	0.20	<0.1		1.9			<0.01	0.0002	
5-Jun-17	12.7	93.0	34.3					15.5	374	8.18	735		2	< 0.01	< 0.02	0.1	0.10	<0.05		1.5			<0.01	0.0003	
5-Jun-17 *		95.5	35.2					15.6	383	8.19	731		< 1	< 0.01		0.1	0.10	<0.05		1.5			<0.01	0.0003	
27-Sep-17	13.4	93.4	37.0					16.8	386	8.06	729		< 1	&											

**Historic Surface Water Quality Data
Sample SP5-88**

DATE	Temp (°C) (field)	Ca	Mg	Na	K	Alk. as CaCO3	SO4	Cl	Hardness as CaCO3	pH	Conduct.	Fe	Phenols	NH ₃ as N	Unionized Ammonia as NH ₃ ****	TKN as N	Organic Nitrogen	NO ₂ as N	NO ₃ as N	DOC	Mn	Total P	As	0-PO ₄
PWQO										6.5 - 8.5		0.3	1		0.02							0.03	0.005	
25-Nov-19	5	101	33.4			313	36	33.4	390	8.11	745	0.079	< 0.002	0.16		0.3	0.14	< 0.05	2.1			< 0.01	0.0002	
20-May-20		108	36.5	15.0	3.4	314	26	20.1	420	8.17	723	0.674	< 0.002	0.03	0.010	0.6	0.57	0.06	1.5			0.08	0.0004	
6-Nov-20		97.3	31.4	13.5	3.5	327	32	23.9	372	8.14	737	0.048	< 0.002	0.02	0.009	0.2	0.18	< 0.05	1.8			< 0.01	0.0002	
8-Apr-21	10	89.2	34.3	12.9	3.6	325	33	19.7	364	8.23	715	0.178	< 0.002	0.02	0.000	0.2	0.18	0.07	1.6	3.1		0.01	0.0003	
7-Oct-21	12	86.5	32.9	12.2	4.5	383	26	21.4	351	7.93	791	2.79	< 0.002	0.65	0.000	0.9	0.25	< 0.05	2.2			0.02	0.0008	
11-May-22	7	96	36.7	10.8	3.6	343	44	21.8	391	8.2	719	0.026	< 0.001	0.04	0.000	0.2		< 0.05	2.3	2.1		< 0.01	0.0002	
15-Sep-22	DRY																							
11-Apr-23	5	89.5	33.3	9.8	3.3	323	33	17.9	361	8.21	722	0.062	< 0.001	< 0.01	0.000	0.1		< 0.05	2.0	2.2		0.02	0.0002	
2-Nov-23	DRY																							
Average	12.8	96.08	39.76	13.7	4.595	313	49	16.21	404	7.90	728	0.07	2.2	0.206	0.01167	0.641	0.36	0.096	2.2	2.0	0.032	0.040	0.001	
Maximum	15.9	165	180	29.9	17.1	341	79.1	42.9	1154	8.32	1233	0.1	49	6.04	0.02000	11.1	5.06	0.2	3.5	3	0.032	0.48	0.0021	
Minimum	6.8	58.8	5.61	7.3	0.001	264	32	7.7	221	7.02	453	0.03	1	0.005	0.00014	0.1	0.06	0.01	0.1	1.5	0.032	0.003	0.0001	
Count	28	66	66	5	8	3	4	66	66	67	67	3	67	67	26	59	44	56	67	4	1	61	36	

* denotes duplicate sample

All results expressed as mg/L except the following parameters:

pH as -log [H⁺]

phenols as ppb

conductivity as µS/cm

****Fraction (f) of NH₃ where $f = 1 / (10^{pH - pKa} + 1)$; $pKa = 0.09018 + 2729.92 / T$; $T = °C + 273.16$

Surface Water Sample SP5-88

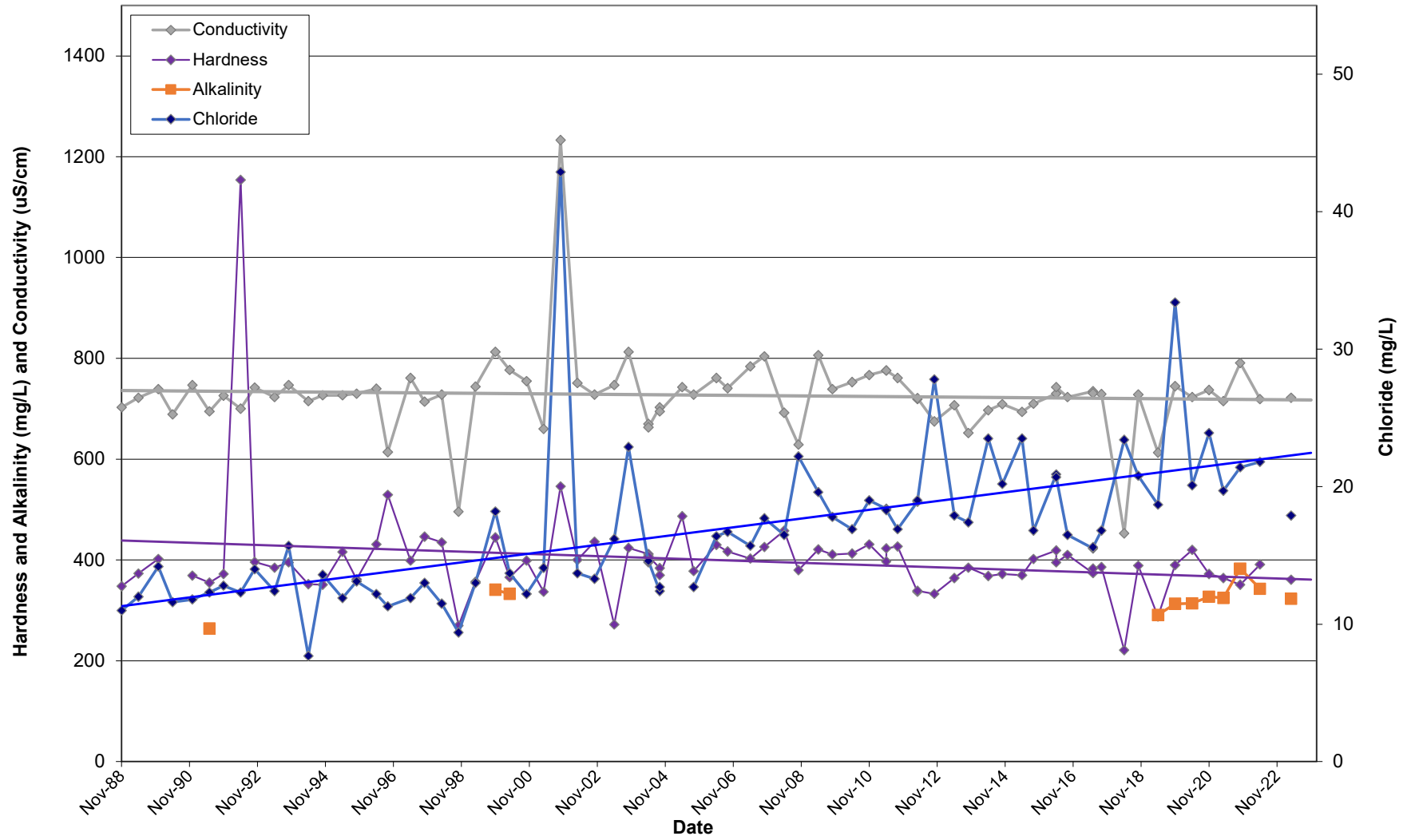

**Historic Surface Water Quality Data
Sample SS1-99**

DATE	Temp (°C) (field)	Ca	Mg	Na	K	Alk. as CaCO3	SO4	Cl	Hardness as CaCO3	pH	pH (field)	Conduct.	Conduct. (field)	Fe	Mn	NH ₃ as N	Unionized Ammonia as NH ₃ ****	TKN as N	Organic Nitrogen	NO ₂ as N	NO ₃ as N	DOC	Mn	Total P	As	0-PO ₄
PWQO										6.5 - 8.5	6.5 - 8.5			0.3	1		0.02							0.03	0.005	
13-Apr-00		99.2	33.2			275	19.1	7.9	384	8.05		594		0.08	< 1	< 0.01		0.31	0.30	<-0.1	2.4	5	0.021	0.01	0.005	
17-Oct-00		99.8	31.7						10.1	7.82		721			< 1	< 0.01		0.43	0.42	<-0.1	2.7			0.02		
24-Apr-01		83.2	26.3				15	12	316	7.98		636			< 1	0.15		0.72	0.57	<-0.1	5					
3-Oct-01		103	32.3	6.6	4.4			19.2	390	8.03		691			< 1	0.14		0.67	0.53	<-0.1	5.6					
18-Apr-02		85.6	27.2	5.9	4.4			9	326	7.98		604			< 1	0.01		0.43	0.42	<-0.1	5.8					
24-Oct-02 DRY																										
22-May-03		83.2	25.1					12.0	311	8.18		550			< 1	< 0.01		0.44	0.43	<-0.1	12.0			<0.01		
30-Oct-03		98.3	29.4					10.8	367	8.17		665			< 1	0.04		0.66	0.62	<-0.1	3.1			0.01		
20-May-04		87.4	24.5					8	319	8.19		525			< 1	0.02		0.39	0.37	<-0.1	4.8			<0.01	0.001	<0.01
30-Sep-04		66.9	20.6					3.3	252	8.25		495			< 1	0.03		0.26	0.23	<-0.1	3.5			<0.01	0.001	<0.01
5-May-05	7.1	107	39.7						431	8.19	8.6	652			< 1	< 0.01	0.00067	0.27	0.26	<-0.1	4.7			0.02	<0.001	<0.01
5-May-05 *		111	40.7						445	8.22		647	615		< 1	< 0.01		0.26	0.25	<-0.1	4.7			0.02	<0.001	<0.01
29-Sep-05	13	91.3	20.5						313	7.71	8	806	728		< 1	0.05	0.00138	1.28	1.23	<-0.1	1.4			0.17	<0.001	0.05
4-May-06	10	79	28.1					4.3	313	8.21	8.4	549	546		< 1	< 0.01	0.00054	0.49	0.48	<-0.1	6.1			0.02	<0.001	
28-Sep-06 Not flowing																										
10-May-07	8.7	77.7	24.5					10.9	295	8.19	8.0	569	567		< 1	0.01	0.00020	0.32	0.31	<-0.1	3			0.02	<0.0005	
4-Oct-07 DRY																										
15-May-08	10.0	96.4	33					11.2	377	7.52	8.3	634	637		< 1	0.02	0.00086	0.58	0.56	0.1	4.9			0.06	<0.0005	
2-Oct-08	11.6	76.1	21.5					6.6	278	8.3	7.5	480	472		< 1	< 0.01	< 0.00008	0.43		<-0.1	3			0.02	<0.0005	
21-May-09	11.3	94.1	33.7					6.1	374	7.95	8.7	681	613		< 1	< 0.01	< 0.00113	0.38	0.37	<-0.1	5.7			0.02	0.0008	
15-Oct-09	10.6	93.5	31.7					7.2	364	7.73	8.9	635	636		< 1	< 0.01	< 0.00162	0.28	0.27	<-0.1	5			0.02	<0.0005	
6-May-10	9.6	87.5	27.1					15.4	330	8.07	8.2	629	541		< 1	< 0.01	< 0.00033	0.33	0.32	<-0.1	4.1			0.03	<0.0005	
11-Nov-10	7.2	125	39.8					6.4	476	7.96	8.7	735	817		< 1	< 0.01	< 0.00084	0.26	0.25	<-0.1	2.2			0.03	<0.0005	
5-May-11	8.0	98.6	35.4					5.8	392	7.86	7.9	709	544		< 1	0.03	0.00045	0.26	0.23	<-0.1	3.5			<0.01	0.0004	
29-Sep-11 Not Flowing																										
19-Apr-12	10.8	60.9	23.2					4.0	248	8.18	8.1	547	562		< 1	< 0.01	< 0.02	0.28	0.28	<-0.1	0.5			0.02	0.0009	
3-Oct-12 DRY																										
2-May-13	9.2	81.7	27.4					5.7	317	8.28	7.71	560	515		< 1	< 0.01	< 0.02	0.35	0.35	<-0.1	4.4			<0.01	0.0001	
2-May-13 *		81.7	27.4					5.7	317	8.27		567			< 1	< 0.01		0.32	0.32	<-0.1	4.4			<0.01	0.0001	
3-Oct-13	12.9	81.9	25.6					5.3	310	7.81	7.34	510	502		< 1	< 0.01	< 0.02	0.34	0.34	<-0.1	<-0.1			0.04	0.0016	
7-May-14	7.5	78.9	27.7					7.2	311	8.24	8.11	573	589		< 1	< 0.01	< 0.02	0.22	0.22	<-0.1	3.9			<0.01	0.0002	
2-Oct-14	14.7	94.0	27.9					14.7	350	8.35	8.47	645	619		< 1	< 0.01	< 0.02	0.44	0.44	<-0.1	0.8			0.06	0.0006	
6-May-15	10.3	90.2	30.0					7.2	349	8.28	8.22	583	540		< 1	< 0.01	< 0.02	0.5	0.5	<-0.1	0.5			0.10	0.0005	
22-Sep-15 Not Flowing																										
4-May-16	10.3	80.4	33.9					3.3	340	8.24	8.20	595	624		< 1	< 0.01	< 0.02	0.28	0.28	<-0.1	0.5			0.01	<0.0001	
28-Sep-16 DRY																										
5-Jun-17	11.8	87.2	28.1					2.5	334	8.29	8.05	587	547		3	< 0.01	< 0.02	0.2	0.20	<0.05	1.84			0.03	0.0002	
27-Sep-17 DRY																										
15-May-18	13.2	90.0	32.1					9.6	357	8.06	7.81	664	661		< 1	1.40	0.03	2.8	1.4	0.3	8.80			0.13	0.0009	
3-Oct-18 DRY																										
30-May-19	9	110	36	12.8	4.4	349	33	19.7	423	8.07		771		0.667	< 0.002	0.51	< 0.02	0.5	0.01	< 0.05	1.90			0.03	0.0004	
25-Nov-19	7.5	104	34.5	13	4.7	343	31	22.7	402	7.88		777		0.81	< 0.002	0.51	< 0.02	0.6	0.09	<0.05	2.09			< 0.01	0.0004	
20-May-20		103	32.9	4.9	1.9	265	13	7.0	393	8.21		659		0.036	< 0.002	< 0.01	< 0.02	0.3	0.29	< 0.05	13.5			0.01	0.0001	
6-Nov-20		102	29.2	4.6	1.4	312	15	10.3	375	8.16		693		0.24	< 0.002	0.05	< 0.02	0.6	0.55	< 0.05	9.80			0.06	0.0002	
8-Apr-21	9	82.6	29.8	3.5	2.8	283	15	7.2	329	8.21		621		0.16	< 0.002	0.01	< 0.02	0.3	0.29	< 0.05	7.31			< 0.01	0.0002	
7-Oct-21	12	85.7	28.6	3.3	1.8	332	11	7.5	332	8.19		644		0.039	< 0.002	0.02	< 0.02	0.6	0.58	< 0.05	4.68			0.05	0.0003	
11-May-22	7	89.0	29.2	3.4	3.3	322	13	5.8	343	8.30		589		0.053	< 0.001	0.04	0.025	0.3		< 0.05	0.41	3.2		0.02	0.0003	
15-Sep-22 DRY																										
11-Apr-23	5	77.6	25.5	3.6	2.9	254	13	10.3	299	8.27		601		0.056	< 0.001	0.02	0.025	0.4		< 0.05	10.1	3.6		0.05	0.0002	
2-Nov-23	8	112	36	5.9		338	18	15	428	8.11		826		0.376	< 0.001	< 0.05	0.025	0.7		<0.05	25.8	3.9		0.06	0.0003	
Average	10.4	89.4	29.3	6.3	4.4	275.0	17.1	11.5	344.1	8.08	8.2	614.1	593.8	0.08	1.1	0.07	0.00970	0.49	0.43		4.0	5.0	0.021	0.04	0.001	0.05
Maximum	14.7	125.0	40.7	6.6	4.4	275.0	19.1	103.0	476.0	8.35	8.9	806.0	817.0	0.08	3.0	1.40	< 0.03	2.80	1.40		12.0	5.0	0.021	0.17	0.002	0.05
Minimum	7.1	60.9	20.5	5.9	4.4	275.0	15.0	2.5	248.0	7.52	7.3	480.0	472.0	0.08	1.0	0.01	0.00008	0.20	0.20		0.5	5.0	0.021	0.01	0.0001	0.05
Count	20	31	31	2	2	1	2	29	31	31	20	31	20	1	31	31										

Surface Water Sample SS1-99

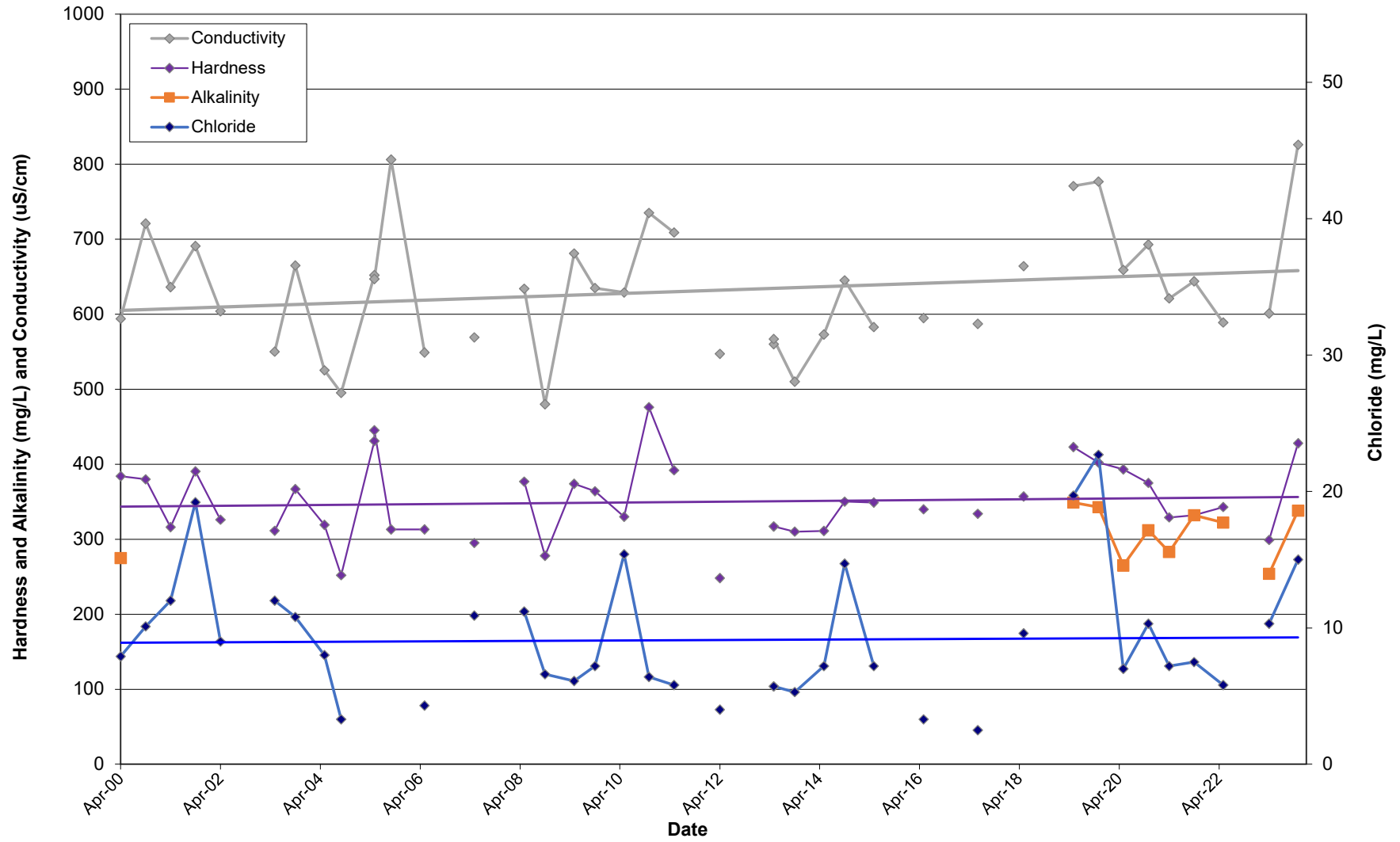

**APPENDIX G:
SUMMARY OF MONTHLY LEACHATE ANALYTICAL RESULTS**

Appendix G
Monthly Leachate Collection Quality Data

SW Outlet - Landfill																
Parameter	Date	3-Jan-23	13-Feb-23	6-Mar-23	11-Apr-23	8-May-23	13-Jun-23	4-Jul-23	17-Jul-23	8-Aug-23	14-Aug-23	5-Sep-23	3-Oct-23	6-Nov-23	23-Nov-23	Yearly Average
TSS		3.0	48	3.0	4.0	3.0	6.0	--	3.0	2.0	-	39	28	2.0	-	13
Phosphorus		<0.03	0.05	<0.03	<0.03	<0.03	<0.03	<0.03	<0.03	<0.03	-	<0.5	0.04	0.03	-	0.04
TKN		2.4	1.3	1.7	2.1	2.0	0.6	<0.5	<0.5	1.0	-	<0.5	0.5	0.9	-	1.4
COD		<8.0	18	<8.0	<8.0	8.0	<8.0	<8.0	9.0	<8.0	-	12	<8.0	<8.0	-	12
BOD		<4.0	<12.0	<12.0	<4.0	5.0	<4.0	<4.0	<4.0	<4.0	-	<12.0	<4.0	<4.0	-	5.0
Boron		-	-	-	-	0.11	-	-	-	-	0.07	-	-	-	0.04	0.07
Cobalt		-	-	-	-	0.0001	-	-	-	-	0.0001	-	-	-	0.0001	0.0001
Potassium		-	-	-	-	5.4	-	-	-	-	5.3	-	-	-	6.7	5.8
Magnesium		-	-	-	-	22	-	-	-	-	31	-	-	-	27	27
Manganese		-	-	-	-	0.08	-	-	-	-	0.03	-	-	-	0.009	0.04
Strontium		-	-	-	-	0.18	-	-	-	-	0.2	-	-	-	0.19	0.19
Bis(2-ethylhexyl)phthalate		-	-	-	-	<2.0	-	-	-	-	<2.0	-	-	-	<2.0	--

Notes:

1. Samples collected by Municipality of Arran-Elderslie staff and sent for analysis to SGS Canada Inc., a licensed laboratory
2. Concentrations are presented in Milligrams per Litre (mg/L).

**APPENDIX H:
LABORATORY CERTIFICATES OF ANALYSIS**

C.O.C.: G106164

REPORT No. B23-02885

Report To:

GM Blue Plan

1260 2nd Ave East,
 Owen Sound ON N4K 2J3

Attention: Jessica Weller

Caduceon Environmental Laboratories

112 Commerce Park Drive

Barrie ON L4N 8W8

Tel: 705-252-5743

Fax: 705-252-5746

DATE RECEIVED: 12-Apr-23

JOB/PROJECT NO.:

DATE REPORTED: 17-May-23

P.O. NUMBER: 219126

SAMPLE MATRIX: Groundwater

WATERWORKS NO.

Parameter	Units	R.L.	Reference Method	Date/Site Analyzed	Client I.D.	OW1 - 83	OW2 - 83	OW4 - 83	OW5 - 19
					Sample I.D.	Date Collected			
					B23-02885-1	11-Apr-23	B23-02885-2	B23-02885-3	B23-02885-4
							11-Apr-23	11-Apr-23	11-Apr-23
pH @25°C	pH Units		SM 4500H	13-Apr-23/O		8.17	8.38	7.87	7.77
Conductivity @25°C	µmho/cm	1	SM 2510B	13-Apr-23/O		558	461	761	728
Alkalinity(CaCO3) to pH4.5	mg/L	5	SM 2320B	13-Apr-23/O		153	200	304	363
Hardness (as CaCO3)	mg/L	1	SM 3120	14-Apr-23/O		194	253	325	425
Chloride	mg/L	0.5	SM4110C	14-Apr-23/O		87.0	9.8	60.7	1.4
Nitrite (N)	mg/L	0.05	SM4110C	14-Apr-23/O		< 0.05	< 0.05	< 0.05	< 0.05
Nitrate (N)	mg/L	0.05	SM4110C	14-Apr-23/O		0.05	0.28	0.11	0.22
Sulphate	mg/L	1	SM4110C	14-Apr-23/O		< 1	35	2	29
Ammonia (N)-Total	mg/L	0.01	SM4500-NH3-H	27-Apr-23/K		0.07	0.03	0.75	0.11
Total Kjeldahl Nitrogen	mg/L	0.1	E3516.2	17-Apr-23/K		0.2	0.1	0.9	0.5
Phosphorus-Total	mg/L	0.01	E3516.2	17-Apr-23/K		0.03	0.01	0.02	0.48
Phenolics	mg/L	0.001	MOEE 3179	18-Apr-23/K		< 0.001	< 0.001	< 0.001	< 0.001
Calcium	mg/L	0.02	SM 3120	14-Apr-23/O		11.5	13.4	90.0	117
Magnesium	mg/L	0.02	SM 3120	14-Apr-23/O		40.1	53.5	24.4	32.3
Potassium	mg/L	0.1	SM 3120	14-Apr-23/O		2.7	2.1	2.7	2.2
Sodium	mg/L	0.2	SM 3120	14-Apr-23/O		39.0	8.5	42.2	9.5
Arsenic	mg/L	0.0001	EPA 200.8	20-Apr-23/O		< 0.0001	< 0.0001	0.0001	0.0008
Iron	mg/L	0.005	SM 3120	14-Apr-23/O		2.00	0.225	12.6	4.72
Anion Sum	meq/L		Calc.	13-Apr-23/O		5.51	5.02	7.84	7.91
Cation Sum	meq/L		Calc.	13-Apr-23/O		5.75	5.51	9.10	9.22
% Difference	%		Calc.	13-Apr-23/O		2.12	4.58	7.45	7.66
Ion Ratio	AS/CS		Calc.	13-Apr-23/O		0.958	0.912	0.861	0.858
Sodium Adsorption Ratio	-		Calc.	13-Apr-23/O		1.22	0.233	1.02	0.201
TDS(ion sum calc.)	mg/L	1	Calc.	13-Apr-23/O		274	243	417	414



Christine Burke
 Lab Manager

R.L. = Reporting Limit

Test methods may be modified from specified reference method unless indicated by an *

Site Analyzed=K-Kingston,W-Windsor,O-Ottawa,R-Richmond Hill,B-Barrie

The analytical results reported herein refer to the samples as received. Reproduction of this analytical report in full or in part is prohibited without prior consent from

C.O.C.: G106164

REPORT No. B23-02885

Report To:

GM Blue Plan

1260 2nd Ave East,
 Owen Sound ON N4K 2J3

Attention: Jessica Weller

Caduceon Environmental Laboratories

112 Commerce Park Drive

Barrie ON L4N 8W8

Tel: 705-252-5743

Fax: 705-252-5746

DATE RECEIVED: 12-Apr-23

JOB/PROJECT NO.:

DATE REPORTED: 17-May-23

P.O. NUMBER: 219126

SAMPLE MATRIX: Groundwater

WATERWORKS NO.

Client I.D.	OW1 - 83	OW2 - 83	OW4 - 83	OW5 - 19
Sample I.D.	B23-02885-1	B23-02885-2	B23-02885-3	B23-02885-4
Date Collected	11-Apr-23	11-Apr-23	11-Apr-23	11-Apr-23

Parameter	Units	R.L.	Reference Method	Date/Site Analyzed				
Conductivity (calc.)	µmho/cm		Calc.	13-Apr-23/O	559	479	756	745
TDS(calc.)/EC(actual)	-		Calc.	13-Apr-23/O	0.491	0.527	0.548	0.568
EC(calc.)/EC(actual)	-		Calc.	13-Apr-23/O	1.00	1.04	0.993	1.02
Langelier Index(25°C)	S.I.		Calc.	13-Apr-23/O	-0.0295	0.377	0.845	0.935



Christine Burke
 Lab Manager

R.L. = Reporting Limit

Test methods may be modified from specified reference method unless indicated by an *

Site Analyzed=K-Kingston,W-Windsor,O-Ottawa,R-Richmond Hill,B-Barrie

The analytical results reported herein refer to the samples as received. Reproduction of this analytical report in full or in part is prohibited without prior consent from

C.O.C.: G106164

REPORT No. B23-02885

Report To:

GM Blue Plan

1260 2nd Ave East,
 Owen Sound ON N4K 2J3

Attention: Jessica Weller

Caduceon Environmental Laboratories

112 Commerce Park Drive

Barrie ON L4N 8W8

Tel: 705-252-5743

Fax: 705-252-5746

DATE RECEIVED: 12-Apr-23

JOB/PROJECT NO.:

DATE REPORTED: 17-May-23

P.O. NUMBER: 219126

SAMPLE MATRIX: Groundwater

WATERWORKS NO.

Parameter	Units	R.L.	Reference Method	Date/Site Analyzed	Client I.D.	OW6 - 19	TH4 - 02	TH7 - 81	TH8 - 81
					Sample I.D.	Date Collected	B23-02885-5	B23-02885-6	B23-02885-7
pH @25°C	pH Units		SM 4500H	13-Apr-23/O		7.53	7.77	8.02	7.95
Conductivity @25°C	µmho/cm	1	SM 2510B	13-Apr-23/O		1330	971	440	535
Alkalinity(CaCO3) to pH4.5	mg/L	5	SM 2320B	13-Apr-23/O		564	406	202	218
Hardness (as CaCO3)	mg/L	1	SM 3120	14-Apr-23/O		704	491	235	282
Chloride	mg/L	0.5	SM4110C	14-Apr-23/O		34.9	62.7	5.6	1.6
Nitrite (N)	mg/L	0.05	SM4110C	14-Apr-23/O		< 0.05	< 0.05	< 0.05	0.07
Nitrate (N)	mg/L	0.05	SM4110C	14-Apr-23/O		0.15	0.20	0.27	0.23
Sulphate	mg/L	1	SM4110C	14-Apr-23/O		136	19	21	64
Ammonia (N)-Total	mg/L	0.01	SM4500-NH3-H	27-Apr-23/K		0.12	0.13	0.02	0.24
Total Kjeldahl Nitrogen	mg/L	0.1	E3516.2	17-Apr-23/K		0.4	1.1	0.1	3.8
Phosphorus-Total	mg/L	0.01	E3516.2	17-Apr-23/K		0.42	0.13	0.05	3.50
Phenolics	mg/L	0.001	MOEE 3179	18-Apr-23/K		< 0.001	< 0.001	< 0.001	< 0.001
Calcium	mg/L	0.02	SM 3120	14-Apr-23/O		166	106	51.6	50.4
Magnesium	mg/L	0.02	SM 3120	14-Apr-23/O		70.4	54.7	25.7	37.9
Potassium	mg/L	0.1	SM 3120	14-Apr-23/O		2.6	1.5	1.5	1.3
Sodium	mg/L	0.2	SM 3120	14-Apr-23/O		49.9	35.0	13.1	14.5
Arsenic	mg/L	0.0001	EPA 200.8	20-Apr-23/O		0.0019	0.0016	0.0011	0.0037
Iron	mg/L	0.005	SM 3120	14-Apr-23/O		1.63	0.574	0.011	0.016
Anion Sum	meq/L		Calc.	13-Apr-23/O		15.1	10.3	4.66	5.80
Cation Sum	meq/L		Calc.	13-Apr-23/O		16.4	11.4	5.30	6.30
% Difference	%		Calc.	13-Apr-23/O		4.11	5.19	6.39	4.13
Ion Ratio	AS/CS		Calc.	13-Apr-23/O		0.921	0.901	0.880	0.921
Sodium Adsorption Ratio	-		Calc.	13-Apr-23/O		0.818	0.688	0.373	0.377
TDS(ion sum calc.)	mg/L	1	Calc.	13-Apr-23/O		801	523	240	302



Christine Burke
 Lab Manager

R.L. = Reporting Limit

Test methods may be modified from specified reference method unless indicated by an *

Site Analyzed=K-Kingston,W-Windsor,O-Ottawa,R-Richmond Hill,B-Barrie

The analytical results reported herein refer to the samples as received. Reproduction of this analytical report in full or in part is prohibited without prior consent from

C.O.C.: G106164

REPORT No. B23-02885

Report To:

GM Blue Plan

1260 2nd Ave East,
 Owen Sound ON N4K 2J3

Attention: Jessica Weller

Caduceon Environmental Laboratories

112 Commerce Park Drive
 Barrie ON L4N 8W8
 Tel: 705-252-5743
 Fax: 705-252-5746

DATE RECEIVED: 12-Apr-23

JOB/PROJECT NO.:

DATE REPORTED: 17-May-23

P.O. NUMBER: 219126

SAMPLE MATRIX: Groundwater

WATERWORKS NO.

Client I.D.	OW6 - 19	TH4 - 02	TH7 - 81	TH8 - 81
Sample I.D.	B23-02885-5	B23-02885-6	B23-02885-7	B23-02885-8
Date Collected	11-Apr-23	11-Apr-23	11-Apr-23	11-Apr-23

Parameter	Units	R.L.	Reference Method	Date/Site Analyzed				
Conductivity (calc.)	µmho/cm		Calc.	13-Apr-23/O	1319	971	459	554
TDS(calc.)/EC(actual)	-		Calc.	13-Apr-23/O	0.604	0.539	0.545	0.564
EC(calc.)/EC(actual)	-		Calc.	13-Apr-23/O	0.995	1.000	1.04	1.04
Langelier Index(25°C)	S.I.		Calc.	13-Apr-23/O	0.949	0.942	0.605	0.549



Christine Burke
 Lab Manager

R.L. = Reporting Limit

Test methods may be modified from specified reference method unless indicated by an *

Site Analyzed=K-Kingston,W-Windsor,O-Ottawa,R-Richmond Hill,B-Barrie

The analytical results reported herein refer to the samples as received. Reproduction of this analytical report in full or in part is prohibited without prior consent from

C.O.C.: G106164

REPORT No. B23-02885

Report To:

GM Blue Plan

1260 2nd Ave East,
 Owen Sound ON N4K 2J3

Attention: Jessica Weller

Caduceon Environmental Laboratories

112 Commerce Park Drive
 Barrie ON L4N 8W8
 Tel: 705-252-5743
 Fax: 705-252-5746

DATE RECEIVED: 12-Apr-23

JOB/PROJECT NO.:

DATE REPORTED: 17-May-23

P.O. NUMBER: 219126

SAMPLE MATRIX: Groundwater

WATERWORKS NO.

Client I.D.	OW3 - 83	TH6 - 81		
Sample I.D.	B23-02885-9	B23-02885-10		
Date Collected	11-Apr-23	11-Apr-23		

Parameter	Units	R.L.	Reference Method	Date/Site Analyzed				
pH @25°C	pH Units		SM 4500H	13-Apr-23/O	8.16	7.47		
Conductivity @25°C	µmho/cm	1	SM 2510B	13-Apr-23/O	454	1770		
Alkalinity(CaCO3) to pH4.5	mg/L	5	SM 2320B	13-Apr-23/O	217	544		
Hardness (as CaCO3)	mg/L	1	SM 3120	14-Apr-23/O	244	1170		
Chloride	mg/L	0.5	SM4110C	14-Apr-23/O	13.5	3.2		
Nitrite (N)	mg/L	0.05	SM4110C	14-Apr-23/O	< 0.05	< 0.05		
Nitrate (N)	mg/L	0.05	SM4110C	14-Apr-23/O	0.09	0.24		
Sulphate	mg/L	1	SM4110C	14-Apr-23/O	4	535		
Ammonia (N)-Total	mg/L	0.01	SM4500-NH3-H	27-Apr-23/K	0.09	0.08		
Total Kjeldahl Nitrogen	mg/L	0.1	E3516.2	17-Apr-23/K	0.2	0.5		
Phosphorus-Total	mg/L	0.01	E3516.2	17-Apr-23/K	0.07	0.37		
Phenolics	mg/L	0.001	MOEE 3179	18-Apr-23/K	< 0.001	< 0.001		
Calcium	mg/L	0.02	SM 3120	14-Apr-23/O	25.7	289		
Magnesium	mg/L	0.02	SM 3120	14-Apr-23/O	43.6	109		
Potassium	mg/L	0.1	SM 3120	14-Apr-23/O	2.3	2.8		
Sodium	mg/L	0.2	SM 3120	14-Apr-23/O	9.0	8.0		
Arsenic	mg/L	0.0001	EPA 200.8	20-Apr-23/O	< 0.0001	0.0003		
Iron	mg/L	0.005	SM 3120	14-Apr-23/O	0.340	0.205		
Anion Sum	meq/L		Calc.	13-Apr-23/O	4.79	22.1		
Cation Sum	meq/L		Calc.	13-Apr-23/O	5.34	23.9		
% Difference	%		Calc.	13-Apr-23/O	5.45	3.80		
Ion Ratio	AS/CS		Calc.	13-Apr-23/O	0.897	0.927		
Sodium Adsorption Ratio	-		Calc.	13-Apr-23/O	0.251	0.102		



Christine Burke
 Lab Manager

R.L. = Reporting Limit

Test methods may be modified from specified reference method unless indicated by an *

Site Analyzed=K-Kingston, W-Windsor, O-Ottawa, R-Richmond Hill, B-Barrie

The analytical results reported herein refer to the samples as received. Reproduction of this analytical report in full or in part is prohibited without prior consent from

C.O.C.: G106164

REPORT No. B23-02885

Report To:

GM Blue Plan

1260 2nd Ave East,
 Owen Sound ON N4K 2J3

Attention: Jessica Weller

Caduceon Environmental Laboratories

112 Commerce Park Drive
 Barrie ON L4N 8W8
 Tel: 705-252-5743
 Fax: 705-252-5746

DATE RECEIVED: 12-Apr-23

JOB/PROJECT NO.:

DATE REPORTED: 17-May-23

P.O. NUMBER: 219126

SAMPLE MATRIX: Groundwater

WATERWORKS NO.

Client I.D.	OW3 - 83	TH6 - 81		
Sample I.D.	B23-02885-9	B23-02885-10		
Date Collected	11-Apr-23	11-Apr-23		

Parameter	Units	R.L.	Reference Method	Date/Site Analyzed				
TDS(ion sum calc.)	mg/L	1	Calc.	13-Apr-23/O	228	1274		
Conductivity (calc.)	µmho/cm		Calc.	13-Apr-23/O	460	1800		
TDS(calc.)/EC(actual)	-		Calc.	13-Apr-23/O	0.502	0.721		
EC(calc.)/EC(actual)	-		Calc.	13-Apr-23/O	1.01	1.02		
Langelier Index(25°C)	S.I.		Calc.	13-Apr-23/O	0.473	1.15		



Christine Burke
 Lab Manager

R.L. = Reporting Limit

Test methods may be modified from specified reference method unless indicated by an *

Site Analyzed=K-Kingston,W-Windsor,O-Ottawa,R-Richmond Hill,B-Barrie

The analytical results reported herein refer to the samples as received. Reproduction of this analytical report in full or in part is prohibited without prior consent from

C.O.C.: G106161

REPORT No. B23-02886

Report To:

GM Blue Plan

1260 2nd Ave East,
 Owen Sound ON N4K 2J3

Attention: Jessica Weller

Caduceon Environmental Laboratories

112 Commerce Park Drive

Barrie ON L4N 8W8

Tel: 705-252-5743

Fax: 705-252-5746

DATE RECEIVED: 12-Apr-23

JOB/PROJECT NO.:

DATE REPORTED: 15-May-23

P.O. NUMBER: 219126

SAMPLE MATRIX: Surface Water

WATERWORKS NO.

Client I.D.	SP 2 - 85	SP 2A - 85	SP 3 - 85	SP 4 - 85
Sample I.D.	B23-02886-1	B23-02886-2	B23-02886-3	B23-02886-4
Date Collected	11-Apr-23	11-Apr-23	11-Apr-23	11-Apr-23

Parameter	Units	R.L.	Reference Method	Date/Site Analyzed	SP 2 - 85	SP 2A - 85	SP 3 - 85	SP 4 - 85
pH @25°C	pH Units		SM 4500H	14-Apr-23/O	8.20	8.20	8.24	8.27
Conductivity @25°C	µmho/cm	1	SM 2510B	14-Apr-23/O	684	678	387	390
Alkalinity(CaCO3) to pH4.5	mg/L	5	SM 2320B	14-Apr-23/O	295	305	189	189
Hardness (as CaCO3)	mg/L	1	SM 3120	18-Apr-23/O	329	336	196	203
Chloride	mg/L	0.5	SM4110C	14-Apr-23/O	37.1	32.4	6.1	6.1
Nitrite (N)	mg/L	0.05	SM4110C	14-Apr-23/O	< 0.05	< 0.05	< 0.05	< 0.05
Nitrate (N)	mg/L	0.05	SM4110C	14-Apr-23/O	1.64	1.20	0.63	0.63
Sulphate	mg/L	1	SM4110C	14-Apr-23/O	7	7	4	4
Dissolved Organic Carbon	mg/L	0.2	EPA 415.2	17-Apr-23/O	1.8	3.3	3.3	5.0
Ammonia (N)-Total	mg/L	0.01	SM4500-NH3-H	27-Apr-23/K	0.02	0.02	0.01	0.01
Total Kjeldahl Nitrogen	mg/L	0.1	E3516.2	17-Apr-23/K	0.2	0.2	0.2	0.2
Phosphorus-Total	mg/L	0.01	E3516.2	17-Apr-23/K	0.03	0.08	0.03	0.03
Phenolics	mg/L	0.001	MOEE 3179	17-Apr-23/K	< 0.001	< 0.001	< 0.001	< 0.001
Calcium	mg/L	0.02	SM 3120	18-Apr-23/O	94.7	96.7	46.4	47.9
Magnesium	mg/L	0.02	SM 3120	18-Apr-23/O	22.5	22.9	19.4	20.2
Potassium	mg/L	0.1	SM 3120	18-Apr-23/O	1.8	1.8	0.9	1.0
Sodium	mg/L	0.2	SM 3120	18-Apr-23/O	18.5	16.6	3.3	3.4
Arsenic	mg/L	0.0001	EPA 200.8	18-Apr-23/O	0.0006	0.0005	0.0002	0.0002
Iron	mg/L	0.005	SM 3120	18-Apr-23/O	0.282	0.366	0.071	0.067
Anion Sum	meq/L		Calc.	25-Apr-23/O	7.22	7.24	4.07	4.07
Cation Sum	meq/L		Calc.	25-Apr-23/O	7.45	7.50	4.09	4.23
% Difference	%		Calc.	25-Apr-23/O	1.58	1.74	0.175	1.91
Ion Ratio	AS/CS		Calc.	25-Apr-23/O	0.969	0.966	0.996	0.962
Sodium Adsorption Ratio	-		Calc.	25-Apr-23/O	0.444	0.394	0.103	0.104



Christine Burke
 Lab Manager

R.L. = Reporting Limit

Test methods may be modified from specified reference method unless indicated by an *

Site Analyzed=K-Kingston,W-Windsor,O-Ottawa,R-Richmond Hill,B-Barrie

The analytical results reported herein refer to the samples as received. Reproduction of this analytical report in full or in part is prohibited without prior consent from

C.O.C.: G106161

REPORT No. B23-02886

Report To:

GM Blue Plan

1260 2nd Ave East,
 Owen Sound ON N4K 2J3

Attention: Jessica Weller

Caduceon Environmental Laboratories

112 Commerce Park Drive

Barrie ON L4N 8W8

Tel: 705-252-5743

Fax: 705-252-5746

DATE RECEIVED: 12-Apr-23

JOB/PROJECT NO.:

DATE REPORTED: 15-May-23

P.O. NUMBER: 219126

SAMPLE MATRIX: Surface Water

WATERWORKS NO.

Client I.D.	SP 2 - 85	SP 2A - 85	SP 3 - 85	SP 4 - 85
Sample I.D.	B23-02886-1	B23-02886-2	B23-02886-3	B23-02886-4
Date Collected	11-Apr-23	11-Apr-23	11-Apr-23	11-Apr-23

Parameter	Units	R.L.	Reference Method	Date/Site Analyzed				
TDS(ion sum calc.)	mg/L	1	Calc.	25-Apr-23/O	359	361	193	196
Conductivity (calc.)	µmho/cm		Calc.	25-Apr-23/O	674	675	376	382
TDS(calc.)/EC(actual)	-		Calc.	25-Apr-23/O	0.525	0.532	0.500	0.502
EC(calc.)/EC(actual)	-		Calc.	25-Apr-23/O	0.985	0.995	0.971	0.980
Langelier Index(25°C)	S.I.		Calc.	25-Apr-23/O	1.19	1.22	0.761	0.804



Christine Burke
 Lab Manager

R.L. = Reporting Limit

Test methods may be modified from specified reference method unless indicated by an *

Site Analyzed=K-Kingston,W-Windsor,O-Ottawa,R-Richmond Hill,B-Barrie

The analytical results reported herein refer to the samples as received. Reproduction of this analytical report in full or in part is prohibited without prior consent from

C.O.C.: G106161

REPORT No. B23-02886

Report To:

GM Blue Plan

1260 2nd Ave East,
 Owen Sound ON N4K 2J3

Attention: Jessica Weller

Caduceon Environmental Laboratories

112 Commerce Park Drive

Barrie ON L4N 8W8

Tel: 705-252-5743

Fax: 705-252-5746

DATE RECEIVED: 12-Apr-23

JOB/PROJECT NO.:

DATE REPORTED: 15-May-23

P.O. NUMBER: 219126

SAMPLE MATRIX: Surface Water

WATERWORKS NO.

Client I.D.	SP 5 - 88	SP 1- 83	SS1 - 99	
Sample I.D.	B23-02886-5	B23-02886-6	B23-02886-7	
Date Collected	11-Apr-23	11-Apr-23	11-Apr-23	

Parameter	Units	R.L.	Reference Method	Date/Site Analyzed				
pH @25°C	pH Units		SM 4500H	14-Apr-23/O	8.21	8.07	8.27	
Conductivity @25°C	µmho/cm	1	SM 2510B	14-Apr-23/O	722	811	601	
Alkalinity(CaCO3) to pH4.5	mg/L	5	SM 2320B	14-Apr-23/O	323	373	254	
Hardness (as CaCO3)	mg/L	1	SM 3120	18-Apr-23/O	361	442	299	
Chloride	mg/L	0.5	SM4110C	14-Apr-23/O	17.9	22.6	10.3	
Nitrite (N)	mg/L	0.05	SM4110C	14-Apr-23/O	< 0.05	< 0.05	< 0.05	
Nitrate (N)	mg/L	0.05	SM4110C	14-Apr-23/O	2.00	1.70	10.1	
Sulphate	mg/L	1	SM4110C	14-Apr-23/O	33	23	13	
Dissolved Organic Carbon	mg/L	0.2	EPA 415.2	17-Apr-23/O	2.2	2.7	3.6	
Ammonia (N)-Total	mg/L	0.01	SM4500-NH3-H	27-Apr-23/K	< 0.01	1.07	0.02	
Total Kjeldahl Nitrogen	mg/L	0.1	E3516.2	17-Apr-23/K	0.1	2.3	0.4	
Phosphorus-Total	mg/L	0.01	E3516.2	17-Apr-23/K	0.02	0.16	0.05	
Phenolics	mg/L	0.001	MOEE 3179	17-Apr-23/K	< 0.001	< 0.001	< 0.001	
Calcium	mg/L	0.02	SM 3120	18-Apr-23/O	89.5	112	77.6	
Magnesium	mg/L	0.02	SM 3120	18-Apr-23/O	33.3	36.7	25.5	
Potassium	mg/L	0.1	SM 3120	18-Apr-23/O	3.3	5.2	2.9	
Sodium	mg/L	0.2	SM 3120	18-Apr-23/O	9.8	13.7	3.6	
Arsenic	mg/L	0.0001	EPA 200.8	18-Apr-23/O	0.0002	0.0106	0.0002	
Iron	mg/L	0.005	SM 3120	18-Apr-23/O	0.062	< 0.005	0.056	
Anion Sum	meq/L		Calc.	25-Apr-23/O	7.79	8.67	6.36	
Cation Sum	meq/L		Calc.	25-Apr-23/O	7.72	9.46	6.21	
% Difference	%		Calc.	25-Apr-23/O	0.429	4.32	1.20	
Ion Ratio	AS/CS		Calc.	25-Apr-23/O	1.01	0.917	1.02	
Sodium Adsorption Ratio	-		Calc.	25-Apr-23/O	0.225	0.305	0.0914	



Christine Burke
 Lab Manager

R.L. = Reporting Limit

Test methods may be modified from specified reference method unless indicated by an *

Site Analyzed=K-Kingston,W-Windsor,O-Ottawa,R-Richmond Hill,B-Barrie

The analytical results reported herein refer to the samples as received. Reproduction of this analytical report in full or in part is prohibited without prior consent from

C.O.C.: G106161

REPORT No. B23-02886

Report To:

GM Blue Plan

1260 2nd Ave East,
 Owen Sound ON N4K 2J3

Attention: Jessica Weller

Caduceon Environmental Laboratories

112 Commerce Park Drive

Barrie ON L4N 8W8

Tel: 705-252-5743

Fax: 705-252-5746

DATE RECEIVED: 12-Apr-23

JOB/PROJECT NO.:

DATE REPORTED: 15-May-23

P.O. NUMBER: 219126

SAMPLE MATRIX: Surface Water

WATERWORKS NO.

Client I.D.	SP 5 - 88	SP 1- 83	SS1 - 99	
Sample I.D.	B23-02886-5	B23-02886-6	B23-02886-7	
Date Collected	11-Apr-23	11-Apr-23	11-Apr-23	

Parameter	Units	R.L.	Reference Method	Date/Site Analyzed				
TDS(ion sum calc.)	mg/L	1	Calc.	25-Apr-23/O	381	439	285	
Conductivity (calc.)	µmho/cm		Calc.	25-Apr-23/O	694	806	539	
TDS(calc.)/EC(actual)	-		Calc.	25-Apr-23/O	0.528	0.541	0.475	
EC(calc.)/EC(actual)	-		Calc.	25-Apr-23/O	0.962	0.994	0.896	
Langelier Index(25°C)	S.I.		Calc.	25-Apr-23/O	1.22	1.23	1.12	



Christine Burke
 Lab Manager

R.L. = Reporting Limit

Test methods may be modified from specified reference method unless indicated by an *

Site Analyzed=K-Kingston,W-Windsor,O-Ottawa,R-Richmond Hill,B-Barrie

The analytical results reported herein refer to the samples as received. Reproduction of this analytical report in full or in part is prohibited without prior consent from

C.O.C.: G106164/G106161

REPORT No. B23-02887

Report To:

GM Blue Plan

1260 2nd Ave East,
 Owen Sound ON N4K 2J3

Attention: Jessica Weller

Caduceon Environmental Laboratories

112 Commerce Park Drive

Barrie ON L4N 8W8

Tel: 705-252-5743

Fax: 705-252-5746

DATE RECEIVED: 12-Apr-23

JOB/PROJECT NO.:

DATE REPORTED: 15-May-23

P.O. NUMBER: 219126

SAMPLE MATRIX: Leachate

WATERWORKS NO.

Client I.D.	MH 7A	MH 8	LW 1 - II	
Sample I.D.	B23-02887-1	B23-02887-2	B23-02887-3	
Date Collected	11-Apr-23	11-Apr-23	11-Apr-23	

Parameter	Units	R.L.	Reference Method	Date/Site Analyzed				
pH @25°C	pH Units		SM 4500H	13-Apr-23/O	7.92	7.96	7.54	
Conductivity @25°C	µmho/cm	1	SM 2510B	13-Apr-23/O	747	745	926	
Hardness (as CaCO3)	mg/L	1	SM 3120	14-Apr-23/O	345	393	465	
Chloride	mg/L	0.5	SM4110C	14-Apr-23/O	17.5	17.5	26.4	
Nitrite (N)	mg/L	0.05	SM4110C	14-Apr-23/O	< 0.05	0.09	< 0.05	
Nitrate (N)	mg/L	0.05	SM4110C	14-Apr-23/O	2.64	2.61	0.12	
BOD(5 day)	mg/L	3	SM 5210B	19-Apr-23/K	< 3	< 3	< 3	
COD	mg/L	5	SM5220C	14-Apr-23/K	< 5	< 5	40	
Dissolved Organic Carbon	mg/L	0.2	EPA 415.2	13-Apr-23/O	1.7	2.9	6.6	
Ammonia (N)-Total	mg/L	0.01	SM4500-NH3-H	27-Apr-23/K	1.12	1.81	2.51	
Total Kjeldahl Nitrogen	mg/L	0.1	E3516.2	18-Apr-23/K	1.5	1.9	2.7	
Phosphorus-Total	mg/L	0.01	E3516.2	18-Apr-23/K	0.02	0.02	0.51	
Phenolics	mg/L	0.001	MOEE 3179	17-Apr-23/K	< 0.001	0.001	0.006	
Calcium	mg/L	0.02	SM 3120	14-Apr-23/O	84.7	95.5	127	
Magnesium	mg/L	0.02	SM 3120	14-Apr-23/O	32.4	37.4	35.8	
Potassium	mg/L	0.1	SM 3120	14-Apr-23/O	4.0	4.5	6.9	
Sodium	mg/L	0.2	SM 3120	14-Apr-23/O	12.0	12.9	19.3	
Anion Sum	meq/L		Calc.	13-Apr-23/O	7.79	7.86	9.82	
Cation Sum	meq/L		Calc.	13-Apr-23/O	7.53	8.54	10.4	
% Difference	%		Calc.	13-Apr-23/O	1.70	4.16	3.07	
Ion Ratio	AS/CS		Calc.	13-Apr-23/O	1.03	0.920	0.940	
Sodium Adsorption Ratio	-		Calc.	13-Apr-23/O	0.280	0.282	0.390	
TDS(ion sum calc.)	mg/L	1	Calc.	13-Apr-23/O	375	394	501	
Conductivity (calc.)	µmho/cm		Calc.	13-Apr-23/O	681	728	892	



Christine Burke
 Lab Manager

R.L. = Reporting Limit

Test methods may be modified from specified reference method unless indicated by an *

Site Analyzed=K-Kingston, W-Windsor, O-Ottawa, R-Richmond Hill, B-Barrie

The analytical results reported herein refer to the samples as received. Reproduction of this analytical report in full or in part is prohibited without prior consent from

C.O.C.: G106164/G106161

REPORT No. B23-02887

Report To:

GM Blue Plan

1260 2nd Ave East,
 Owen Sound ON N4K 2J3

Attention: Jessica Weller

Caduceon Environmental Laboratories

112 Commerce Park Drive
 Barrie ON L4N 8W8

Tel: 705-252-5743

Fax: 705-252-5746

DATE RECEIVED: 12-Apr-23

JOB/PROJECT NO.:

DATE REPORTED: 15-May-23

P.O. NUMBER: 219126

SAMPLE MATRIX: Leachate

WATERWORKS NO.

Client I.D.	MH 7A	MH 8	LW 1 - II	
Sample I.D.	B23-02887-1	B23-02887-2	B23-02887-3	
Date Collected	11-Apr-23	11-Apr-23	11-Apr-23	

Parameter	Units	R.L.	Reference Method	Date/Site Analyzed				
TDS(calc.)/EC(actual)	-		Calc.	13-Apr-23/O	0.502	0.529	0.541	
EC(calc.)/EC(actual)	-		Calc.	13-Apr-23/O	0.912	0.977	0.963	
Langelier Index(25°C)	S.I.		Calc.	13-Apr-23/O	0.908	1.00	0.811	



Christine Burke
 Lab Manager

R.L. = Reporting Limit

Test methods may be modified from specified reference method unless indicated by an *

Site Analyzed=K-Kingston,W-Windsor,O-Ottawa,R-Richmond Hill,B-Barrie

The analytical results reported herein refer to the samples as received. Reproduction of this analytical report in full or in part is prohibited without prior consent from